



Høgskolen i Telemark

Telemark University College

Department of Electrical Engineering, Information Technology and Cybernetics



Introduction to Visual Studio and C#

HANS-PETTER HALVORSEN, 2014.03.12

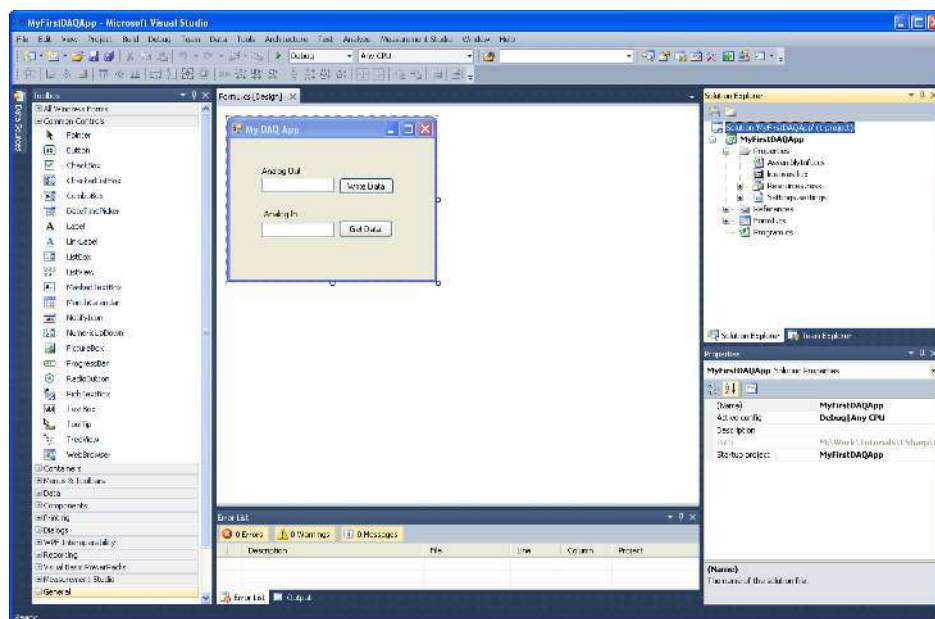

Faculty of Technology, Postboks 203, Kjølnes ring 56, N-3901 Porsgrunn, Norway. Tel: +47 35 57 50 00 Fax: +47 35 57 54 01

Table of Contents

1. Introduction	5
1.1. Visual Studio	5
1.2. C#	6
1.3. .NET Framework.....	6
1.4. Object-Oriented Programming (OOP).....	7
2. Visual Studio	8
2.1. Introduction	8
2.2. Getting Started	8
2.2.1. Integrated Development Environment (IDE)	8
2.2.2. New Project.....	9
2.2.3. Solution Explorer.....	10
2.2.4. Toolbox	11
2.2.5. Editors and Designers	12
2.2.6. Properties window.....	12
2.2.7. Build and Debug Tools	13
3. Windows Programming	15
3.1. Introduction	15
3.1.1. Windows Forms	15
3.1.2. WPF.....	16
3.2. Hello World.....	16
4. Getting Started with C#	19

4.1. Introduction	19
4.2. Data Types and Variables.....	19
4.2.1. Boolean type	20
4.2.2. Numeric types: Integrals, Floating Point, Decimal	20
4.2.3. String type.....	20
4.2.4. Arrays.....	21
4.3. Control Flow.....	21
4.3.1. The if Statement	21
4.3.2. The switch Statement	22
4.4. Loops.....	23
4.4.1. The while Loop.....	23
4.4.2. The do Loop	23
4.4.3. The for Loop.....	24
4.4.4. The foreach Loop	24
4.5. Methods.....	24
4.5.1. Nonstatic Methods	25
4.5.2. Static Methods.....	25
4.6. Namespaces.....	26
4.7. Classes.....	26
4.7.1. Constructor	27
4.8. Properties	29
4.9. Naming Convention	31
5. More Object-oriented Techniques.....	33
5.1. Inheritance.....	33
5.2. Polymorphism.....	34
5.3. Encapsulation.....	35

6. Exception Handling	36
7. Windows Forms Example.....	38
8. Web Programming.....	44
8.1. Introduction	44
8.2. HTML.....	44
8.3. Web Browser	44
8.4. CSS	45
8.5. JavaScript	45
8.6. ASP.NET.....	45
8.7. AJAX/ ASP.NET AJAX	46
8.8. Silverlight	46
9. Database Programming	47
9.1. ADO.NET	47

1. Introduction

In this Tutorial we will use Visual Studio and C#. C# is the programming language, while Visual Studio is the development environment.

Useful links:

Visual Studio: <http://msdn.microsoft.com/en-us/library/dd831853.aspx>

C#: <http://msdn.microsoft.com/en-us/library/kx37x362.aspx>

1.1. Visual Studio

Microsoft Visual Studio is an integrated development environment (IDE) from Microsoft. It can be used to develop console and graphical user interface applications along with Windows Forms applications, web sites, web applications, and web services in both native code together with managed code for all platforms supported by Microsoft Windows, Windows Phone, Windows CE, .NET Framework, .NET Compact Framework and Microsoft Silverlight.

Below we see the integrated development environment (IDE) in Visual Studio:

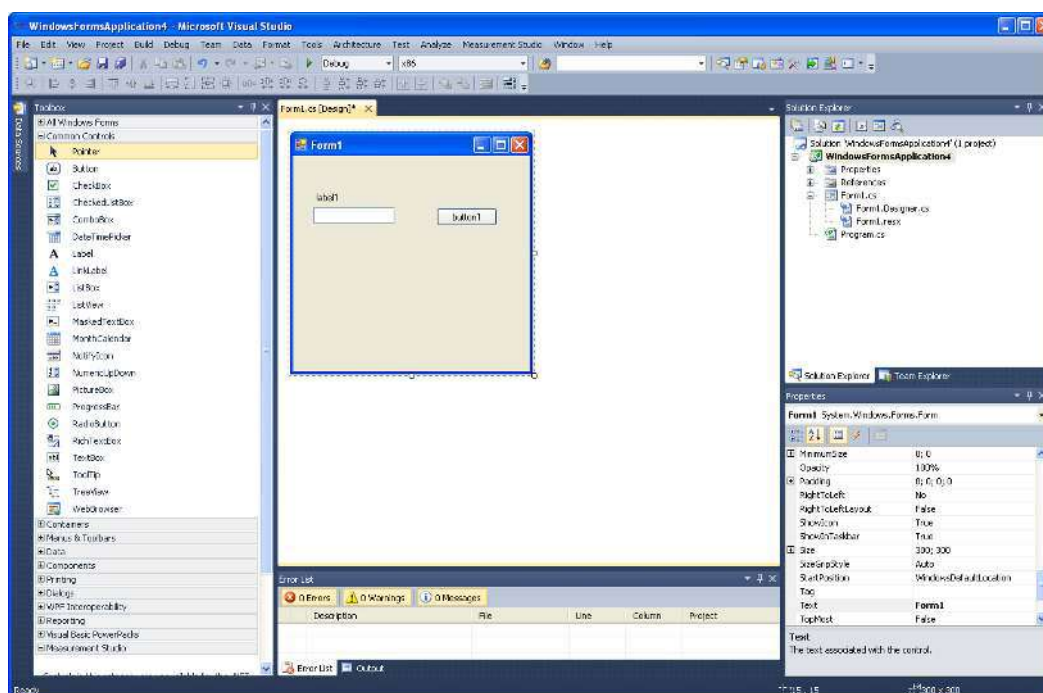

New projects are created from the “New Project” window:

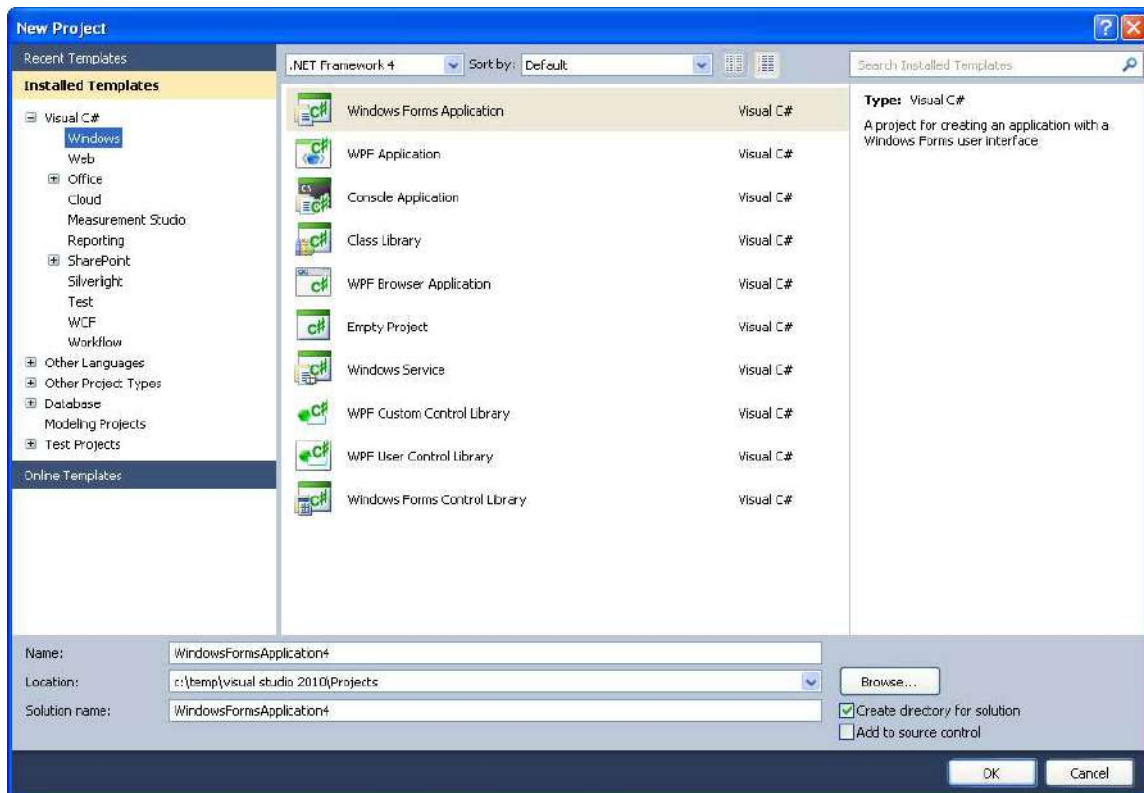

1.2. C#

C# is pronounced “see sharp”. C# is an object-oriented programming language and part of the .NET family from Microsoft. C# is very similar to C++ and Java. C# is developed by Microsoft and works only on the Windows platform.

1.3. .NET Framework

The .NET Framework (pronounced “dot net”) is a software framework that runs primarily on Microsoft Windows. It includes a large library and supports several programming languages which allow language interoperability (each language can use code written in other languages). The .NET library is available to all the programming languages that .NET supports. Programs written for the .NET Framework execute in a software environment, known as the Common Language Runtime (CLR), an application virtual machine that provides important services such as security, memory management, and exception handling. The class library and the CLR together constitute the .NET Framework.

1.4. Object-Oriented Programming (OOP)

Object-oriented programming (OOP) is a programming language model organized around "objects" rather than "actions" and data rather than logic. Historically, a program has been viewed as a logical procedure that takes input data, processes it, and produces output data.

The first step in OOP is to identify all the objects you want to manipulate and how they relate to each other, an exercise often known as data modeling. Once you've identified an object, you generalize it as a class of objects and define the kind of data it contains and any logic sequences that can manipulate it. Each distinct logic sequence is known as a method. A real instance of a class is called an "object" or an "instance of a class". The object or class instance is what you run in the computer. Its methods provide computer instructions and the class object characteristics provide relevant data. You communicate with objects - and they communicate with each other.

Important features with OOP are:

- Classes and Objects
- Inheritance
- Polymorphism
- Encapsulation

Simula was the first object-oriented programming language. Simula was developed in the 1960s by Kristen Nygaard from Norway.

Java, Python, C++, Visual Basic .NET and C# are popular OOP languages today.

Since Simula-type objects are reimplemented in C++, Java and C# the influence of Simula is often understated. The creator of C++ (1979), Bjarne Stroustrup (from Denmark), has acknowledged that Simula was the greatest influence on him to develop C++.

2. Visual Studio

2.1. Introduction

Home page of Visual Studio: <http://www.microsoft.com/visualstudio>

There exist different versions of Visual Studio, such as Visual Studio Express (free), Visual Studio Professional, Visual Studio Premium and Visual Studio Ultimate.

2.2. Getting Started

2.2.1. Integrated Development Environment (IDE)

The Visual Studio product family shares a single integrated development environment (IDE) that is composed of several elements: the Menu bar, Standard toolbar, various tool windows docked or auto-hidden on the left, bottom, and right sides, as well as the editor space. The tool windows, menus, and toolbars available depend on the type of project or file you are working in.

Below we see the Visual Studio IDE (Integrated Development Environment):



2.2.2. New Project

The first thing you do when you want to create a new application is to create a new project.

This can be done from the Start Page:

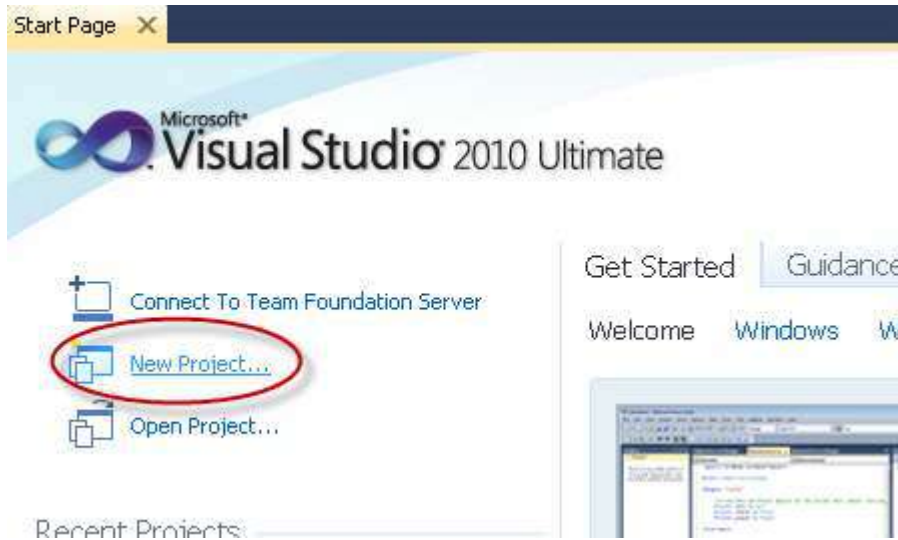

Or from the File menu:

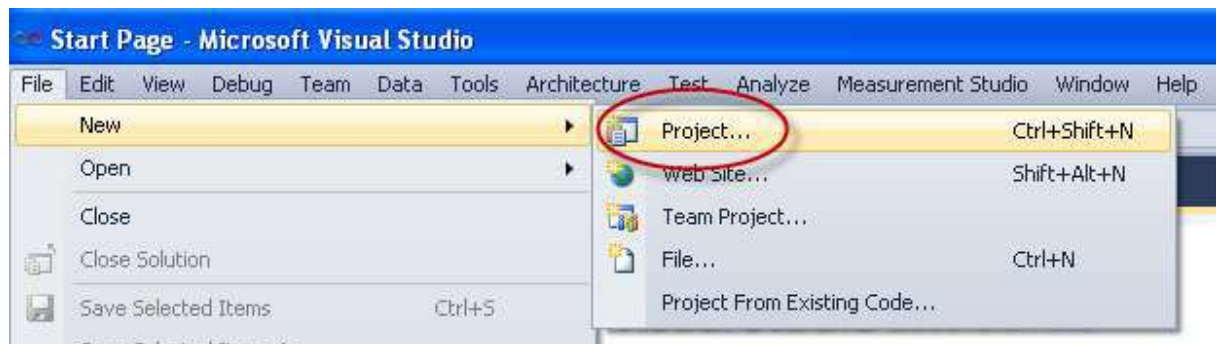

Then the “New Project” window appears:

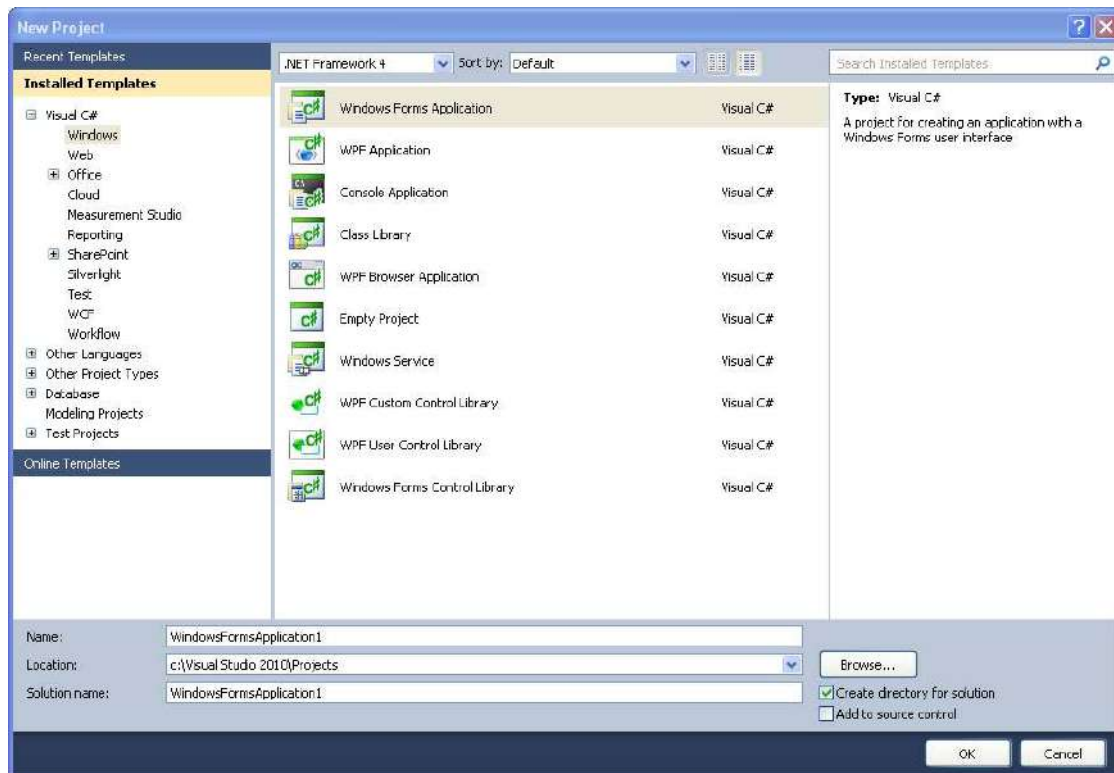

In this window you will select an appropriate template based on what kind of application you want to create, and a name and location for your project and solution.

The most common applications are:

- Windows Form Application
- Console Application
- WPF Application
- ASP.NET Web Application
- Silverlight Application

2.2.3. Solution Explorer

Solutions and projects contain items that represent the references, data connections, folders, and files that you need to create your application. A solution container can contain multiple projects and a project container typically contains multiple items.

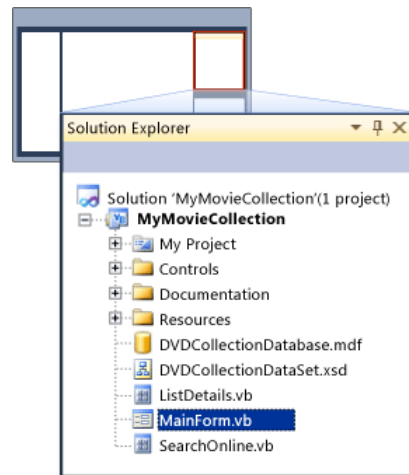

2.2.4. Toolbox

The Toolbox contains all the necessary controls, etc. you need to create your user interface. See Figure below.

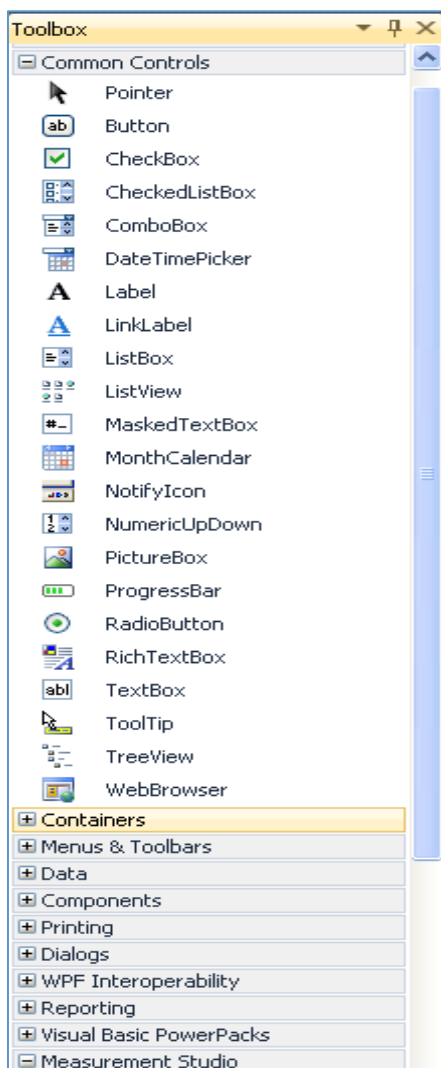

The Toolbox contains all the controls, etc. we can use in our user interface.

In order to use them in our user interface, we just drag and drop them to the "Form", as shown below:

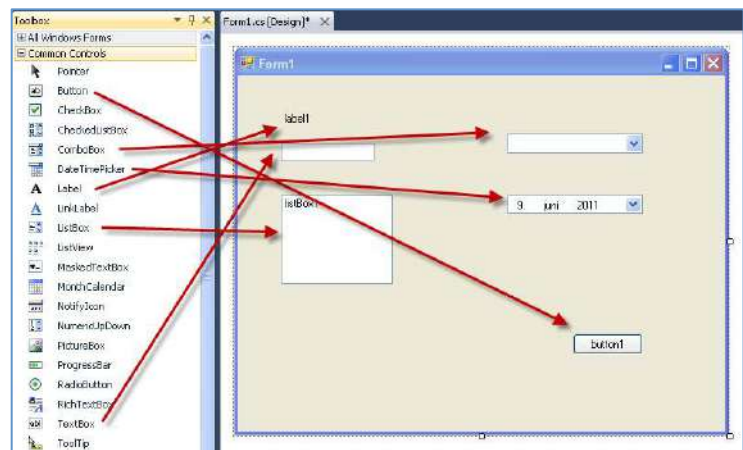

2.2.5. Editors and Designers

Visual Studio has different editors and design tools.

Graphical User Interface Designer:

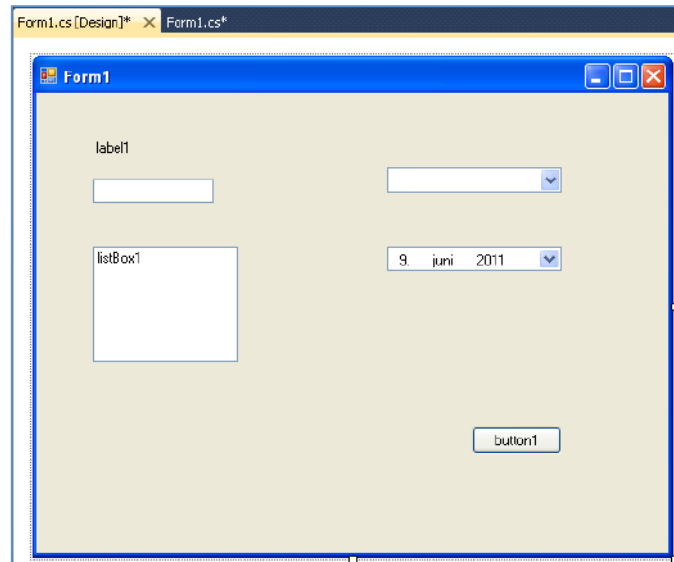

Code Editor:

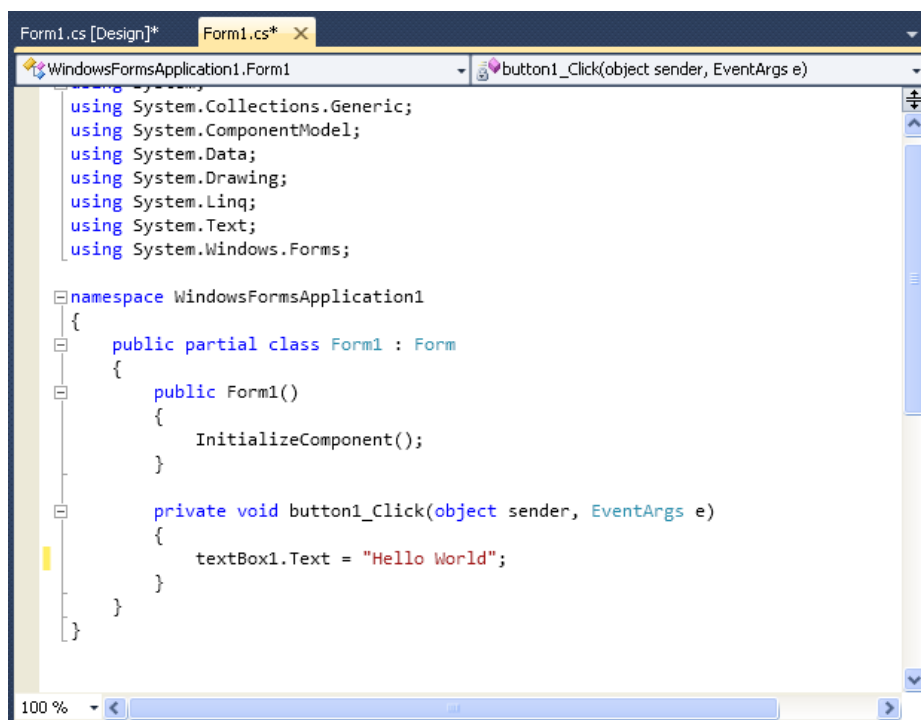

2.2.6. Properties window

Each control we have on our user interface has lots of Properties we can set.

This is done in the Properties window:

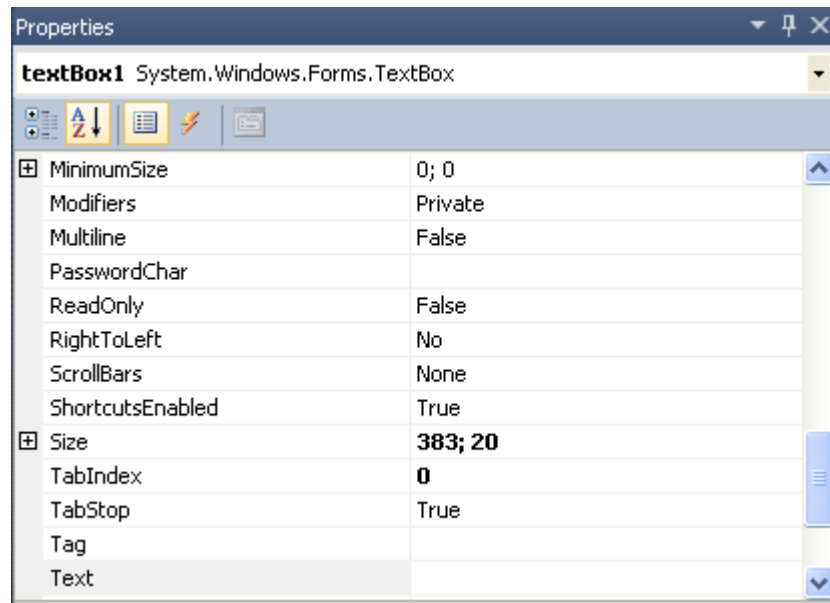

2.2.7. Build and Debug Tools

In Visual Studio we have lots of Build and Debugging Tools.

Build menu:

Below we see the **Build** menu:

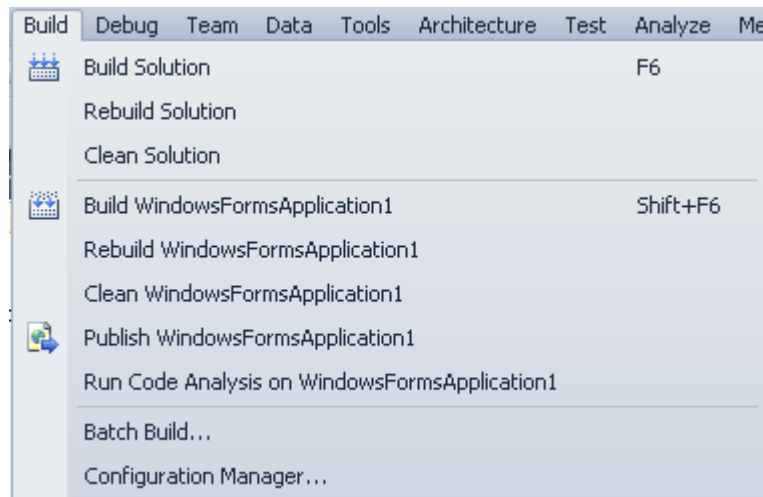

The most used tool is “**Build Solution**” (Shortcut Key: F6).

Debug menu:

Below we see the **Debug** menu:

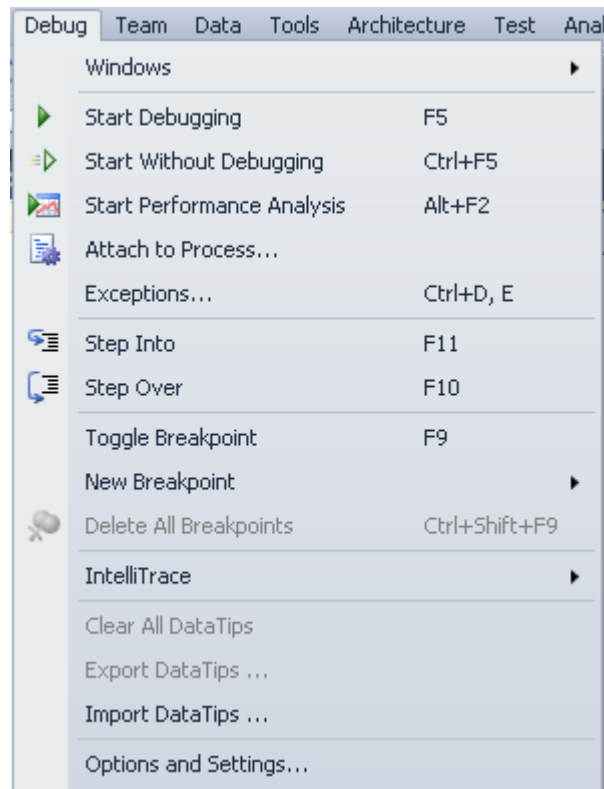

The most used tool is “**Start Debugging**” (Shortcut Key: F5).

3. Windows Programming

3.1. Introduction

When creating ordinary Windows applications, we can select between the following:

- Windows Forms Application
- WPF Applications (Windows Presentation Foundation)

Windows Forms is the standard way of creating Windows applications and has existed in many years, even before .NET 1.0 (2002) was introduced. WPF is a new approach from creating Windows applications and was introduced with .NET Framework 3.0 (2006).

For example has the Visual Studio IDE been entirely rewritten using WPF.

Windows Forms Application and WPF Applications will be explained in more detail below.

3.1.1. Windows Forms

Windows Forms is the standard way of creating Windows applications.

Select “Windows Forms Application” in the “New Project” window:

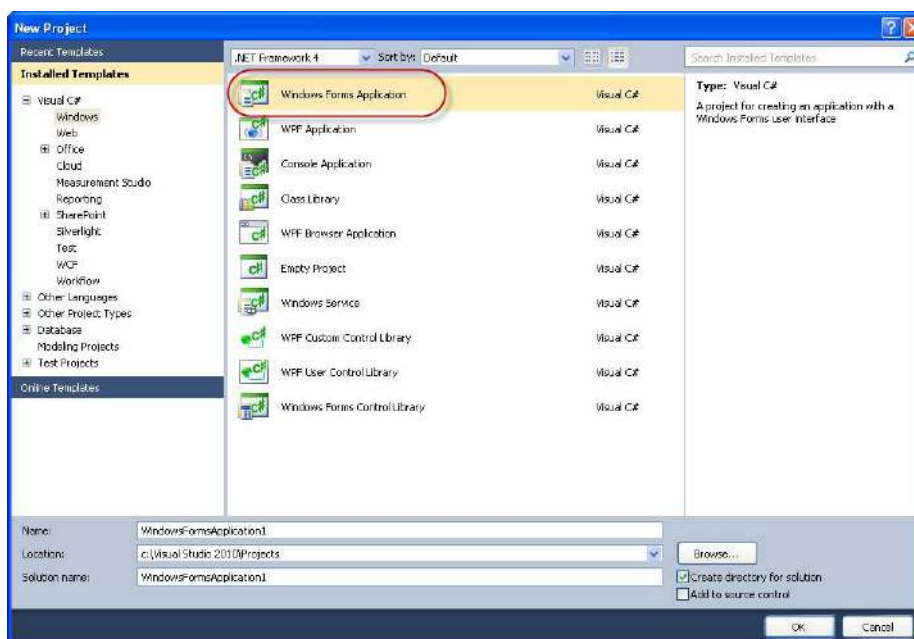

3.1.2. WPF

Developed by Microsoft, the Windows Presentation Foundation (or WPF) is a computer-software graphical subsystem for rendering user interfaces in Windows-based applications.

WPF is intended to take over for the traditional Windows Forms.

The graphical user interface in WPF is designed using **XAML** (Extensible Application Markup Language).

XAML:

Following the success of markup languages for web development, WPF introduces a new language known as eXtensible Application Markup Language (XAML), which is based on XML. XAML is designed as a more efficient method of developing application user interfaces

Select “WPF Application” in the “New Project” window:

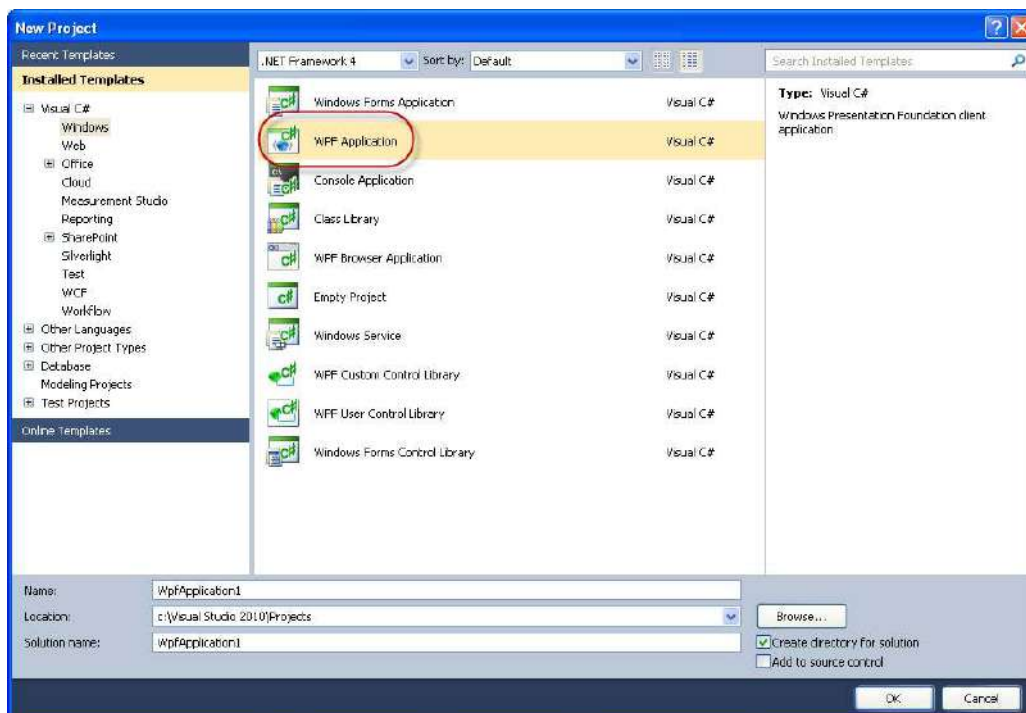

3.2. Hello World

We start by creating a traditional “Hello World” application using Windows Forms. The application is shown below:

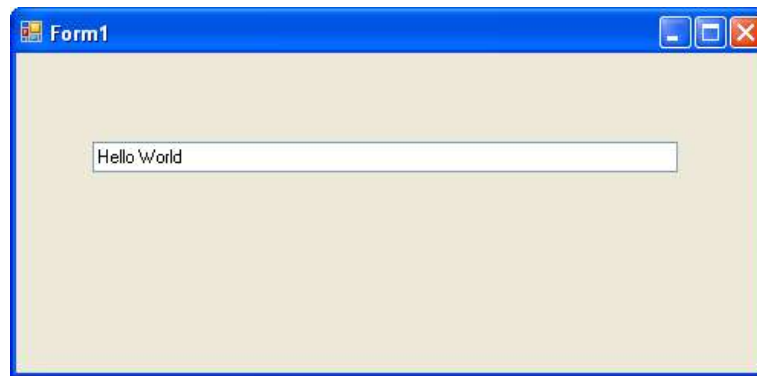

The Visual Studio IDE looks like this:

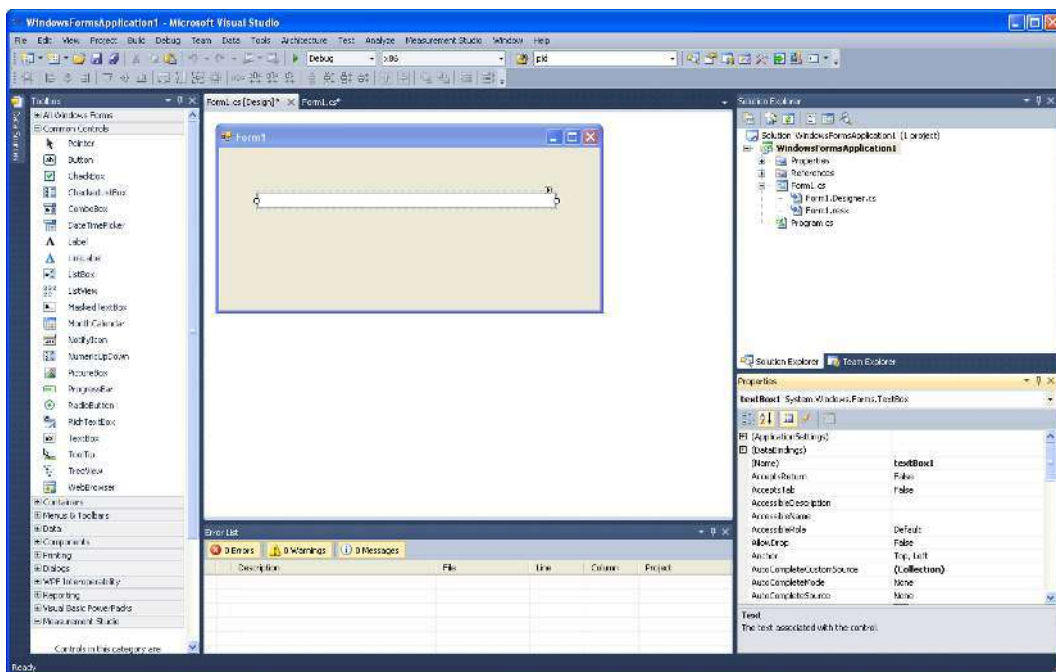

In this project we use a simple TextBox (textBox1) and when we start the program the text “Hello World” is written to the TextBox.

The code is as follows:

```
using System;
using System.Collections.Generic;
using System.ComponentModel;
using System.Data;
using System.Drawing;
using System.Linq;
using System.Text;
using System.Windows.Forms;

namespace WindowsFormsApplication1
{
    public partial class Form1 : Form
    {
        public Form1()
        {
            InitializeComponent();
        }
    }
}
```

```
private void Form1_Load(object sender, EventArgs e)
{
    textBox1.Text = "Hello World";
}
}
```

4. Getting Started with C#

C# is a modern Object-oriented programming language.

Object-oriented programming (OOP) is a programming paradigm using "objects" – data structures consisting of data fields and methods together with their interactions – to design applications and computer programs. Programming techniques may include features such as data abstraction, encapsulation, messaging, modularity, polymorphism, and inheritance.

4.1. Introduction

In this chapter we will start with the basic all programming languages have:...

- Data Types and Variables
- Control Flow: If-Else, etc.
- Loops: While Loops, For Loops, etc.

Further we will introduce the following:

- Namespaces
- Classes
- Data Fields
- Methods
- Properties

In the next chapter we will go more in depth of what Object-oriented programming is and introduce the following important OOP topics:

- Inheritance
- Polymorphism
- Encapsulation

Note! C# is case-sensitive.

4.2. Data Types and Variables

“Variables” are simply storage locations for data. You can place data into them and retrieve their contents as part of a C# expression. The interpretation of the data in a variable is controlled through “Types”.

The C# simple types consist of:

- Boolean type
- Numeric types: Integrals, Floating Point, Decimal
- String type

4.2.1. Boolean type

Boolean types are declared using the keyword “bool”. They have two values: “true” or “false”. In other languages, such as C and C++, boolean conditions can be satisfied where 0 means false and anything else means true. However, in C# the only values that satisfy a boolean condition is true and false, which are official keywords.

Example:

```
bool content = true;
bool noContent = false;
```

4.2.2. Numeric types: Integrals, Floating Point, Decimal

Example:

```
int i=35;
long y=654654;
```

```
float x;
double y;
decimal z;
```

4.2.3. String type

Example:

```
string myString="Hei på deg";
```

Special characters that may be used in strings:

Escape Sequence	Meaning
\'	Single Quote
\"	Double Quote
\\	Backslash
\0	Null, not the same as the C# <i>null</i> value
\a	Bell
\b	Backspace
\f	form Feed
\n	Newline
\r	Carriage Return
\t	Horizontal Tab
\v	Vertical Tab

4.2.4. Arrays

Example:

```
int[] myInts = { 5, 10, 15 };
```

4.3. Control Flow

To be able to control the flow in your program is important in every programming language.

The two most important techniques are:

- The **if** Statement
- The **switch** Statement

4.3.1. The if Statement

The if statement is probably the most used mechanism to control the flow in your application.

An if statement allows you to take different paths of logic, depending on a given condition. When the condition evaluates to a boolean true, a block of code for that true condition will execute. You have the option of a single if statement, multiple else if statements, and an optional else statement.

Example:

```
bool myTest;
```

```
myTest=false;

if (myTest==false)
    MessageBox.Show("Hello");
```

If we have more than one line of code that shall be executed, we need to use braces, e.g.:

```
bool myTest;

myTest=false;

if (myTest == false)
{
    MessageBox.Show("Hello1");
    MessageBox.Show("Hello2");
}
```

For more complex logic we use the **if ... else** statement.

Example:

```
bool myTest;

myTest=true;

if (myTest == false)
{
    MessageBox.Show("Hello1");
}
else
{
    MessageBox.Show("Hello2");
}
```

Or you can use **nested if... else** if sentences.

Example:

```
int myTest;

myTest=2;

if (myTest == 1)
{
    MessageBox.Show("Hello1");
}
else if (myTest == 2)
{
    MessageBox.Show("Hello2");
}
else
{
    MessageBox.Show("Hello3");
}
```

4.3.2. The switch Statement

Another form of selection statement is the **switch** statement, which executes a set of logic depending on the value of a given parameter. The types of the values a switch statement operates on can be booleans, enums, integral types, and strings.

Example:

```
switch (myTest)
{
    case 1:
        MessageBox.Show("Hello1");
        break;

    case 2:
        MessageBox.Show("Hello2");
        break;

    default:
        MessageBox.Show("Hello3");
        break;
}
```

4.4. Loops

In C# we have different kind of loops:

- The while loop
- The do loop
- The for loop
- The foreach loop

4.4.1. The while Loop

A while loop will check a condition and then continues to execute a block of code as long as the condition evaluates to a boolean value of true.

Example:

```
int myInt = 0;

while (myInt < 10)
{
    MessageBox.Show("Inside Loop: " + myInt.ToString());
    myInt++;
}
MessageBox.Show("Outside Loop: " + myInt.ToString());
```

4.4.2. The do Loop

A do loop is similar to the while loop, except that it checks its condition at the end of the loop. This means that the do loop is guaranteed to execute at least one time. On the other hand, a while loop evaluates its boolean expression at the beginning and there is generally no guarantee that the statements inside the loop will be executed, unless you program the code to explicitly do so.

Example:

```
int myInt = 0;

do
{
    MessageBox.Show("Inside Loop: " + myInt.ToString());
    myInt++;
} while (myInt < 10);
MessageBox.Show("Outside Loop: " + myInt.ToString());
```

4.4.3. The for Loop

A for loop works like a while loop, except that the syntax of the for loop includes initialization and condition modification. for loops are appropriate when you know exactly how many times you want to perform the statements within the loop.

Example:

```
for (int i = 0; i < 10; i++)
{
    MessageBox.Show("Inside Loop: " + myInt.ToString());
    myInt++;
}
MessageBox.Show("Outside Loop: " + myInt.ToString());
```

4.4.4. The foreach Loop

A foreach loop is used to iterate through the items in a list. It operates on arrays or collections.

Example:

```
string[] names = { "Elvis", "Beatles", "Eagles", "Rolling Stones" };

foreach (string person in names)
{
    MessageBox.Show(person);
}
```

4.5. Methods

Methods are extremely useful because they allow you to separate your logic into different units. You can pass information to methods, have it perform one or more statements, and retrieve a return value. The capability to pass parameters and return values is optional and depends on what you want the method to do.

Methods are similar to functions, procedure or subroutine used in other programming languages. The difference is that a method is always a part of a class.

Example:

```
public void ShowCarColor(string color)
```



```
{  
    MessageBox.Show("My Car is: " + color);  
}
```

We learn more about methods in the Classes section below.

We have 2 kinds of Methods:

- Static Methods
- Nonstatic Methods (Instance Method)

Static Methods belongs to the whole class, while nonstatic Methods belong to each instance created from the class.

4.5.1. Nonstatic Methods

Example:

We define the class:

```
class Car  
{  
    //Nonstatic/Instance Method  
    public void SetColor(string color)  
    {  
        MessageBox.Show("My Car is: " + color);  
    }  
}
```

Then we use it:

```
Car myCar = new Car(); //We create an Instance of the Class  
myCar.SetColor("blue"); //We call the Method
```

4.5.2. Static Methods

Example:

We define the class:

```
class Boat  
{  
    //Static Method  
    public static void SetColor(string color)  
    {  
        MessageBox.Show("My Boat is: " + color);  
    }  
}
```

Then we use it:

```
Boat.SetColor("green");
```

i.e., we don't need to create an object/instantiating the class before we use the Static Method.

4.6. Namespaces

Namespaces are C# program elements designed to help you organize your programs. They also provide assistance in avoiding name clashes between two sets of code. Implementing Namespaces in your own code is a good habit because it is likely to save you from problems later when you want to reuse some of your code.

You specify the Namespaces you want to use in the top of your code.

Example:

When you create a new Windows Forms application, the following default namespaces will be included.

```
using System;
using System.Collections.Generic;
using System.ComponentModel;
using System.Data;
using System.Drawing;
using System.Linq;
using System.Text;
using System.Windows.Forms;
...
```

It is just to add more when you need it.

More about Namespaces later.

4.7. Classes

The first step in OOP is to identify all the objects you want to manipulate and how they relate to each other, an exercise often known as data modeling. Once you've identified an object, you generalize it as a class of objects and define the kind of data it contains and any logic sequences that can manipulate it. Each distinct logic sequence is known as a method. A real instance of a class is called an "object" or an "instance of a class". The object or class instance is what you run in the computer. Its methods provide computer instructions and the class object characteristics provide relevant data. You communicate with objects - and they communicate with each other.

Everything in C# is based on Classes. Classes are declared by using the keyword `class` followed by the class name and a set of class members surrounded by curly braces.

A class normally consists of Methods, Fields and Properties.

Every class has a constructor, which is called automatically any time an instance of a class is created. The purpose of constructors is to initialize class members when an instance of the class is created. Constructors do not have return values and always have the same name as the class.

Example:

We define the following class:

```
class Car
{
    public string color; //Field

    //Method
    public void ShowCarColor()
    {
        MessageBox.Show("My Car is: " + color);
    }
}
```

Then we can use it:

```
Car myCar = new Car(); //We create an Instance of the Class
myCar.color = "blue"; //We set a value for the color Field
myCar.ShowCarColor(); //We call the Method
```

The result is as follows:



4.7.1. Constructor

The purpose of constructors is to initialize class members when an instance of the class is created.

Example:

We can use a Constructor to create a “default” color for our car.

We define the class:

```
class Car
{
    public string color; //Field

    //Constructor - Used to initialize the Class
    public Car()
    {
        color="green";
    }

    //Method
    public void ShowCarColor()
    {
        MessageBox.Show("My Car is: " + color);
    }
}
```

Then we can use it:

```
Car myCar = new Car(); //We create an Instance of the Class
myCar.ShowCarColor(); //We call the Method
myCar.color = "blue"; //We set a value for the color Field
myCar.ShowCarColor(); //We call the Method
```

The results are as follows:



...



Example:

We can also do the following:

```
class Car
{
    public string color; //Field

    //Constructor - Used to initialize the Class
    public Car(string initColor)
    {
        color = initColor;
    }
}
```

```
    }

    //Method
    public void ShowCarColor()
    {

        MessageBox.Show("My Car is: " + color);

    }
}
```

Then we use it:

```
Car myCar = new Car("green"); //We create an Instance of the Class
myCar.ShowCarColor(); //We call the Method
```

New feature: Initialization an object without a Constructor:

In C# 4.0 we can do the following:

We define the Class (without any constructor):

```
class Car
{

    public string color; //Field
    public string model; //Field

    //Method
    public void ShowCarColor()
    {

        MessageBox.Show("My Car Color is: " + color);
        MessageBox.Show("My Car Model is: " + model);

    }
}
```

Then we do the following:

```
Car myCar = new Car {color="white", model="2004"};
myCar.ShowCarColor(); //We call the Method
```

4.8. Properties

Properties provide the opportunity to protect a field in a class by reading and writing to it through the property. In other languages, this is often accomplished by programs implementing specialized getter and setter methods. C# properties enable this type of protection while also letting you access the property just like it was a field.

Example:

We define a Class with Properties and a Method:

```
class Car
{
```

```
public string Name {get; set;}
public string Color {get; set;}

public void ShowCarProperties()
{
    MessageBox.Show("My Car Name is: " + Name);
    MessageBox.Show("My Car Color is: " + Color);
}
}
```

Then we can use it:

```
Car myCar = new Car();
myCar.Name="Volvo";
myCar.Color="Blue";

myCar.ShowCarProperties();
```

The results are:

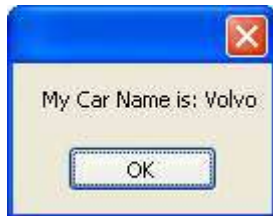

...



So far, the only class members you've seen are Fields, Properties, Methods, and Constructors. Here is a complete list of the types of members you can have in your classes:

- **Constructors**
- Destructors (opposite of Constructors)
- **Fields**
- **Methods**
- **Properties**
- Indexers
- Delegates
- **Events**
- Nested Classes

4.9. Naming Convention

There is different name convention for how to specify your variables, classes and Methods, etc.

Camel notation:

For **variables** and **parameters/arguments** we normally use “Camel notation”.

Examples:

```
string myCar;  
int number;  
string backColor;
```

→ In Camel casing the first letter of an identifier is lowercase and the first letter of each subsequent concatenated word is capitalized.

Pascal notation:

For **classes**, **methods** and **properties**, we normally use “Pascal notation”.

Examples:

```
class Car  
{  
    void ShowCarColor()  
    {  
        ...  
    }  
}
```

→ In Pascal casing the first letter in the identifier and the first letter of each subsequent concatenated word are capitalized.

For Namespaces we use Pascal casing and a dot separator.

Examples:

```
System.Drawing  
System.Collections.Generic
```

Controls:

For controls on your user interface we either use “Pascal notation” or “Hungarian notation”, but stick to one of them!

Examples:

“Pascal notation”:

```
LoginName  
LoginPassword
```

“Hungarian notation”:

```
txtName  
txtPassword  
lblName  
btnCancel
```

Where “txt” means it is a Text Control, “lbl” a Label Control, “btn” a Button Control, etc.

Acronyms:

Casing of acronyms depends on the length of the acronym. All acronyms are at least two characters long. If an acronym is exactly two characters, it is considered a short acronym. An acronym of three or more characters is a long acronym.

In general, you should not use abbreviations or acronyms. These make your names less readable. Similarly, it is difficult to know when it is safe to assume that an acronym is widely recognized.

But if you must, the rules are as follows:

Short acronym Examples (two characters):

```
DBRate
```

A property named DBRate is an example of a short acronym (DB) used as the first word of a Pascal-cased identifier.

```
ioChannel
```

A parameter named ioChannel is an example of a short acronym (IO) used as the first word of a camel-cased identifier.

Long acronym Examples (three or more characters):

```
XmlWriter
```

A class named XmlWriter is an example of a long acronym used as the first word of a Pascal-cased identifier.

```
htmlReader
```

A parameter named htmlReader is an example of a long acronym used as the first word of a camel-cased identifier.

5. More Object-oriented Techniques

In this chapter we will introduce the following Object-oriented techniques:

- Inheritance
- Polymorphism
- Encapsulation

5.1. Inheritance

Inheritance is one of the primary concepts of object-oriented programming. It allows you to reuse existing code. Through effective employment of reuse, you can save time in your programming.

Example:

We define the Base class:

```
class Car
{
    public void SetColor(string color)
    {
        MessageBox.Show("My Car is: " + color);
    }
}
```

Then we define a new class that inherits from the Base Class:

```
class Volvo : Car
{
    //In this simple Example this class does nothing!
}
```

Then we start using the classes:

```
Car myCar = new Car();
myCar.SetColor("blue");

Volvo myVolvo = new Volvo();
```

```
myVolvo.SetColor("green");
```

As you can see we can use the "SetColor()" Method that has been defined in the Base Class.

5.2. Polymorphism

Another primary concept of object-oriented programming is Polymorphism. It allows you to invoke derived class methods through a base class reference during run-time.

Example:

We start with a Base Class:

```
class Car
{
    public virtual void CarType()
    {
        MessageBox.Show("I am a Car");
    }
}
```

The virtual modifier indicates to derived classes that they can override this method.

Then we create 3 new Classes that derive from the Base Class:

```
class Volvo : Car
{
    public override void CarType()
    {
        MessageBox.Show("I am a Volvo");
    }
}

class Ford : Car
{
    public override void CarType()
    {
        MessageBox.Show("I am a Ford");
    }
}

class Toyota : Car
{
    public override void CarType()
    {
        MessageBox.Show("I am a Toyota");
    }
}
```

These 3 classes inherit the Car class. Each class has a CarType() method and each CarType() method has an override modifier. The override modifier allows a method to override the virtual method of its base class at run-time.

Then we can use it:

```
Car[] car = new Car[4];
car[0] = new Car();
```

```

car[1] = new Volvo();
car[2] = new Ford();
car[3] = new Toyota();

foreach (Car carmodel in car)
{
    carmodel.CarType();
}

```

The result is:

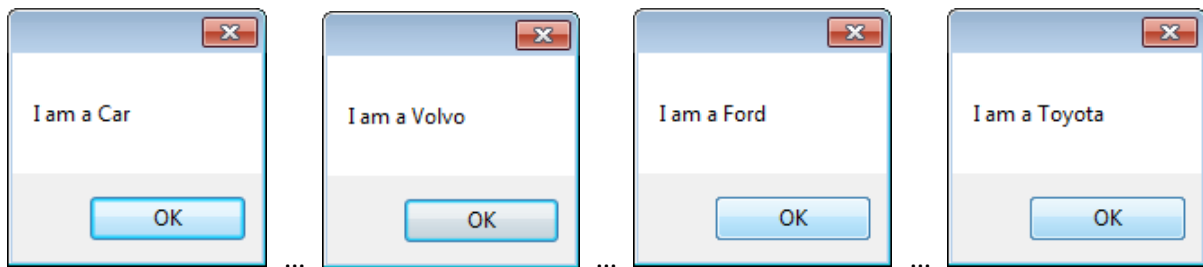

→ This is Polymorphism.

5.3. Encapsulation

Encapsulation means that the internal representation of an object is generally hidden from view outside of the object's definition. Typically, only the object's own methods can directly inspect or manipulate its fields.

We can set different Access rights on Classes and Methods:

Access Modifier	Description (who can access)
private	Only members within the same type. (default for type members)
protected	Only derived types or members of the same type.
internal	Only code within the same assembly. Can also be code external to object as long as it is in the same assembly. (default for types)
protected internal	Either code from derived type or code in the same assembly. Combination of protected OR internal.
public	Any code. No inheritance, external type, or external assembly restrictions.

6. Exception Handling

In programming error and exception handling is very important. C# has built-in and ready to use mechanism to handle this. This mechanism is based on the keywords *try*, *catch*, *throw* and *finally*.

Exceptions are unforeseen errors that happen in your programs. Most of the time, you can, and should, detect and handle program errors in your code. For example, validating user input, checking for null objects, and verifying the values returned from methods are what you expect, are all examples of good standard error handling that you should be doing all the time.

However, there are times when you don't know if an error will occur. For example, you can't predict when you'll receive a file I/O error, run out of system memory, or encounter a database error. These things are generally unlikely, but they could still happen and you want to be able to deal with them when they do occur. This is where exception handling comes in.

When exceptions occur, they are said to be “thrown”. C# uses the keywords *try*, *catch*, *throw* and *finally*. It works like this: A method will try to execute a piece of code. If the code detects a problem, it will *throw* an error indication, which your code can *catch*, and no matter what happens, it *finally* executes a special code block at the end.

The syntax is as follows:

```
MyMethod()
{
    try
    {
        ... //Do Something that can cause an Exception
    }
    catch
    {
        ... //Handle Exceptions
    }

    finally
    {
        ... //Clean Up
    }
}
```

Example:

```
public void WriteDaqData(double analogDataOut)
{
    Task analogOutTask = new Task();
```

```
AOChannel myAOChannel;

try
{
    myAOChannel = analogOutTask.AOChannels.CreateVoltageChannel(
        aoChannel,
        "myAOChannel",
        0,
        5,
        AOVoltageUnits.Volts
    );

    AnalogSingleChannelWriter writer = new
        AnalogSingleChannelWriter(analogOutTask.Stream);

    writer.WriteSingleSample(true, analogDataOut);
}
catch (Exception e)
{
    string errorMessage;

    errorMessage = e.Message.ToString();
}

finally
{
    analogOutTask.Stop();
}
}
```

7. Windows Forms Example

In this chapter we will go through a large example. In this example we will create an application in Visual Studio that controls the following water tank process:

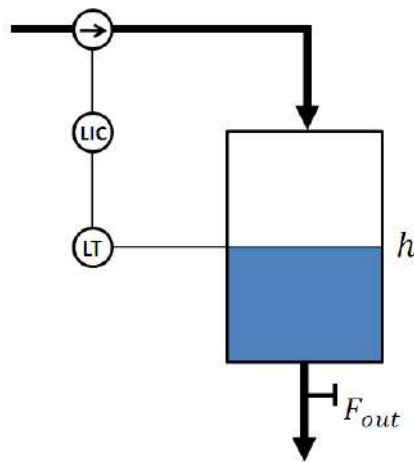

The purpose is to control the level in the water tank. In order to communicate with the physical process we use a NI USB-6008 DAQ device:



We will not show all the details in the code, but focus on the structure.

Below we see the user interface we have created in Visual Studio:

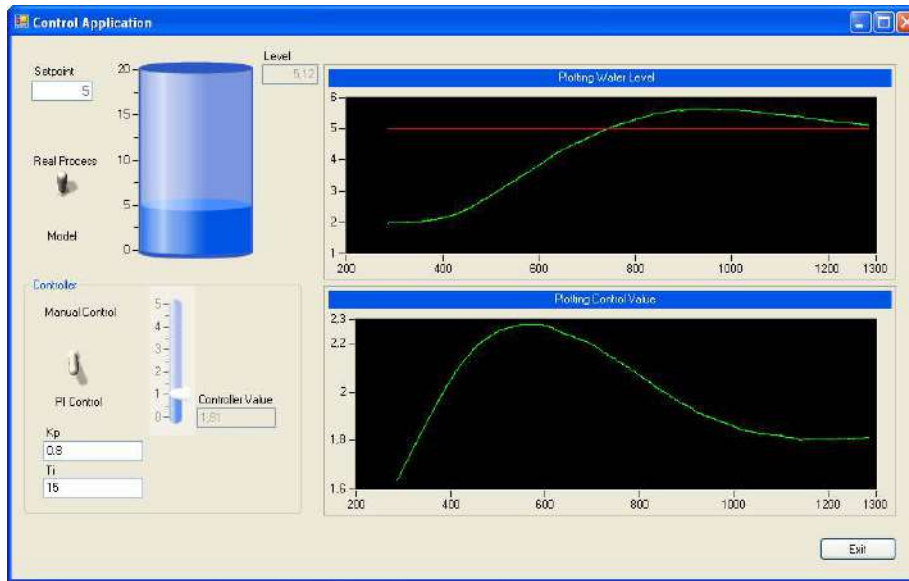

Below we see the Visual Studio project:

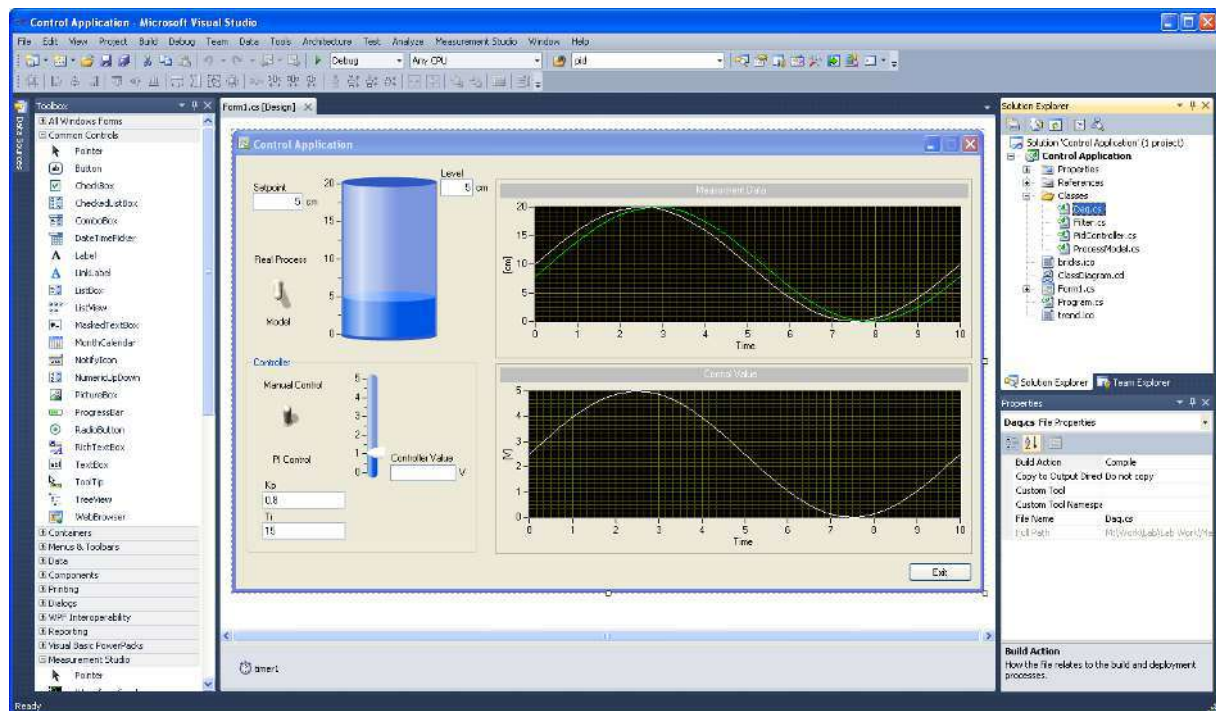

We start with defining the classes we need in our application.

In the Solution Explorer we have defined a “Classes” folder where we put all the classes we create:

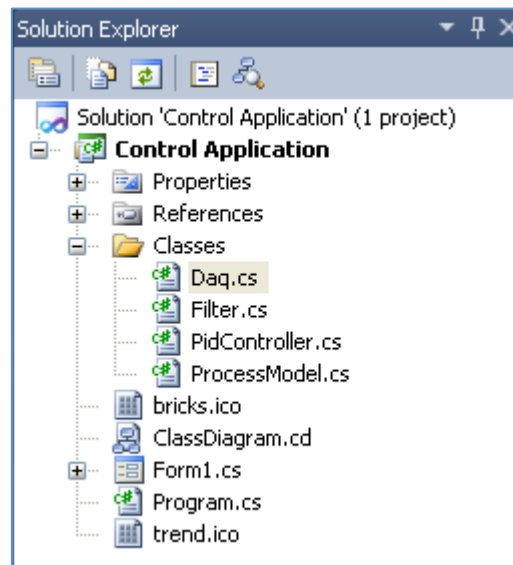

In order to create new classes we right-click in the Solution Explorer and select “Add-New Item...”:

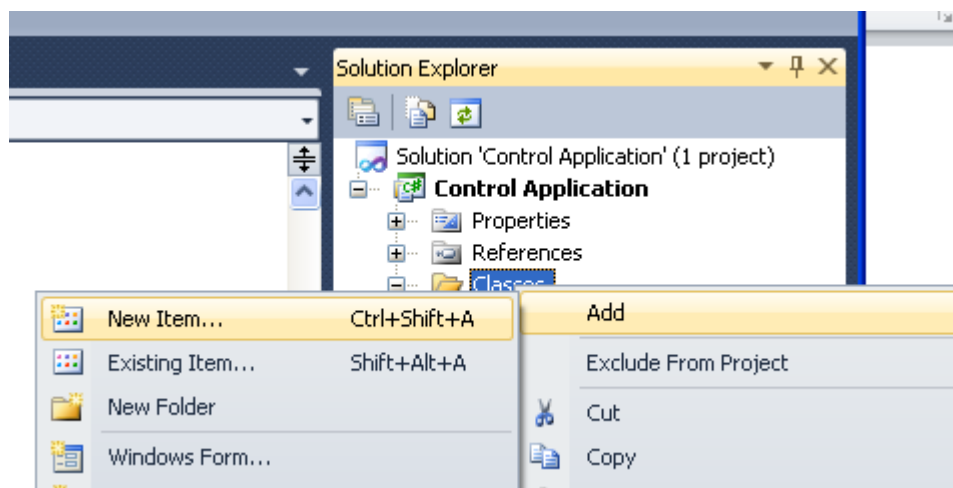

Next we select the **Class** item in the “Add New Item” window:

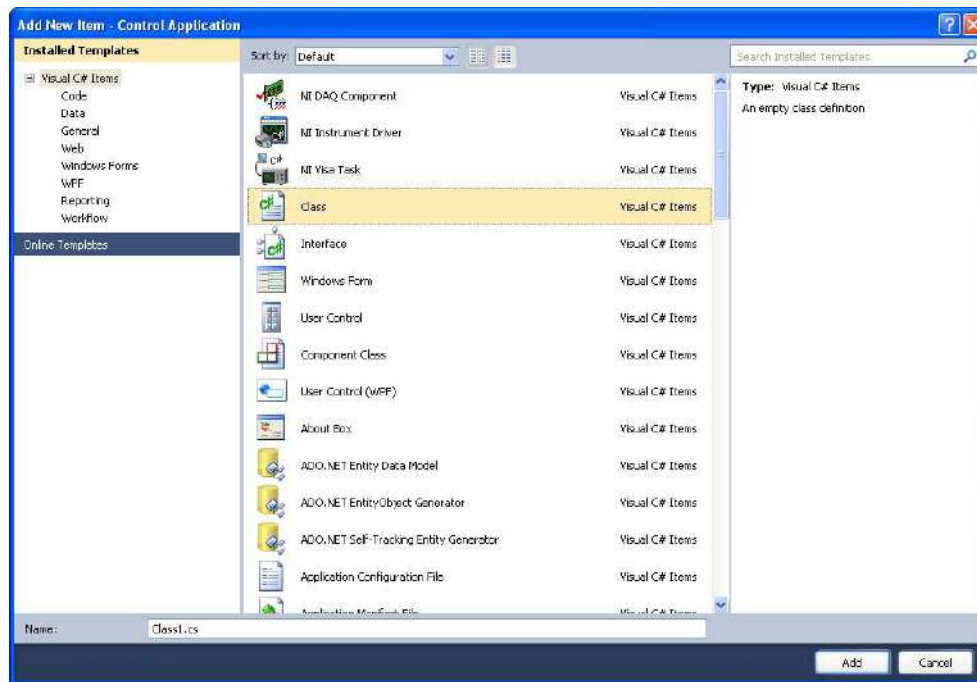

Classes:

We start with the “Daq” Class that contains logic for reading and writing to the DAQ device:

```
//Include necessary Namespaces
using System;
using System.Collections.Generic;
using System.Linq;
using System.Text;
using NationalInstruments;
using NationalInstruments.DAQmx;

namespace Tuc.Control //We define a useful namespace
{
    public class DaqData
    {
        public string aiChannel;
        public string aoChannel;

        //Constructor
        public DaqData(...)
        {
            ...
        }

        //Method
        public double ReadDaqData()
        {
            ...
        }

        //Method
        public void WriteDaqData(...)
        {
            ...
        }
    }
}
```

It is good practice to create a new file for each new class we define. Then we start by defining a meaningful Namespace. Next we define our Class with necessary Fields, Properties and Methods.

We also need to include the necessary Namespace our Class will need. In this example we have included some 3.party Assemblies from National Instruments:

```
using NationalInstruments;  
using NationalInstruments.DAQmx;
```

These Assemblies contains the driver to the NI USB-6008 DAQ device we are using.

The Assemblies we use must be added in the “References” folder in the Solution Explorer:

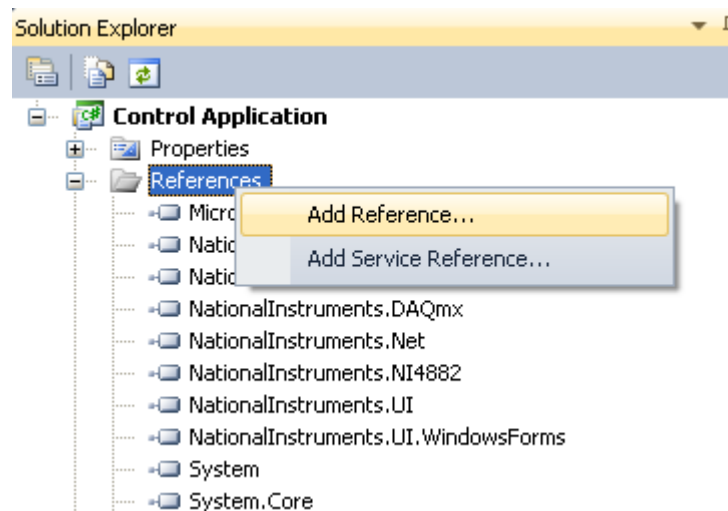

Main Application:

In our main application we start with including our Namespace:

```
using NationalInstruments;  
using NationalInstruments.UI;  
using NationalInstruments.UI.WindowsForms;  
using System;  
using System.Collections.Generic;  
using System.ComponentModel;  
using System.Data;  
using System.Drawing;  
using System.Linq;  
using System.Text;  
using System.Windows.Forms;  
using Tuc.Control;  
  
namespace Control_Application  
{  
    public partial class Form1 : Form  
    {  
        ...  
    }  
}
```

It is also a good idea to create different regions in order to structure your code better. This can be done like this:

```
//Comment  
# region  
    ... //Your Code  
# endregion
```

In this way our Main Application may look like this:

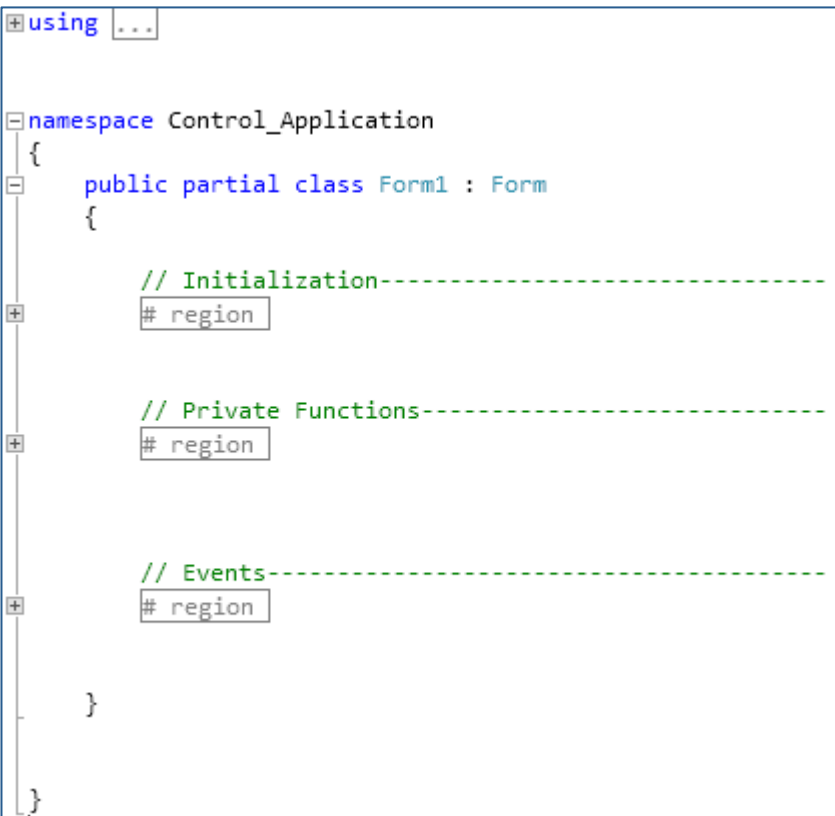

```
+ using ...  
  
- namespace Control_Application  
  {  
  - public partial class Form1 : Form  
    {  
    + // Initialization-----  
      # region  
    +  
    + // Private Functions-----  
      # region  
    +  
    + // Events-----  
      # region  
    }  
  }  
}
```

8. Web Programming

8.1. Introduction

Today most of the applications focus on the Internet, where the applications can be viewed in a standard Web Browser. Static Web pages are based on HTML and CSS. In order to create more advanced applications, we need more powerful tools.

Important frameworks and tools for creating dynamic web pages:

- ASP.NET
- AJAX/ ASP.NET AJAX
- JavaScript
- Silverlight

These frameworks and tools will be explained below.

See the Tutorial “ASP.NET and Web Programming” for more details.

8.2. HTML

HTML, which stands for HyperText Markup Language, is the predominant markup language for web pages. HTML is the basic building-blocks of webpages.

HTML is written in the form of HTML elements consisting of tags, enclosed in angle brackets (like <html>), within the web page content. HTML tags normally come in pairs like <h1> and </h1>. The first tag in a pair is the start tag, the second tag is the end tag (they are also called opening tags and closing tags). In between these tags web designers can add text, tables, images, etc.

8.3. Web Browser

The purpose of a web browser is to read HTML documents and compose them into visual or audible web pages. The browser does not display the HTML tags, but uses the tags to interpret the content of the page.

Today we have the following major Web Browsers:

- Internet Explorer (by Microsoft)
- Firefox (by Mozilla)
- Chrome (by Google)
- Safari (by Apple)
- Opera (by Opera from Norway)

8.4. CSS

Web browsers can also refer to Cascading Style Sheets (CSS) to define the appearance and layout of text and other material.

The W3C, maintainer of both the HTML and the CSS standards

8.5. JavaScript

JavaScript is an object-oriented scripting language basically used to create dynamic web pages. JavaScript is primarily used in the form of client-side JavaScript, implemented as part of a web browser in order to provide enhanced user interfaces and dynamic websites.

8.6. ASP.NET

ASP.NET is a web application framework developed by Microsoft to allow programmers to build dynamic web sites, web applications and web services.

ASP.NET is part of the Visual Studio package

It was first released in January 2002 with version 1.0 of the .NET Framework, and is the successor to Microsoft's Active Server Pages (ASP) technology. ASP.NET is built on the Common Language Runtime (CLR), allowing programmers to write ASP.NET code using any supported .NET language, such as C# and VB.NET.

ASP.NET web pages or webpage, known officially as Web Forms], are the main building block for application development. Web forms are contained in files with an “.aspx” extension.

Select “ASP.NET Application” in the “New Project” window:

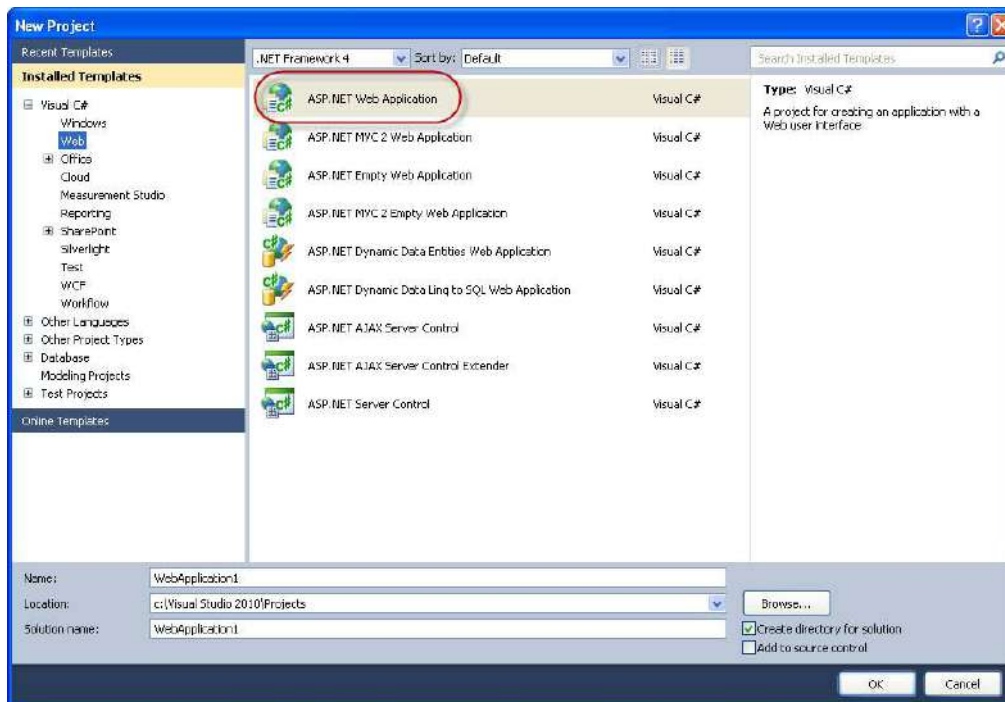

8.7. AJAX/ ASP.NET AJAX

AJAX is an acronym for Asynchronous JavaScript and XML. AJAX is a group of interrelated web development methods used on the client-side to create interactive web applications. With Ajax, web applications can send data to, and retrieve data from, a server asynchronously (in the background) without interfering with the display and behavior of the existing page.

ASP.NET AJAX is a set of extensions to ASP.NET developed by Microsoft for implementing AJAX functionality.

8.8. Silverlight

Microsoft Silverlight is an application framework for writing and running browser plug-ins or other rich internet applications, with features and purposes similar to those of Adobe Flash. The run-time environment for Silverlight is available as a plug-in for most web browsers. Silverlight is also one of the two application development platforms for Windows Phone 7/8.

The latest version is Silverlight 5.0.

Silverlight is based on WPF, so in Silverlight applications, user interfaces are declared in Extensible Application Markup Language (XAML) and programmed using a subset of the .NET Framework.

9. Database Programming

Most of today's applications use a backend database to store important data, e.g., Facebook, Twitter, etc.

In order to use databases in our applications we need to know **Structured Query language (SQL)**. For more information about SQL, see the following Tutorial:

[Structured Query Language \(SQL\)](#)

In addition you need to know about database systems. We have different kind of database systems and lots of different vendors. Since this Tutorial is about Visual Studio and C#, we will use **Microsoft SQL Server**. For more information about database systems in general and specially SQL Server, see the following Tutorial:

[Introduction to Database Systems](#)

The Tutorials are available from: <http://home.hit.no/~hansha>

9.1. ADO.NET

ADO.NET (ActiveX Data Object for .NET) is a set of computer software components that programmers can use to access data and data services. It is a part of the base class library that is included with the Microsoft .NET Framework. It is commonly used by programmers to access and modify data stored in relational database systems, though it can also access data in non-relational sources.



Høgskolen i Telemark

Telemark University College

Faculty of Technology

Kjølnes Ring 56

N-3914 Porsgrunn, Norway

www.hit.no

Hans-Petter Halvorsen, M.Sc.

Telemark University College

Faculty of Technology

Department of Electrical Engineering, Information Technology and Cybernetics

E-mail: hans.p.halvorsen@hit.no

Blog: <http://home.hit.no/~hansha/>

