

# INTRODUCTION TO REAL ANALYSIS

**William F. Trench**

Andrew G. Cowles Distinguished Professor Emeritus  
Department of Mathematics  
Trinity University  
San Antonio, Texas, USA  
[wtrench@trinity.edu](mailto:wtrench@trinity.edu)

This book has been judged to meet the evaluation criteria set by the Editorial Board of the American Institute of Mathematics in connection with the Institute's [Open Textbook Initiative](#). It may be copied, modified, redistributed, translated, and built upon subject to the Creative Commons

[Attribution-NonCommercial-ShareAlike 3.0 Unported License](#).

**FREE DOWNLOADABLE SUPPLEMENTS**

**[FUNCTIONS DEFINED BY IMPROPER INTEGRALS](#)**

**[THE METHOD OF LAGRANGE MULTIPLIERS](#)**

*Library of Congress Cataloging-in-Publication Data*

Trench, William F.

Introduction to real analysis / William F. Trench

p. cm.

ISBN 0-13-045786-8

1. Mathematical Analysis. I. Title.

QA300.T667 2003

515-dc21

2002032369

Free Hyperlinked Edition 2.04 December 2013

This book was published previously by Pearson Education.

This free edition is made available in the hope that it will be useful as a textbook or reference. Reproduction is permitted for any valid noncommercial educational, mathematical, or scientific purpose. However, charges for profit beyond reasonable printing costs are prohibited.

A complete instructor's solution manual is available by email to [wtrench@trinity.edu](mailto:wtrench@trinity.edu), subject to verification of the requestor's faculty status. Although this book is subject to a Creative Commons license, the solutions manual is not. The author reserves all rights to the manual.

**TO BEVERLY**

# Contents

Preface	vi
<b>Chapter 1 The Real Numbers</b>	<b>1</b>
1.1 The Real Number System	1
1.2 Mathematical Induction	10
1.3 The Real Line	19
<b>Chapter 2 Differential Calculus of Functions of One Variable</b>	<b>30</b>
2.1 Functions and Limits	30
2.2 Continuity	53
2.3 Differentiable Functions of One Variable	73
2.4 L'Hospital's Rule	88
2.5 Taylor's Theorem	98
<b>Chapter 3 Integral Calculus of Functions of One Variable</b>	<b>113</b>
3.1 Definition of the Integral	113
3.2 Existence of the Integral	128
3.3 Properties of the Integral	135
3.4 Improper Integrals	151
3.5 A More Advanced Look at the Existence of the Proper Riemann Integral	171
<b>Chapter 4 Infinite Sequences and Series</b>	<b>178</b>
4.1 Sequences of Real Numbers	179
4.2 Earlier Topics Revisited With Sequences	195
4.3 Infinite Series of Constants	200

4.4 Sequences and Series of Functions	234
4.5 Power Series	257
Chapter 5 Real-Valued Functions of Several Variables	281
5.1 Structure of $\mathbb{R}^n$	281
5.2 Continuous Real-Valued Function of $n$ Variables	302
5.3 Partial Derivatives and the Differential	316
5.4 The Chain Rule and Taylor's Theorem	339
Chapter 6 Vector-Valued Functions of Several Variables	361
6.1 Linear Transformations and Matrices	361
6.2 Continuity and Differentiability of Transformations	378
6.3 The Inverse Function Theorem	394
6.4. The Implicit Function Theorem	417
Chapter 7 Integrals of Functions of Several Variables	435
7.1 Definition and Existence of the Multiple Integral	435
7.2 Iterated Integrals and Multiple Integrals	462
7.3 Change of Variables in Multiple Integrals	484
Chapter 8 Metric Spaces	518
8.1 Introduction to Metric Spaces	518
8.2 Compact Sets in a Metric Space	535
8.3 Continuous Functions on Metric Spaces	543
Answers to Selected Exercises	549
Index	563

# Preface

This is a text for a two-term course in introductory real analysis for junior or senior mathematics majors and science students with a serious interest in mathematics. Prospective educators or mathematically gifted high school students can also benefit from the mathematical maturity that can be gained from an introductory real analysis course.

The book is designed to fill the gaps left in the development of calculus as it is usually presented in an elementary course, and to provide the background required for insight into more advanced courses in pure and applied mathematics. The standard elementary calculus sequence is the only specific prerequisite for Chapters 1–5, which deal with real-valued functions. (However, other analysis oriented courses, such as elementary differential equation, also provide useful preparatory experience.) Chapters 6 and 7 require a working knowledge of determinants, matrices and linear transformations, typically available from a first course in linear algebra. Chapter 8 is accessible after completion of Chapters 1–5.

Without taking a position for or against the current reforms in mathematics teaching, I think it is fair to say that the transition from elementary courses such as calculus, linear algebra, and differential equations to a rigorous real analysis course is a bigger step today than it was just a few years ago. To make this step today's students need more help than their predecessors did, and must be coached and encouraged more. Therefore, while striving throughout to maintain a high level of rigor, I have tried to write as clearly and informally as possible. In this connection I find it useful to address the student in the second person. I have included 295 completely worked out examples to illustrate and clarify all major theorems and definitions.

I have emphasized careful statements of definitions and theorems and have tried to be complete and detailed in proofs, except for omissions left to exercises. I give a thorough treatment of real-valued functions before considering vector-valued functions. In making the transition from one to several variables and from real-valued to vector-valued functions, I have left to the student some proofs that are essentially repetitions of earlier theorems. I believe that working through the details of straightforward generalizations of more elementary results is good practice for the student.

Great care has gone into the preparation of the 761 numbered exercises, many with multiple parts. They range from routine to very difficult. Hints are provided for the more difficult parts of the exercises.

## Organization

Chapter 1 is concerned with the real number system. Section 1.1 begins with a brief discussion of the axioms for a complete ordered field, but no attempt is made to develop the reals from them; rather, it is assumed that the student is familiar with the consequences of these axioms, except for one: completeness. Since the difference between a rigorous and nonrigorous treatment of calculus can be described largely in terms of the attitude taken toward completeness, I have devoted considerable effort to developing its consequences. Section 1.2 is about induction. Although this may seem out of place in a real analysis course, I have found that the typical beginning real analysis student simply cannot do an induction proof without reviewing the method. Section 1.3 is devoted to elementary set theory and the topology of the real line, ending with the Heine-Borel and Bolzano-Weierstrass theorems.

Chapter 2 covers the differential calculus of functions of one variable: limits, continuity, differentiability, L'Hospital's rule, and Taylor's theorem. The emphasis is on rigorous presentation of principles; no attempt is made to develop the properties of specific elementary functions. Even though this may not be done rigorously in most contemporary calculus courses, I believe that the student's time is better spent on principles rather than on reestablishing familiar formulas and relationships.

Chapter 3 is devoted to the Riemann integral of functions of one variable. In Section 3.1 the integral is defined in the standard way in terms of Riemann sums. Upper and lower integrals are also defined there and used in Section 3.2 to study the existence of the integral. Section 3.3 is devoted to properties of the integral. Improper integrals are studied in Section 3.4. I believe that my treatment of improper integrals is more detailed than in most comparable textbooks. A more advanced look at the existence of the proper Riemann integral is given in Section 3.5, which concludes with Lebesgue's existence criterion. This section can be omitted without compromising the student's preparedness for subsequent sections.

Chapter 4 treats sequences and series. Sequences of constant are discussed in Section 4.1. I have chosen to make the concepts of limit inferior and limit superior parts of this development, mainly because this permits greater flexibility and generality, with little extra effort, in the study of infinite series. Section 4.2 provides a brief introduction to the way in which continuity and differentiability can be studied by means of sequences. Sections 4.3–4.5 treat infinite series of constant, sequences and infinite series of functions, and power series, again in greater detail than in most comparable textbooks. The instructor who chooses not to cover these sections completely can omit the less standard topics without loss in subsequent sections.

Chapter 5 is devoted to real-valued functions of several variables. It begins with a discussion of the topology of  $\mathbb{R}^n$  in Section 5.1. Continuity and differentiability are discussed in Sections 5.2 and 5.3. The chain rule and Taylor's theorem are discussed in Section 5.4.

Chapter 6 covers the differential calculus of vector-valued functions of several variables. Section 6.1 reviews matrices, determinants, and linear transformations, which are integral parts of the differential calculus as presented here. In Section 6.2 the differential of a vector-valued function is defined as a linear transformation, and the chain rule is discussed in terms of composition of such functions. The inverse function theorem is the subject of Section 6.3, where the notion of branches of an inverse is introduced. In Section 6.4 the implicit function theorem is motivated by first considering linear transformations and then stated and proved in general.

Chapter 7 covers the integral calculus of real-valued functions of several variables. Multiple integrals are defined in Section 7.1, first over rectangular parallelepipeds and then over more general sets. The discussion deals with the multiple integral of a function whose discontinuities form a set of Jordan content zero. Section 7.2 deals with the evaluation by iterated integrals. Section 7.3 begins with the definition of Jordan measurability, followed by a derivation of the rule for change of content under a linear transformation, an intuitive formulation of the rule for change of variables in multiple integrals, and finally a careful statement and proof of the rule. The proof is complicated, but this is unavoidable.

Chapter 8 deals with metric spaces. The concept and properties of a metric space are introduced in Section 8.1. Section 8.2 discusses compactness in a metric space, and Section 8.3 discusses continuous functions on metric spaces.

Corrections—mathematical and typographical—are welcome and will be incorporated when received.

William F. Trench  
wtrench@trinity.edu  
Home: 659 Hopkinton Road  
Hopkinton, NH 03229



# CHAPTER 1

## The Real Numbers

IN THIS CHAPTER we begin the study of the real number system. The concepts discussed here will be used throughout the book.

SECTION 1.1 deals with the axioms that define the real numbers, definitions based on them, and some basic properties that follow from them.

SECTION 1.2 emphasizes the principle of mathematical induction.

SECTION 1.3 introduces basic ideas of set theory in the context of sets of real numbers. In this section we prove two fundamental theorems: the Heine–Borel and Bolzano–Weierstrass theorems.

### 1.1 THE REAL NUMBER SYSTEM

Having taken calculus, you know a lot about the real number system; however, you probably do not know that all its properties follow from a few basic ones. Although we will not carry out the development of the real number system from these basic properties, it is useful to state them as a starting point for the study of real analysis and also to focus on one property, completeness, that is probably new to you.

#### Field Properties

The real number system (which we will often call simply the *reals*) is first of all a set  $\{a, b, c, \dots\}$  on which the operations of addition and multiplication are defined so that every pair of real numbers has a unique sum and product, both real numbers, with the following properties.

- (A)  $a + b = b + a$  and  $ab = ba$  (commutative laws).
- (B)  $(a + b) + c = a + (b + c)$  and  $(ab)c = a(bc)$  (associative laws).
- (C)  $a(b + c) = ab + ac$  (distributive law).
- (D) There are distinct real numbers 0 and 1 such that  $a + 0 = a$  and  $a1 = a$  for all  $a$ .
- (E) For each  $a$  there is a real number  $-a$  such that  $a + (-a) = 0$ , and if  $a \neq 0$ , there is a real number  $1/a$  such that  $a(1/a) = 1$ .

## 2 Chapter 1 The Real Numbers

The manipulative properties of the real numbers, such as the relations

$$\begin{aligned}(a + b)^2 &= a^2 + 2ab + b^2, \\ (3a + 2b)(4c + 2d) &= 12ac + 6ad + 8bc + 4bd, \\ (-a) &= (-1)a, \quad a(-b) = (-a)b = -ab,\end{aligned}$$

and

$$\frac{a}{b} + \frac{c}{d} = \frac{ad + bc}{bd} \quad (b, d \neq 0),$$

all follow from **(A)**–**(E)**. We assume that you are familiar with these properties.

A set on which two operations are defined so as to have properties **(A)**–**(E)** is called a *field*. The real number system is by no means the only field. The *rational numbers* (which are the real numbers that can be written as  $r = p/q$ , where  $p$  and  $q$  are integers and  $q \neq 0$ ) also form a field under addition and multiplication. The simplest possible field consists of two elements, which we denote by 0 and 1, with addition defined by

$$0 + 0 = 1 + 1 = 0, \quad 1 + 0 = 0 + 1 = 1, \quad (1.1.1)$$

and multiplication defined by

$$0 \cdot 0 = 0 \cdot 1 = 1 \cdot 0 = 0, \quad 1 \cdot 1 = 1 \quad (1.1.2)$$

(Exercise 1.1.2).

### The Order Relation

The real number system is ordered by the relation  $<$ , which has the following properties.

**(F)** For each pair of real numbers  $a$  and  $b$ , exactly one of the following is true:

$$a = b, \quad a < b, \quad \text{or} \quad b < a.$$

**(G)** If  $a < b$  and  $b < c$ , then  $a < c$ . (The relation  $<$  is *transitive*.)

**(H)** If  $a < b$ , then  $a + c < b + c$  for any  $c$ , and if  $0 < c$ , then  $ac < bc$ .

A field with an order relation satisfying **(F)**–**(H)** is an *ordered field*. Thus, the real numbers form an ordered field. The rational numbers also form an ordered field, but it is impossible to define an order on the field with two elements defined by (1.1.1) and (1.1.2) so as to make it into an ordered field (Exercise 1.1.2).

We assume that you are familiar with other standard notation connected with the order relation: thus,  $a > b$  means that  $b < a$ ;  $a \geq b$  means that either  $a = b$  or  $a > b$ ;  $a \leq b$  means that either  $a = b$  or  $a < b$ ; the *absolute value of  $a$* , denoted by  $|a|$ , equals  $a$  if  $a \geq 0$  or  $-a$  if  $a \leq 0$ . (Sometimes we call  $|a|$  the *magnitude of  $a$* .)

You probably know the following theorem from calculus, but we include the proof for your convenience.

**Theorem 1.1.1 (The Triangle Inequality)** *If  $a$  and  $b$  are any two real numbers, then*

$$|a + b| \leq |a| + |b|. \quad (1.1.3)$$

**Proof** There are four possibilities:

- (a) If  $a \geq 0$  and  $b \geq 0$ , then  $a + b \geq 0$ , so  $|a + b| = a + b = |a| + |b|$ .
- (b) If  $a \leq 0$  and  $b \leq 0$ , then  $a + b \leq 0$ , so  $|a + b| = -a + (-b) = |a| + |b|$ .
- (c) If  $a \geq 0$  and  $b \leq 0$ , then  $a + b = |a| - |b|$ .
- (d) If  $a \leq 0$  and  $b \geq 0$ , then  $a + b = -|a| + |b|$ .

Eq. 1.1.3 holds in cases (c) and (d), since

$$|a + b| = \begin{cases} |a| - |b| & \text{if } |a| \geq |b|, \\ |b| - |a| & \text{if } |b| \geq |a|. \end{cases} \quad \blacksquare$$

The triangle inequality appears in various forms in many contexts. It is the most important inequality in mathematics. We will use it often.

**Corollary 1.1.2** *If  $a$  and  $b$  are any two real numbers, then*

$$|a - b| \geq ||a| - |b|| \quad (1.1.4)$$

and

$$|a + b| \geq ||a| - |b||. \quad (1.1.5)$$

**Proof** Replacing  $a$  by  $a - b$  in (1.1.3) yields

$$|a| \leq |a - b| + |b|,$$

so

$$|a - b| \geq |a| - |b|. \quad (1.1.6)$$

Interchanging  $a$  and  $b$  here yields

$$|b - a| \geq |b| - |a|,$$

which is equivalent to

$$|a - b| \geq |b| - |a|, \quad (1.1.7)$$

since  $|b - a| = |a - b|$ . Since

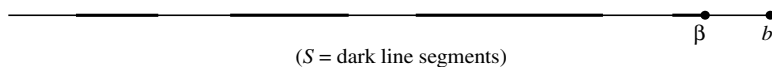
$$||a| - |b|| = \begin{cases} |a| - |b| & \text{if } |a| > |b|, \\ |b| - |a| & \text{if } |b| > |a|, \end{cases}$$

(1.1.6) and (1.1.7) imply (1.1.4). Replacing  $b$  by  $-b$  in (1.1.4) yields (1.1.5), since  $|-b| = |b|$ . ■ **Supremum of a Set**

A set  $S$  of real numbers is *bounded above* if there is a real number  $b$  such that  $x \leq b$  whenever  $x \in S$ . In this case,  $b$  is an *upper bound* of  $S$ . If  $b$  is an upper bound of  $S$ , then so is any larger number, because of property (G). If  $\beta$  is an upper bound of  $S$ , but no number less than  $\beta$  is, then  $\beta$  is a *supremum* of  $S$ , and we write

$$\beta = \sup S.$$

With the real numbers associated in the usual way with the points on a line, these definitions can be interpreted geometrically as follows:  $b$  is an upper bound of  $S$  if no point of  $S$  is to the right of  $b$ ;  $\beta = \sup S$  if no point of  $S$  is to the right of  $\beta$ , but there is at least one point of  $S$  to the right of any number less than  $\beta$  (Figure 1.1.1).



**Figure 1.1.1**

**Example 1.1.1** If  $S$  is the set of negative numbers, then any nonnegative number is an upper bound of  $S$ , and  $\sup S = 0$ . If  $S_1$  is the set of negative integers, then any number  $a$  such that  $a \geq -1$  is an upper bound of  $S_1$ , and  $\sup S_1 = -1$ . ■

This example shows that a supremum of a set may or may not be in the set, since  $S_1$  contains its supremum, but  $S$  does not.

A *nonempty* set is a set that has at least one member. The *empty set*, denoted by  $\emptyset$ , is the set that has no members. Although it may seem foolish to speak of such a set, we will see that it is a useful idea.

## The Completeness Axiom

It is one thing to define an object and another to show that there really is an object that satisfies the definition. (For example, does it make sense to define the smallest positive real number?) This observation is particularly appropriate in connection with the definition of the supremum of a set. For example, the empty set is bounded above by every real number, so it has no supremum. (Think about this.) More importantly, we will see in Example 1.1.2 that properties (A)–(H) do not guarantee that every nonempty set that is bounded above has a supremum. Since this property is indispensable to the rigorous development of calculus, we take it as an axiom for the real numbers.

(I) If a nonempty set of real numbers is bounded above, then it has a supremum.

Property (I) is called *completeness*, and we say that the real number system is a *complete ordered field*. It can be shown that the real number system is essentially the only complete ordered field; that is, if an alien from another planet were to construct a mathematical system with properties (A)–(I), the alien's system would differ from the real number system only in that the alien might use different symbols for the real numbers and  $+$ ,  $\cdot$ , and  $<$ .

**Theorem 1.1.3** *If a nonempty set  $S$  of real numbers is bounded above, then  $\sup S$  is the unique real number  $\beta$  such that*

- (a)  $x \leq \beta$  for all  $x$  in  $S$ ;
- (b) if  $\epsilon > 0$  (no matter how small), there is an  $x_0$  in  $S$  such that  $x_0 > \beta - \epsilon$ .

**Proof** We first show that  $\beta = \sup S$  has properties (a) and (b). Since  $\beta$  is an upper bound of  $S$ , it must satisfy (a). Since any real number  $a$  less than  $\beta$  can be written as  $\beta - \epsilon$  with  $\epsilon = \beta - a > 0$ , (b) is just another way of saying that no number less than  $\beta$  is an upper bound of  $S$ . Hence,  $\beta = \sup S$  satisfies (a) and (b).

Now we show that there cannot be more than one real number with properties (a) and (b). Suppose that  $\beta_1 < \beta_2$  and  $\beta_2$  has property (b); thus, if  $\epsilon > 0$ , there is an  $x_0$  in  $S$  such that  $x_0 > \beta_2 - \epsilon$ . Then, by taking  $\epsilon = \beta_2 - \beta_1$ , we see that there is an  $x_0$  in  $S$  such that

$$x_0 > \beta_2 - (\beta_2 - \beta_1) = \beta_1,$$

so  $\beta_1$  cannot have property (a). Therefore, there cannot be more than one real number that satisfies both (a) and (b). ■

### Some Notation

We will often define a set  $S$  by writing  $S = \{x \mid \dots\}$ , which means that  $S$  consists of all  $x$  that satisfy the conditions to the right of the vertical bar; thus, in Example 1.1.1,

$$S = \{x \mid x < 0\} \tag{1.1.8}$$

and

$$S_1 = \{x \mid x \text{ is a negative integer}\}.$$

We will sometimes abbreviate “ $x$  is a member of  $S$ ” by  $x \in S$ , and “ $x$  is not a member of  $S$ ” by  $x \notin S$ . For example, if  $S$  is defined by (1.1.8), then

$$-1 \in S \quad \text{but} \quad 0 \notin S.$$

### The Archimedean Property

The property of the real numbers described in the next theorem is called the *Archimedean property*. Intuitively, it states that it is possible to exceed any positive number, no matter how large, by adding an arbitrary positive number, no matter how small, to itself sufficiently many times.

**Theorem 1.1.4 (Archimedean Property)** *If  $\rho$  and  $\epsilon$  are positive, then  $n\epsilon > \rho$  for some integer  $n$ .*

**Proof** The proof is by contradiction. If the statement is false,  $\rho$  is an upper bound of the set

$$S = \{x \mid x = n\epsilon, n \text{ is an integer}\}.$$

Therefore,  $S$  has a supremum  $\beta$ , by property (I). Therefore,

$$n\epsilon \leq \beta \quad \text{for all integers } n. \tag{1.1.9}$$

Since  $n + 1$  is an integer whenever  $n$  is, (1.1.9) implies that

$$(n + 1)\epsilon \leq \beta$$

and therefore

$$n\epsilon \leq \beta - \epsilon$$

for all integers  $n$ . Hence,  $\beta - \epsilon$  is an upper bound of  $S$ . Since  $\beta - \epsilon < \beta$ , this contradicts the definition of  $\beta$ . ■

### Density of the Rationals and Irrationals

**Definition 1.1.5** A set  $D$  is *dense in the reals* if every open interval  $(a, b)$  contains a member of  $D$ .

**Theorem 1.1.6** *The rational numbers are dense in the reals; that is, if  $a$  and  $b$  are real numbers with  $a < b$ , there is a rational number  $p/q$  such that  $a < p/q < b$ .*

**Proof** From Theorem 1.1.4 with  $\rho = 1$  and  $\epsilon = b - a$ , there is a positive integer  $q$  such that  $q(b - a) > 1$ . There is also an integer  $j$  such that  $j > qa$ . This is obvious if  $a \leq 0$ , and it follows from Theorem 1.1.4 with  $\epsilon = 1$  and  $\rho = qa$  if  $a > 0$ . Let  $p$  be the smallest integer such that  $p > qa$ . Then  $p - 1 \leq qa$ , so

$$qa < p \leq qa + 1.$$

Since  $1 < q(b - a)$ , this implies that

$$qa < p < qa + q(b - a) = qb,$$

so  $qa < p < qb$ . Therefore,  $a < p/q < b$ . ■

**Example 1.1.2** The rational number system is not complete; that is, a set of rational numbers may be bounded above (by rationals), but not have a rational upper bound less than any other rational upper bound. To see this, let

$$S = \{r \mid r \text{ is rational and } r^2 < 2\}.$$

If  $r \in S$ , then  $r < \sqrt{2}$ . Theorem 1.1.6 implies that if  $\epsilon > 0$  there is a rational number  $r_0$  such that  $\sqrt{2} - \epsilon < r_0 < \sqrt{2}$ , so Theorem 1.1.3 implies that  $\sqrt{2} = \sup S$ . However,  $\sqrt{2}$  is *irrational*; that is, it cannot be written as the ratio of integers (Exercise 1.1.3). Therefore, if  $r_1$  is any rational upper bound of  $S$ , then  $\sqrt{2} < r_1$ . By Theorem 1.1.6, there is a rational number  $r_2$  such that  $\sqrt{2} < r_2 < r_1$ . Since  $r_2$  is also a rational upper bound of  $S$ , this shows that  $S$  has no rational supremum. ■

Since the rational numbers have properties (A)–(H), but not (I), this example shows that (I) does not follow from (A)–(H).

**Theorem 1.1.7** *The set of irrational numbers is dense in the reals; that is, if  $a$  and  $b$  are real numbers with  $a < b$ , there is an irrational number  $t$  such that  $a < t < b$ .*

**Proof** From Theorem 1.1.6, there are rational numbers  $r_1$  and  $r_2$  such that

$$a < r_1 < r_2 < b. \quad (1.1.10)$$

Let

$$t = r_1 + \frac{1}{\sqrt{2}}(r_2 - r_1).$$

Then  $t$  is irrational (why?) and  $r_1 < t < r_2$ , so  $a < t < b$ , from (1.1.10). ■

### Infimum of a Set

A set  $S$  of real numbers is *bounded below* if there is a real number  $a$  such that  $x \geq a$  whenever  $x \in S$ . In this case,  $a$  is a *lower bound* of  $S$ . If  $a$  is a lower bound of  $S$ , so is any smaller number, because of property (G). If  $\alpha$  is a lower bound of  $S$ , but no number greater than  $\alpha$  is, then  $\alpha$  is an *infimum* of  $S$ , and we write

$$\alpha = \inf S.$$

Geometrically, this means that there are no points of  $S$  to the left of  $\alpha$ , but there is at least one point of  $S$  to the left of any number greater than  $\alpha$ .

**Theorem 1.1.8** *If a nonempty set  $S$  of real numbers is bounded below, then  $\inf S$  is the unique real number  $\alpha$  such that*

- (a)  $x \geq \alpha$  for all  $x$  in  $S$ ;
- (b) if  $\epsilon > 0$  (no matter how small), there is an  $x_0$  in  $S$  such that  $x_0 < \alpha + \epsilon$ .

**Proof** (Exercise 1.1.6)

A set  $S$  is *bounded* if there are numbers  $a$  and  $b$  such that  $a \leq x \leq b$  for all  $x$  in  $S$ . A bounded nonempty set has a unique supremum and a unique infimum, and

$$\inf S \leq \sup S \quad (1.1.11)$$

(Exercise 1.1.7). ■

### The Extended Real Number System

A nonempty set  $S$  of real numbers is *unbounded above* if it has no upper bound, or *unbounded below* if it has no lower bound. It is convenient to adjoin to the real number system two fictitious points,  $+\infty$  (which we usually write more simply as  $\infty$ ) and  $-\infty$ , and to define the order relationships between them and any real number  $x$  by

$$-\infty < x < \infty. \quad (1.1.12)$$

We call  $\infty$  and  $-\infty$  *points at infinity*. If  $S$  is a nonempty set of reals, we write

$$\sup S = \infty \quad (1.1.13)$$

to indicate that  $S$  is unbounded above, and

$$\inf S = -\infty \quad (1.1.14)$$

to indicate that  $S$  is unbounded below.

**Example 1.1.3** If

$$S = \{x \mid x < 2\},$$

then  $\sup S = 2$  and  $\inf S = -\infty$ . If

$$S = \{x \mid x \geq -2\},$$

then  $\sup S = \infty$  and  $\inf S = -2$ . If  $S$  is the set of all integers, then  $\sup S = \infty$  and  $\inf S = -\infty$ . ■

The real number system with  $\infty$  and  $-\infty$  adjoined is called the *extended real number system*, or simply the *extended reals*. A member of the extended reals differing from  $-\infty$  and  $\infty$  is *finite*; that is, an ordinary real number is finite. However, the word “finite” in “finite real number” is redundant and used only for emphasis, since we would never refer to  $\infty$  or  $-\infty$  as real numbers.

The arithmetic relationships among  $\infty$ ,  $-\infty$ , and the real numbers are defined as follows.

(a) If  $a$  is any real number, then

$$\begin{aligned} a + \infty &= \infty + a = \infty, \\ a - \infty &= -\infty + a = -\infty, \\ \frac{a}{\infty} &= \frac{a}{-\infty} = 0. \end{aligned}$$

(b) If  $a > 0$ , then

$$\begin{aligned} a \infty &= \infty a = \infty, \\ a(-\infty) &= (-\infty)a = -\infty. \end{aligned}$$

(c) If  $a < 0$ , then

$$\begin{aligned} a \infty &= \infty a = -\infty, \\ a(-\infty) &= (-\infty)a = \infty. \end{aligned}$$

We also define

$$\infty + \infty = \infty \infty = (-\infty)(-\infty) = \infty$$

and

$$-\infty - \infty = \infty(-\infty) = (-\infty)\infty = -\infty.$$

Finally, we define

$$|\infty| = |-\infty| = \infty.$$

The introduction of  $\infty$  and  $-\infty$ , along with the arithmetic and order relationships defined above, leads to simplifications in the statements of theorems. For example, the inequality (1.1.11), first stated only for bounded sets, holds for any nonempty set  $S$  if it is interpreted properly in accordance with (1.1.12) and the definitions of (1.1.13) and (1.1.14). Exercises 1.1.10(b) and 1.1.11(b) illustrate the convenience afforded by some of the arithmetic relationships with extended reals, and other examples will illustrate this further in subsequent sections.



It is not useful to define  $\infty - \infty$ ,  $0 \cdot \infty$ ,  $\infty/\infty$ , and  $0/0$ . They are called *indeterminate forms*, and left undefined. You probably studied indeterminate forms in calculus; we will look at them more carefully in Section 2.4.

## 1.1 Exercises

---

- Write the following expressions in equivalent forms not involving absolute values.
  - $a + b + |a - b|$                       **(b)**  $a + b - |a - b|$
  - $a + b + 2c + |a - b| + |a + b - 2c + |a - b||$
  - $a + b + 2c - |a - b| - |a + b - 2c - |a - b||$
- Verify that the set consisting of two members, 0 and 1, with operations defined by Eqns. (1.1.1) and (1.1.2), is a field. Then show that it is impossible to define an order  $<$  on this field that has properties **(F)**, **(G)**, and **(H)**.
- Show that  $\sqrt{2}$  is irrational. HINT: Show that if  $\sqrt{2} = m/n$ , where  $m$  and  $n$  are integers, then both  $m$  and  $n$  must be even. Obtain a contradiction from this.
- Show that  $\sqrt{p}$  is irrational if  $p$  is prime.
- Find the supremum and infimum of each  $S$ . State whether they are in  $S$ .
  - $S = \{x \mid x = -(1/n) + [1 + (-1)^n]n^2, n \geq 1\}$
  - $S = \{x \mid x^2 < 9\}$
  - $S = \{x \mid x^2 \leq 7\}$
  - $S = \{x \mid |2x + 1| < 5\}$
  - $S = \{x \mid (x^2 + 1)^{-1} > \frac{1}{2}\}$
  - $S = \{x \mid x = \text{rational and } x^2 \leq 7\}$
- Prove Theorem 1.1.8. HINT: The set  $T = \{x \mid -x \in S\}$  is bounded above if  $S$  is bounded below. Apply property **(I)** and Theorem 1.1.3 to  $T$ .
  - Show that
 
$$\inf S \leq \sup S \tag{A}$$
 for any nonempty set  $S$  of real numbers, and give necessary and sufficient conditions for equality.
  - Show that if  $S$  is unbounded then (A) holds if it is interpreted according to Eqn. (1.1.12) and the definitions of Eqns. (1.1.13) and (1.1.14).
- Let  $S$  and  $T$  be nonempty sets of real numbers such that every real number is in  $S$  or  $T$  and if  $s \in S$  and  $t \in T$ , then  $s < t$ . Prove that there is a unique real number  $\beta$  such that every real number less than  $\beta$  is in  $S$  and every real number greater than  $\beta$  is in  $T$ . (A decomposition of the reals into two sets with these properties is a *Dedekind cut*. This is known as *Dedekind's theorem*.)

9. Using properties (A)–(H) of the real numbers and taking Dedekind’s theorem (Exercise 1.1.8) as given, show that every nonempty set  $U$  of real numbers that is bounded above has a supremum. HINT: Let  $T$  be the set of upper bounds of  $U$  and  $S$  be the set of real numbers that are not upper bounds of  $U$ .
10. Let  $S$  and  $T$  be nonempty sets of real numbers and define

$$S + T = \{s + t \mid s \in S, t \in T\}.$$

- (a) Show that

$$\sup(S + T) = \sup S + \sup T \quad (\text{A})$$

if  $S$  and  $T$  are bounded above and

$$\inf(S + T) = \inf S + \inf T \quad (\text{B})$$

if  $S$  and  $T$  are bounded below.

- (b) Show that if they are properly interpreted in the extended reals, then (A) and (B) hold if  $S$  and  $T$  are arbitrary nonempty sets of real numbers.

11. Let  $S$  and  $T$  be nonempty sets of real numbers and define

$$S - T = \{s - t \mid s \in S, t \in T\}.$$

- (a) Show that if  $S$  and  $T$  are bounded, then

$$\sup(S - T) = \sup S - \inf T \quad (\text{A})$$

and

$$\inf(S - T) = \inf S - \sup T. \quad (\text{B})$$

- (b) Show that if they are properly interpreted in the extended reals, then (A) and (B) hold if  $S$  and  $T$  are arbitrary nonempty sets of real numbers.

12. Let  $S$  be a bounded nonempty set of real numbers, and let  $a$  and  $b$  be fixed real numbers. Define  $T = \{as + b \mid s \in S\}$ . Find formulas for  $\sup T$  and  $\inf T$  in terms of  $\sup S$  and  $\inf S$ . Prove your formulas.

## 1.2 MATHEMATICAL INDUCTION

If a flight of stairs is designed so that falling off any step inevitably leads to falling off the next, then falling off the first step is a sure way to end up at the bottom. Crudely expressed, this is the essence of the *principle of mathematical induction*: If the truth of a statement depending on a given integer  $n$  implies the truth of the corresponding statement with  $n$  replaced by  $n + 1$ , then the statement is true for all positive integers  $n$  if it is true for  $n = 1$ . Although you have probably studied this principle before, it is so important that it merits careful review here.

### Peano’s Postulates and Induction

The rigorous construction of the real number system starts with a set  $\mathbb{N}$  of undefined elements called *natural numbers*, with the following properties.

- (A)  $\mathbb{N}$  is nonempty.
- (B) Associated with each natural number  $n$  there is a unique natural number  $n'$  called the *successor of  $n$* .
- (C) There is a natural number  $\bar{n}$  that is not the successor of any natural number.
- (D) Distinct natural numbers have distinct successors; that is, if  $n \neq m$ , then  $n' \neq m'$ .
- (E) The only subset of  $\mathbb{N}$  that contains  $\bar{n}$  and the successors of all its elements is  $\mathbb{N}$  itself.

These axioms are known as *Peano's postulates*. The real numbers can be constructed from the natural numbers by definitions and arguments based on them. This is a formidable task that we will not undertake. We mention it to show how little you need to start with to construct the reals and, more important, to draw attention to postulate (E), which is the basis for the principle of mathematical induction.

It can be shown that the positive integers form a subset of the reals that satisfies Peano's postulates (with  $\bar{n} = 1$  and  $n' = n + 1$ ), and it is customary to regard the positive integers and the natural numbers as identical. From this point of view, the principle of mathematical induction is basically a restatement of postulate (E).

**Theorem 1.2.1 (Principle of Mathematical Induction)** *Let  $P_1, P_2, \dots, P_n, \dots$  be propositions, one for each positive integer, such that*

- (a)  $P_1$  is true;
- (b) for each positive integer  $n$ ,  $P_n$  implies  $P_{n+1}$ .

*Then  $P_n$  is true for each positive integer  $n$ .*

**Proof** Let

$$\mathbb{M} = \{n \mid n \in \mathbb{N} \text{ and } P_n \text{ is true}\}.$$

From (a),  $1 \in \mathbb{M}$ , and from (b),  $n + 1 \in \mathbb{M}$  whenever  $n \in \mathbb{M}$ . Therefore,  $\mathbb{M} = \mathbb{N}$ , by postulate (E). ■

**Example 1.2.1** Let  $P_n$  be the proposition that

$$1 + 2 + \cdots + n = \frac{n(n+1)}{2}. \quad (1.2.1)$$

Then  $P_1$  is the proposition that  $1 = 1$ , which is certainly true. If  $P_n$  is true, then adding  $n + 1$  to both sides of (1.2.1) yields

$$\begin{aligned} (1 + 2 + \cdots + n) + (n + 1) &= \frac{n(n+1)}{2} + (n + 1) \\ &= (n + 1) \left( \frac{n}{2} + 1 \right) \\ &= \frac{(n + 1)(n + 2)}{2}, \end{aligned}$$

or

$$1 + 2 + \cdots + (n + 1) = \frac{(n + 1)(n + 2)}{2},$$

which is  $P_{n+1}$ , since it has the form of (1.2.1), with  $n$  replaced by  $n + 1$ . Hence,  $P_n$  implies  $P_{n+1}$ , so (1.2.1) is true for all  $n$ , by Theorem 1.2.1. ■

A proof based on Theorem 1.2.1 is an *induction proof*, or *proof by induction*. The assumption that  $P_n$  is true is the *induction assumption*. (Theorem 1.2.3 permits a kind of induction proof in which the induction assumption takes a different form.)

Induction, by definition, can be used only to verify results conjectured by other means. Thus, in Example 1.2.1 we did not use induction to *find* the sum

$$s_n = 1 + 2 + \cdots + n; \quad (1.2.2)$$

rather, we *verified* that

$$s_n = \frac{n(n+1)}{2}. \quad (1.2.3)$$

How you guess what to prove by induction depends on the problem and your approach to it. For example, (1.2.3) might be conjectured after observing that

$$s_1 = 1 = \frac{1 \cdot 2}{2}, \quad s_2 = 3 = \frac{2 \cdot 3}{2}, \quad s_3 = 6 = \frac{4 \cdot 3}{2}.$$

However, this requires sufficient insight to recognize that these results are of the form (1.2.3) for  $n = 1, 2$ , and  $3$ . Although it is easy to prove (1.2.3) by induction once it has been conjectured, induction is not the most efficient way to find  $s_n$ , which can be obtained quickly by rewriting (1.2.2) as

$$s_n = n + (n-1) + \cdots + 1$$

and adding this to (1.2.2) to obtain

$$2s_n = [n+1] + [(n-1)+2] + \cdots + [1+n].$$

There are  $n$  bracketed expressions on the right, and the terms in each add up to  $n+1$ ; hence,

$$2s_n = n(n+1),$$

which yields (1.2.3).

The next two examples deal with problems for which induction is a natural and efficient method of solution.

**Example 1.2.2** Let  $a_1 = 1$  and

$$a_{n+1} = \frac{1}{n+1}a_n, \quad n \geq 1 \quad (1.2.4)$$

(we say that  $a_n$  is defined *inductively*), and suppose that we wish to find an explicit formula for  $a_n$ . By considering  $n = 1, 2$ , and  $3$ , we find that

$$a_1 = \frac{1}{1}, \quad a_2 = \frac{1}{1 \cdot 2}, \quad \text{and} \quad a_3 = \frac{1}{1 \cdot 2 \cdot 3},$$

and therefore we conjecture that

$$a_n = \frac{1}{n!}. \quad (1.2.5)$$

This is given for  $n = 1$ . If we assume it is true for some  $n$ , substituting it into (1.2.4) yields

$$a_{n+1} = \frac{1}{n+1} \frac{1}{n!} = \frac{1}{(n+1)!},$$

which is (1.2.5) with  $n$  replaced by  $n + 1$ . Therefore, (1.2.5) is true for every positive integer  $n$ , by Theorem 1.2.1.

**Example 1.2.3** For each nonnegative integer  $n$ , let  $x_n$  be a real number and suppose that

$$|x_{n+1} - x_n| \leq r|x_n - x_{n-1}|, \quad n \geq 1, \quad (1.2.6)$$

where  $r$  is a fixed positive number. By considering (1.2.6) for  $n = 1, 2$ , and  $3$ , we find that

$$\begin{aligned} |x_2 - x_1| &\leq r|x_1 - x_0|, \\ |x_3 - x_2| &\leq r|x_2 - x_1| \leq r^2|x_1 - x_0|, \\ |x_4 - x_3| &\leq r|x_3 - x_2| \leq r^3|x_1 - x_0|. \end{aligned}$$

Therefore, we conjecture that

$$|x_n - x_{n-1}| \leq r^{n-1}|x_1 - x_0| \quad \text{if } n \geq 1. \quad (1.2.7)$$

This is trivial for  $n = 1$ . If it is true for some  $n$ , then (1.2.6) and (1.2.7) imply that

$$|x_{n+1} - x_n| \leq r(r^{n-1}|x_1 - x_0|), \quad \text{so } |x_{n+1} - x_n| \leq r^n|x_1 - x_0|,$$

which is proposition (1.2.7) with  $n$  replaced by  $n + 1$ . Hence, (1.2.7) is true for every positive integer  $n$ , by Theorem 1.2.1. ■

The major effort in an induction proof (after  $P_1, P_2, \dots, P_n, \dots$  have been formulated) is usually directed toward showing that  $P_n$  implies  $P_{n+1}$ . However, it is important to verify  $P_1$ , since  $P_n$  may imply  $P_{n+1}$  even if some or all of the propositions  $P_1, P_2, \dots, P_n, \dots$  are false.

**Example 1.2.4** Let  $P_n$  be the proposition that  $2n - 1$  is divisible by 2. If  $P_n$  is true then  $P_{n+1}$  is also, since

$$2n + 1 = (2n - 1) + 2.$$

However, we cannot conclude that  $P_n$  is true for  $n \geq 1$ . In fact,  $P_n$  is false for every  $n$ . ■

The following formulation of the principle of mathematical induction permits us to start induction proofs with an arbitrary integer, rather than 1, as required in Theorem 1.2.1.

**Theorem 1.2.2** Let  $n_0$  be any integer (positive, negative, or zero). Let  $P_{n_0}, P_{n_0+1}, \dots, P_n, \dots$  be propositions, one for each integer  $n \geq n_0$ , such that

- (a)  $P_{n_0}$  is true;
- (b) for each integer  $n \geq n_0$ ,  $P_n$  implies  $P_{n+1}$ .

Then  $P_n$  is true for every integer  $n \geq n_0$ .

**Proof** For  $m \geq 1$ , let  $Q_m$  be the proposition defined by  $Q_m = P_{m+n_0-1}$ . Then  $Q_1 = P_{n_0}$  is true by (a). If  $m \geq 1$  and  $Q_m = P_{m+n_0-1}$  is true, then  $Q_{m+1} = P_{m+n_0}$  is true by (b) with  $n$  replaced by  $m + n_0 - 1$ . Therefore,  $Q_m$  is true for all  $m \geq 1$  by Theorem 1.2.1 with  $P$  replaced by  $Q$  and  $n$  replaced by  $m$ . This is equivalent to the statement that  $P_n$  is true for all  $n \geq n_0$ . ■

**Example 1.2.5** Consider the proposition  $P_n$  that

$$3n + 16 > 0.$$

If  $P_n$  is true, then so is  $P_{n+1}$ , since

$$\begin{aligned} 3(n+1) + 16 &= 3n + 3 + 16 \\ &= (3n + 16) + 3 > 0 + 3 \text{ (by the induction assumption)} \\ &> 0. \end{aligned}$$

The smallest  $n_0$  for which  $P_{n_0}$  is true is  $n_0 = -5$ . Hence,  $P_n$  is true for  $n \geq -5$ , by Theorem 1.2.2.

**Example 1.2.6** Let  $P_n$  be the proposition that

$$n! - 3^n > 0.$$

If  $P_n$  is true, then

$$\begin{aligned} (n+1)! - 3^{n+1} &= n!(n+1) - 3^{n+1} \\ &> 3^n(n+1) - 3^{n+1} \text{ (by the induction assumption)} \\ &= 3^n(n-2). \end{aligned}$$

Therefore,  $P_n$  implies  $P_{n+1}$  if  $n > 2$ . By trial and error,  $n_0 = 7$  is the smallest integer such that  $P_{n_0}$  is true; hence,  $P_n$  is true for  $n \geq 7$ , by Theorem 1.2.2. ■

The next theorem is a useful consequence of the principle of mathematical induction.

**Theorem 1.2.3** Let  $n_0$  be any integer (positive, negative, or zero). Let  $P_{n_0}, P_{n_0+1}, \dots, P_n, \dots$  be propositions, one for each integer  $n \geq n_0$ , such that

- (a)  $P_{n_0}$  is true;
- (b) for  $n \geq n_0$ ,  $P_{n+1}$  is true if  $P_{n_0}, P_{n_0+1}, \dots, P_n$  are all true.

Then  $P_n$  is true for  $n \geq n_0$ .

**Proof** For  $n \geq n_0$ , let  $Q_n$  be the proposition that  $P_{n_0}, P_{n_0+1}, \dots, P_n$  are all true. Then  $Q_{n_0}$  is true by (a). Since  $Q_n$  implies  $P_{n+1}$  by (b), and  $Q_{n+1}$  is true if  $Q_n$  and  $P_{n+1}$  are both true, Theorem 1.2.2 implies that  $Q_n$  is true for all  $n \geq n_0$ . Therefore,  $P_n$  is true for all  $n \geq n_0$ . ■

**Example 1.2.7** An integer  $p > 1$  is a *prime* if it cannot be factored as  $p = rs$  where  $r$  and  $s$  are integers and  $1 < r, s < p$ . Thus, 2, 3, 5, 7, and 11 are primes, and, although 4, 6, 8, 9, and 10 are not, they are products of primes:

$$4 = 2 \cdot 2, \quad 6 = 2 \cdot 3, \quad 8 = 2 \cdot 2 \cdot 2, \quad 9 = 3 \cdot 3, \quad 10 = 2 \cdot 5.$$

These observations suggest that each integer  $n \geq 2$  is a prime or a product of primes. Let this proposition be  $P_n$ . Then  $P_2$  is true, but neither Theorem 1.2.1 nor Theorem 1.2.2 apply, since  $P_n$  does not imply  $P_{n+1}$  in any obvious way. (For example, it is not evident from  $24 = 2 \cdot 2 \cdot 2 \cdot 3$  that 25 is a product of primes.) However, Theorem 1.2.3 yields the stated result, as follows. Suppose that  $n \geq 2$  and  $P_2, \dots, P_n$  are true. Either  $n + 1$  is a prime or

$$n + 1 = rs, \tag{1.2.8}$$

where  $r$  and  $s$  are integers and  $1 < r, s < n$ , so  $P_r$  and  $P_s$  are true by assumption. Hence,  $r$  and  $s$  are primes or products of primes and (1.2.8) implies that  $n + 1$  is a product of primes. We have now proved  $P_{n+1}$  (that  $n + 1$  is a prime or a product of primes). Therefore,  $P_n$  is true for all  $n \geq 2$ , by Theorem 1.2.3.

## 1.2 Exercises

---

Prove the assertions in Exercises 1.2.1–1.2.6 by induction.

1. The sum of the first  $n$  odd integers is  $n^2$ .

2.  $1^2 + 2^2 + \dots + n^2 = \frac{n(n+1)(2n+1)}{6}$ .

3.  $1^2 + 3^2 + \dots + (2n-1)^2 = \frac{n(4n^2-1)}{3}$ .

4. If  $a_1, a_2, \dots, a_n$  are arbitrary real numbers, then

$$|a_1 + a_2 + \dots + a_n| \leq |a_1| + |a_2| + \dots + |a_n|.$$

5. If  $a_i \geq 0, i \geq 1$ , then

$$(1 + a_1)(1 + a_2) \cdots (1 + a_n) \geq 1 + a_1 + a_2 + \dots + a_n.$$

6. If  $0 \leq a_i \leq 1, i \geq 1$ , then

$$(1 - a_1)(1 - a_2) \cdots (1 - a_n) \geq 1 - a_1 - a_2 \cdots - a_n.$$

7. Suppose that  $s_0 > 0$  and  $s_n = 1 - e^{-s_{n-1}}$ ,  $n \geq 1$ . Show that  $0 < s_n < 1$ ,  $n \geq 1$ .
8. Suppose that  $R > 0$ ,  $x_0 > 0$ , and

$$x_{n+1} = \frac{1}{2} \left( \frac{R}{x_n} + x_n \right), \quad n \geq 0.$$

Prove: For  $n \geq 1$ ,  $x_n > x_{n+1} > \sqrt{R}$  and

$$x_n - \sqrt{R} \leq \frac{1}{2^n} \frac{(x_0 - \sqrt{R})^2}{x_0}.$$

9. Find and prove by induction an explicit formula for  $a_n$  if  $a_1 = 1$  and, for  $n \geq 1$ ,
- (a)  $a_{n+1} = \frac{a_n}{(n+1)(2n+1)}$       (b)  $a_{n+1} = \frac{3a_n}{(2n+2)(2n+3)}$
- (c)  $a_{n+1} = \frac{2n+1}{n+1} a_n$       (d)  $a_{n+1} = \left(1 + \frac{1}{n}\right)^n a_n$
10. Let  $a_1 = 0$  and  $a_{n+1} = (n+1)a_n$  for  $n \geq 1$ , and let  $P_n$  be the proposition that  $a_n = n!$
- (a) Show that  $P_n$  implies  $P_{n+1}$ .
- (b) Is there an integer  $n$  for which  $P_n$  is true?
11. Let  $P_n$  be the proposition that

$$1 + 2 + \cdots + n = \frac{(n+2)(n-1)}{2}.$$

- (a) Show that  $P_n$  implies  $P_{n+1}$ .
- (b) Is there an integer  $n$  for which  $P_n$  is true?
12. For what integers  $n$  is

$$\frac{1}{n!} > \frac{8^n}{(2n)!}?$$

Prove your answer by induction.

13. Let  $a$  be an integer  $\geq 2$ .
- (a) Show by induction that if  $n$  is a nonnegative integer, then  $n = aq + r$ , where  $q$  (quotient) and  $r$  (remainder) are integers and  $0 \leq r < a$ .
- (b) Show that the result of (a) is true if  $n$  is an arbitrary integer (not necessarily nonnegative).
- (c) Show that there is only one way to write a given integer  $n$  in the form  $n = aq + r$ , where  $q$  and  $r$  are integers and  $0 \leq r < a$ .
14. Take the following statement as given: If  $p$  is a prime and  $a$  and  $b$  are integers such that  $p$  divides the product  $ab$ , then  $p$  divides  $a$  or  $b$ .



- (a) Prove: If  $p, p_1, \dots, p_k$  are positive primes and  $p$  divides the product  $p_1 \cdots p_k$ , then  $p = p_i$  for some  $i$  in  $\{1, \dots, k\}$ .
- (b) Let  $n$  be an integer  $> 1$ . Show that the prime factorization of  $n$  found in Example 1.2.7 is unique in the following sense: If

$$n = p_1 \cdots p_r \quad \text{and} \quad n = q_1 q_2 \cdots q_s,$$

where  $p_1, \dots, p_r, q_1, \dots, q_s$  are positive primes, then  $r = s$  and  $\{q_1, \dots, q_r\}$  is a permutation of  $\{p_1, \dots, p_r\}$ .

15. Let  $a_1 = a_2 = 5$  and

$$a_{n+1} = a_n + 6a_{n-1}, \quad n \geq 2.$$

Show by induction that  $a_n = 3^n - (-2)^n$  if  $n \geq 1$ .

16. Let  $a_1 = 2, a_2 = 0, a_3 = -14$ , and

$$a_{n+1} = 9a_n - 23a_{n-1} + 15a_{n-2}, \quad n \geq 3.$$

Show by induction that  $a_n = 3^{n-1} - 5^{n-1} + 2, n \geq 1$ .

17. The *Fibonacci numbers*  $\{F_n\}_{n=1}^\infty$  are defined by  $F_1 = F_2 = 1$  and

$$F_{n+1} = F_n + F_{n-1}, \quad n \geq 2.$$

Prove by induction that

$$F_n = \frac{(1 + \sqrt{5})^n - (1 - \sqrt{5})^n}{2^n \sqrt{5}}, \quad n \geq 1.$$

18. Prove by induction that

$$\int_0^1 y^n (1-y)^r dy = \frac{n!}{(r+1)(r+2)\cdots(r+n+1)}$$

if  $n$  is a nonnegative integer and  $r > -1$ .

19. Suppose that  $m$  and  $n$  are integers, with  $0 \leq m \leq n$ . The *binomial coefficient*  $\binom{n}{m}$  is the coefficient of  $t^m$  in the expansion of  $(1+t)^n$ ; that is,

$$(1+t)^n = \sum_{m=0}^n \binom{n}{m} t^m.$$

From this definition it follows immediately that

$$\binom{n}{0} = \binom{n}{n} = 1, \quad n \geq 0.$$

For convenience we define

$$\binom{n}{-1} = \binom{n}{n+1} = 0, \quad n \geq 0.$$

(a) Show that

$$\binom{n+1}{m} = \binom{n}{m} + \binom{n}{m-1}, \quad 0 \leq m \leq n,$$

and use this to show by induction on  $n$  that

$$\binom{n}{m} = \frac{n!}{m!(n-m)!}, \quad 0 \leq m \leq n.$$

(b) Show that

$$\sum_{m=0}^n (-1)^m \binom{n}{m} = 0 \quad \text{and} \quad \sum_{m=0}^n \binom{n}{m} = 2^n.$$

(c) Show that

$$(x+y)^n = \sum_{m=0}^n \binom{n}{m} x^m y^{n-m}.$$

(This is the *binomial theorem*.)

20. Use induction to find an  $n$ th antiderivative of  $\log x$ , the natural logarithm of  $x$ .

21. Let  $f_1(x_1) = g_1(x_1) = x_1$ . For  $n \geq 2$ , let

$$f_n(x_1, x_2, \dots, x_n) = f_{n-1}(x_1, x_2, \dots, x_{n-1}) + 2^{n-2}x_n + |f_{n-1}(x_1, x_2, \dots, x_{n-1}) - 2^{n-2}x_n|$$

and

$$g_n(x_1, x_2, \dots, x_n) = g_{n-1}(x_1, x_2, \dots, x_{n-1}) + 2^{n-2}x_n - |g_{n-1}(x_1, x_2, \dots, x_{n-1}) - 2^{n-2}x_n|.$$

Find explicit formulas for  $f_n(x_1, x_2, \dots, x_n)$  and  $g_n(x_1, x_2, \dots, x_n)$ .

22. Prove by induction that

$$\sin x + \sin 3x + \dots + \sin(2n-1)x = \frac{1 - \cos 2nx}{2 \sin x}, \quad n \geq 1.$$

HINT: You will need trigonometric identities that you can derive from the identities

$$\begin{aligned} \cos(A-B) &= \cos A \cos B + \sin A \sin B, \\ \cos(A+B) &= \cos A \cos B - \sin A \sin B. \end{aligned}$$

Take these two identities as given.

- 23.** Suppose that  $a_1 \leq a_2 \leq \cdots \leq a_n$  and  $b_1 \leq b_2 \leq \cdots \leq b_n$ . Let  $\{\ell_1, \ell_2, \dots, \ell_n\}$  be a permutation of  $\{1, 2, \dots, n\}$ , and define

$$Q(\ell_1, \ell_2, \dots, \ell_n) = \sum_{i=1}^n (a_i - b_{\ell_i})^2.$$

Show that

$$Q(\ell_1, \ell_2, \dots, \ell_n) \geq Q(1, 2, \dots, n).$$

### 1.3 THE REAL LINE

One of our objectives is to develop rigorously the concepts of limit, continuity, differentiability, and integrability, which you have seen in calculus. To do this requires a better understanding of the real numbers than is provided in calculus. The purpose of this section is to develop this understanding. Since the utility of the concepts introduced here will not become apparent until we are well into the study of limits and continuity, you should reserve judgment on their value until they are applied. As this occurs, you should reread the applicable parts of this section. This applies especially to the concept of an open covering and to the Heine–Borel and Bolzano–Weierstrass theorems, which will seem mysterious at first.

We assume that you are familiar with the geometric interpretation of the real numbers as points on a line. We will not prove that this interpretation is legitimate, for two reasons: (1) the proof requires an excursion into the foundations of Euclidean geometry, which is not the purpose of this book; (2) although we will use geometric terminology and intuition in discussing the reals, we will base all proofs on properties **(A)**–**(I)** (Section 1.1) and their consequences, not on geometric arguments.

Henceforth, we will use the terms *real number system* and *real line* synonymously and denote both by the symbol  $\mathbb{R}$ ; also, we will often refer to a real number as a *point* (on the real line).

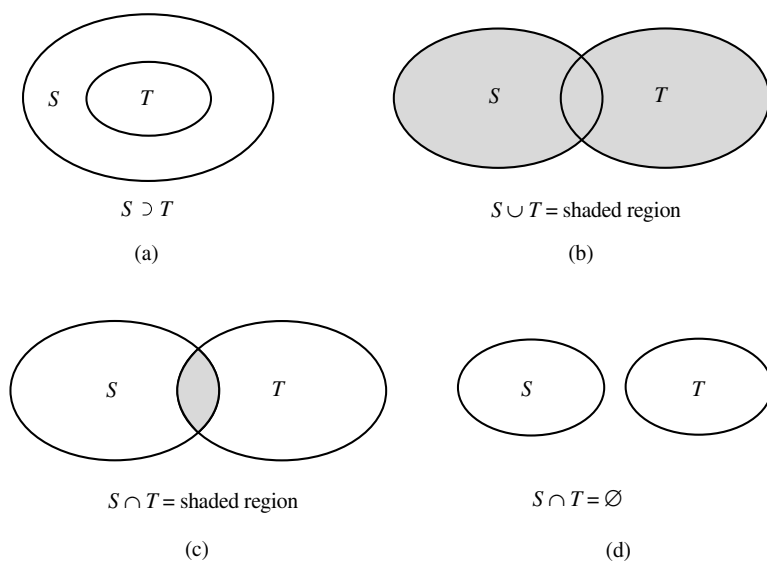
#### Some Set Theory

In this section we are interested in sets of points on the real line; however, we will consider other kinds of sets in subsequent sections. The following definition applies to arbitrary sets, with the understanding that the members of all sets under consideration in any given context come from a specific collection of elements, called the *universal set*. In this section the universal set is the real numbers.

**Definition 1.3.1** Let  $S$  and  $T$  be sets.

- (a)  $S$  contains  $T$ , and we write  $S \supset T$  or  $T \subset S$ , if every member of  $T$  is also in  $S$ . In this case,  $T$  is a *subset* of  $S$ .
- (b)  $S - T$  is the set of elements that are in  $S$  but not in  $T$ .
- (c)  $S$  equals  $T$ , and we write  $S = T$ , if  $S$  contains  $T$  and  $T$  contains  $S$ ; thus,  $S = T$  if and only if  $S$  and  $T$  have the same members.

- (d)  $S$  *strictly contains*  $T$  if  $S$  contains  $T$  but  $T$  does not contain  $S$ ; that is, if every member of  $T$  is also in  $S$ , but at least one member of  $S$  is not in  $T$  (Figure 1.3.1).
- (e) The *complement* of  $S$ , denoted by  $S^c$ , is the set of elements in the universal set that are not in  $S$ .
- (f) The *union* of  $S$  and  $T$ , denoted by  $S \cup T$ , is the set of elements in at least one of  $S$  and  $T$  (Figure 1.3.1(b)).
- (g) The *intersection* of  $S$  and  $T$ , denoted by  $S \cap T$ , is the set of elements in both  $S$  and  $T$  (Figure 1.3.1(c)). If  $S \cap T = \emptyset$  (the empty set), then  $S$  and  $T$  are *disjoint sets* (Figure 1.3.1(d)).
- (h) A set with only one member  $x_0$  is a *singleton set*, denoted by  $\{x_0\}$ .

**Figure 1.3.1**

**Example 1.3.1** Let

$$S = \{x \mid 0 < x < 1\}, \quad T = \{x \mid 0 < x < 1 \text{ and } x \text{ is rational}\},$$

and

$$U = \{x \mid 0 < x < 1 \text{ and } x \text{ is irrational}\}.$$

Then  $S \supset T$  and  $S \supset U$ , and the inclusion is strict in both cases. The unions of pairs of these sets are

$$S \cup T = S, \quad S \cup U = S, \quad \text{and} \quad T \cup U = S,$$

and their intersections are

$$S \cap T = T, \quad S \cap U = U, \quad \text{and} \quad T \cap U = \emptyset.$$

Also,

$$S - U = T \quad \text{and} \quad S - T = U. \quad \blacksquare$$

Every set  $S$  contains the empty set  $\emptyset$ , for to say that  $\emptyset$  is not contained in  $S$  is to say that some member of  $\emptyset$  is not in  $S$ , which is absurd since  $\emptyset$  has no members. If  $S$  is any set, then

$$(S^c)^c = S \quad \text{and} \quad S \cap S^c = \emptyset.$$

If  $S$  is a set of real numbers, then  $S \cup S^c = \mathbb{R}$ .

The definitions of union and intersection have generalizations: If  $\mathcal{F}$  is an arbitrary collection of sets, then  $\cup \{S \mid S \in \mathcal{F}\}$  is the set of all elements that are members of at least one of the sets in  $\mathcal{F}$ , and  $\cap \{S \mid S \in \mathcal{F}\}$  is the set of all elements that are members of every set in  $\mathcal{F}$ . The union and intersection of finitely many sets  $S_1, \dots, S_n$  are also written as  $\bigcup_{k=1}^n S_k$  and  $\bigcap_{k=1}^n S_k$ . The union and intersection of an infinite sequence  $\{S_k\}_{k=1}^{\infty}$  of sets are written as  $\bigcup_{k=1}^{\infty} S_k$  and  $\bigcap_{k=1}^{\infty} S_k$ .

**Example 1.3.2** If  $\mathcal{F}$  is the collection of sets

$$S_\rho = \{x \mid \rho < x \leq 1 + \rho\}, \quad 0 < \rho \leq 1/2,$$

then

$$\bigcup \{S_\rho \mid S_\rho \in \mathcal{F}\} = \{x \mid 0 < x \leq 3/2\} \quad \text{and} \quad \bigcap \{S_\rho \mid S_\rho \in \mathcal{F}\} = \{x \mid 1/2 < x \leq 1\}.$$

**Example 1.3.3** If, for each positive integer  $k$ , the set  $S_k$  is the set of real numbers that can be written as  $x = m/k$  for some integer  $m$ , then  $\bigcup_{k=1}^{\infty} S_k$  is the set of rational numbers and  $\bigcap_{k=1}^{\infty} S_k$  is the set of integers.

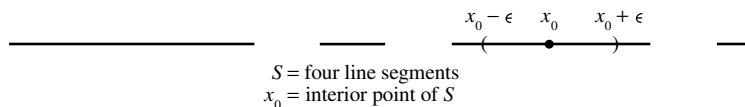
## Open and Closed Sets

If  $a$  and  $b$  are in the extended reals and  $a < b$ , then the *open interval*  $(a, b)$  is defined by

$$(a, b) = \{x \mid a < x < b\}.$$

The open intervals  $(a, \infty)$  and  $(-\infty, b)$  are *semi-infinite* if  $a$  and  $b$  are finite, and  $(-\infty, \infty)$  is the entire real line.

**Definition 1.3.2** If  $x_0$  is a real number and  $\epsilon > 0$ , then the open interval  $(x_0 - \epsilon, x_0 + \epsilon)$  is an  $\epsilon$ -neighborhood of  $x_0$ . If a set  $S$  contains an  $\epsilon$ -neighborhood of  $x_0$ , then  $S$  is a *neighborhood* of  $x_0$ , and  $x_0$  is an *interior point* of  $S$  (Figure 1.3.2). The set of interior points of  $S$  is the *interior* of  $S$ , denoted by  $S^0$ . If every point of  $S$  is an interior point (that is,  $S^0 = S$ ), then  $S$  is *open*. A set  $S$  is *closed* if  $S^c$  is open.

**Figure 1.3.2**

The idea of neighborhood is fundamental and occurs in many other contexts, some of which we will see later in this book. Whatever the context, the idea is the same: some definition of “closeness” is given (for example, two real numbers are “close” if their difference is “small”), and a neighborhood of a point  $x_0$  is a set that contains all points sufficiently close to  $x_0$ .

**Example 1.3.4** An open interval  $(a, b)$  is an open set, because if  $x_0 \in (a, b)$  and  $\epsilon \leq \min\{x_0 - a, b - x_0\}$ , then

$$(x_0 - \epsilon, x_0 + \epsilon) \subset (a, b).$$

The entire line  $\mathbb{R} = (-\infty, \infty)$  is open, and therefore  $\emptyset (= \mathbb{R}^c)$  is closed. However,  $\emptyset$  is also open, for to deny this is to say that  $\emptyset$  contains a point that is not an interior point, which is absurd because  $\emptyset$  contains no points. Since  $\emptyset$  is open,  $\mathbb{R} (= \emptyset^c)$  is closed. Thus,  $\mathbb{R}$  and  $\emptyset$  are both open and closed. They are the only subsets of  $\mathbb{R}$  with this property (Exercise 1.3.18). ■

A *deleted neighborhood* of a point  $x_0$  is a set that contains every point of some neighborhood of  $x_0$  except for  $x_0$  itself. For example,

$$S = \{x \mid 0 < |x - x_0| < \epsilon\}$$

is a deleted neighborhood of  $x_0$ . We also say that it is a *deleted  $\epsilon$ -neighborhood* of  $x_0$ .

**Theorem 1.3.3**

(a) *The union of open sets is open.*

(b) *The intersection of closed sets is closed.*

*These statements apply to arbitrary collections, finite or infinite, of open and closed sets.*

**Proof** (a) Let  $\mathcal{G}$  be a collection of open sets and

$$S = \cup \{G \mid G \in \mathcal{G}\}.$$

If  $x_0 \in S$ , then  $x_0 \in G_0$  for some  $G_0$  in  $\mathcal{G}$ , and since  $G_0$  is open, it contains some  $\epsilon$ -neighborhood of  $x_0$ . Since  $G_0 \subset S$ , this  $\epsilon$ -neighborhood is in  $S$ , which is consequently a neighborhood of  $x_0$ . Thus,  $S$  is a neighborhood of each of its points, and therefore open, by definition.

(b) Let  $\mathcal{F}$  be a collection of closed sets and  $T = \cap \{F \mid F \in \mathcal{F}\}$ . Then  $T^c = \cup \{F^c \mid F \in \mathcal{F}\}$  (Exercise 1.3.7) and, since each  $F^c$  is open,  $T^c$  is open, from (a). Therefore,  $T$  is closed, by definition. ■

**Example 1.3.5** If  $-\infty < a < b < \infty$ , the set

$$[a, b] = \{x \mid a \leq x \leq b\}$$

is closed, since its complement is the union of the open sets  $(-\infty, a)$  and  $(b, \infty)$ . We say that  $[a, b]$  is a *closed interval*. The set

$$[a, b) = \{x \mid a \leq x < b\}$$

is a *half-closed* or *half-open interval* if  $-\infty < a < b < \infty$ , as is

$$(a, b] = \{x \mid a < x \leq b\};$$

however, neither of these sets is open or closed. (Why not?) *Semi-infinite closed intervals* are sets of the form

$$[a, \infty) = \{x \mid a \leq x\} \quad \text{and} \quad (-\infty, a] = \{x \mid x \leq a\},$$

where  $a$  is finite. They are closed sets, since their complements are the open intervals  $(-\infty, a)$  and  $(a, \infty)$ , respectively. ■

Example 1.3.4 shows that a set may be both open and closed, and Example 1.3.5 shows that a set may be neither. Thus, open and closed are not opposites in this context, as they are in everyday speech.

**Example 1.3.6** From Theorem 1.3.3 and Example 1.3.4, the union of any collection of open intervals is an open set. (In fact, it can be shown that every nonempty open subset of  $\mathbb{R}$  is the union of open intervals.) From Theorem 1.3.3 and Example 1.3.5, the intersection of any collection of closed intervals is closed. ■

It can be shown that the intersection of finitely many open sets is open, and that the union of finitely many closed sets is closed. However, the intersection of infinitely many open sets need not be open, and the union of infinitely many closed sets need not be closed (Exercises 1.3.8 and 1.3.9).

**Definition 1.3.4** Let  $S$  be a subset of  $\mathcal{R}$ . Then

- (a)  $x_0$  is a *limit point* of  $S$  if every deleted neighborhood of  $x_0$  contains a point of  $S$ .
- (b)  $x_0$  is a *boundary point* of  $S$  if every neighborhood of  $x_0$  contains at least one point in  $S$  and one not in  $S$ . The set of boundary points of  $S$  is the *boundary* of  $S$ , denoted by  $\partial S$ . The *closure* of  $S$ , denoted by  $\overline{S}$ , is  $\overline{S} = S \cup \partial S$ .
- (c)  $x_0$  is an *isolated point* of  $S$  if  $x_0 \in S$  and there is a neighborhood of  $x_0$  that contains no other point of  $S$ .
- (d)  $x_0$  is *exterior* to  $S$  if  $x_0$  is in the interior of  $S^c$ . The collection of such points is the *exterior* of  $S$ .

**Example 1.3.7** Let  $S = (-\infty, -1] \cup (1, 2) \cup \{3\}$ . Then

- (a) The set of limit points of  $S$  is  $(-\infty, -1] \cup [1, 2]$ .  
 (b)  $\partial S = \{-1, 1, 2, 3\}$  and  $\bar{S} = (-\infty, -1] \cup [1, 2] \cup \{3\}$ .  
 (c) 3 is the only isolated point of  $S$ .  
 (d) The exterior of  $S$  is  $(-1, 1) \cup (2, 3) \cup (3, \infty)$ .

**Example 1.3.8** For  $n \geq 1$ , let

$$I_n = \left[ \frac{1}{2n+1}, \frac{1}{2n} \right] \quad \text{and} \quad S = \bigcup_{n=1}^{\infty} I_n.$$

Then

- (a) The set of limit points of  $S$  is  $S \cup \{0\}$ .  
 (b)  $\partial S = \{x \mid x = 0 \text{ or } x = 1/n \text{ (} n \geq 2)\}$  and  $\bar{S} = S \cup \{0\}$ .  
 (c)  $S$  has no isolated points.  
 (d) The exterior of  $S$  is

$$(-\infty, 0) \cup \left[ \bigcup_{n=1}^{\infty} \left( \frac{1}{2n+2}, \frac{1}{2n+1} \right) \right] \cup \left( \frac{1}{2}, \infty \right).$$

**Example 1.3.9** Let  $S$  be the set of rational numbers. Since every interval contains a rational number (Theorem 1.1.6), every real number is a limit point of  $S$ ; thus,  $\bar{S} = \mathbb{R}$ . Since every interval also contains an irrational number (Theorem 1.1.7), every real number is a boundary point of  $S$ ; thus  $\partial S = \mathbb{R}$ . The interior and exterior of  $S$  are both empty, and  $S$  has no isolated points.  $S$  is neither open nor closed. ■

The next theorem says that  $S$  is closed if and only if  $S = \bar{S}$  (Exercise 1.3.14).

**Theorem 1.3.5** *A set  $S$  is closed if and only if no point of  $S^c$  is a limit point of  $S$ .*

**Proof** Suppose that  $S$  is closed and  $x_0 \in S^c$ . Since  $S^c$  is open, there is a neighborhood of  $x_0$  that is contained in  $S^c$  and therefore contains no points of  $S$ . Hence,  $x_0$  cannot be a limit point of  $S$ . For the converse, if no point of  $S^c$  is a limit point of  $S$  then every point in  $S^c$  must have a neighborhood contained in  $S^c$ . Therefore,  $S^c$  is open and  $S$  is closed. ■

Theorem 1.3.5 is usually stated as follows.

**Corollary 1.3.6** *A set is closed if and only if it contains all its limit points.*

Theorem 1.3.5 and Corollary 1.3.6 are equivalent. However, we stated the theorem as we did because students sometimes incorrectly conclude from the corollary that a closed set must have limit points. The corollary does not say this. If  $S$  has no limit points, then the set of limit points is empty and therefore contained in  $S$ . Hence, a set with no limit points is closed according to the corollary, in agreement with Theorem 1.3.5. For example, any finite set is closed. More generally,  $S$  is closed if there is a  $\delta > 0$  such  $|x - y| \geq \delta$  for every pair  $\{x, y\}$  of distinct points in  $S$ .



## Open Coverings

A collection  $\mathcal{H}$  of open sets is an *open covering* of a set  $S$  if every point in  $S$  is contained in a set  $H$  belonging to  $\mathcal{H}$ ; that is, if  $S \subset \cup \{H \mid H \in \mathcal{H}\}$ .

**Example 1.3.10** The sets

$$S_1 = [0, 1], S_2 = \{1, 2, \dots, n, \dots\},$$

$$S_3 = \left\{1, \frac{1}{2}, \dots, \frac{1}{n}, \dots\right\}, \quad \text{and} \quad S_4 = (0, 1)$$

are covered by the families of open intervals

$$\mathcal{H}_1 = \left\{ \left( x - \frac{1}{N}, x + \frac{1}{N} \right) \mid 0 < x < 1 \right\}, \quad (N = \text{positive integer}),$$

$$\mathcal{H}_2 = \left\{ \left( n - \frac{1}{4}, n + \frac{1}{4} \right) \mid n = 1, 2, \dots \right\},$$

$$\mathcal{H}_3 = \left\{ \left( \frac{1}{n + \frac{1}{2}}, \frac{1}{n - \frac{1}{2}} \right) \mid n = 1, 2, \dots \right\},$$

and

$$\mathcal{H}_4 = \{(0, \rho) \mid 0 < \rho < 1\},$$

respectively.

**Theorem 1.3.7 (Heine–Borel Theorem)** *If  $\mathcal{H}$  is an open covering of a closed and bounded subset  $S$  of the real line, then  $S$  has an open covering  $\mathcal{F}$  consisting of finitely many open sets belonging to  $\mathcal{H}$ .*

**Proof** Since  $S$  is bounded, it has an infimum  $\alpha$  and a supremum  $\beta$ , and, since  $S$  is closed,  $\alpha$  and  $\beta$  belong to  $S$  (Exercise 1.3.17). Define

$$S_t = S \cap [\alpha, t] \quad \text{for } t \geq \alpha,$$

and let

$$F = \{t \mid \alpha \leq t \leq \beta \text{ and finitely many sets from } \mathcal{H} \text{ cover } S_t\}.$$

Since  $S_\beta = S$ , the theorem will be proved if we can show that  $\beta \in F$ . To do this, we use the completeness of the reals.

Since  $\alpha \in S$ ,  $S_\alpha$  is the singleton set  $\{\alpha\}$ , which is contained in some open set  $H_\alpha$  from  $\mathcal{H}$  because  $\mathcal{H}$  covers  $S$ ; therefore,  $\alpha \in F$ . Since  $F$  is nonempty and bounded above by  $\beta$ , it has a supremum  $\gamma$ . First, we wish to show that  $\gamma = \beta$ . Since  $\gamma \leq \beta$  by definition of  $F$ , it suffices to rule out the possibility that  $\gamma < \beta$ . We consider two cases.

CASE 1. Suppose that  $\gamma < \beta$  and  $\gamma \notin S$ . Then, since  $S$  is closed,  $\gamma$  is not a limit point of  $S$  (Theorem 1.3.5). Consequently, there is an  $\epsilon > 0$  such that

$$[\gamma - \epsilon, \gamma + \epsilon] \cap S = \emptyset,$$

so  $S_{\gamma-\epsilon} = S_{\gamma+\epsilon}$ . However, the definition of  $\gamma$  implies that  $S_{\gamma-\epsilon}$  has a finite subcovering from  $\mathcal{H}$ , while  $S_{\gamma+\epsilon}$  does not. This is a contradiction.

CASE 2. Suppose that  $\gamma < \beta$  and  $\gamma \in S$ . Then there is an open set  $H_\gamma$  in  $\mathcal{H}$  that contains  $\gamma$  and, along with  $\gamma$ , an interval  $[\gamma - \epsilon, \gamma + \epsilon]$  for some positive  $\epsilon$ . Since  $S_{\gamma-\epsilon}$  has a finite covering  $\{H_1, \dots, H_n\}$  of sets from  $\mathcal{H}$ , it follows that  $S_{\gamma+\epsilon}$  has the finite covering  $\{H_1, \dots, H_n, H_\gamma\}$ . This contradicts the definition of  $\gamma$ .

Now we know that  $\gamma = \beta$ , which is in  $S$ . Therefore, there is an open set  $H_\beta$  in  $\mathcal{H}$  that contains  $\beta$  and along with  $\beta$ , an interval of the form  $[\beta - \epsilon, \beta + \epsilon]$ , for some positive  $\epsilon$ . Since  $S_{\beta-\epsilon}$  is covered by a finite collection of sets  $\{H_1, \dots, H_k\}$ ,  $S_\beta$  is covered by the finite collection  $\{H_1, \dots, H_k, H_\beta\}$ . Since  $S_\beta = S$ , we are finished. ■

Henceforth, we will say that a closed and bounded set is *compact*. The Heine–Borel theorem says that any open covering of a compact set  $S$  contains a finite collection that also covers  $S$ . This theorem and its converse (Exercise 1.3.21) show that we could just as well define a set  $S$  of reals to be compact if it has the Heine–Borel property; that is, if every open covering of  $S$  contains a finite subcovering. The same is true of  $\mathbb{R}^n$ , which we study in Section 5.1. This definition generalizes to more abstract spaces (called *topological spaces*) for which the concept of boundedness need not be defined.

**Example 1.3.11** Since  $S_1$  in Example 1.3.10 is compact, the Heine–Borel theorem implies that  $S_1$  can be covered by a finite number of intervals from  $\mathcal{H}_1$ . This is easily verified, since, for example, the  $2N$  intervals from  $\mathcal{H}_1$  centered at the points  $x_k = k/2N$  ( $0 \leq k \leq 2N - 1$ ) cover  $S_1$ .

The Heine–Borel theorem does not apply to the other sets in Example 1.3.10 since they are not compact:  $S_2$  is unbounded and  $S_3$  and  $S_4$  are not closed, since they do not contain all their limit points (Corollary 1.3.6). The conclusion of the Heine–Borel theorem does not hold for these sets and the open coverings that we have given for them. Each point in  $S_2$  is contained in exactly one set from  $\mathcal{H}_2$ , so removing even one of these sets leaves a point of  $S_2$  uncovered. If  $\tilde{\mathcal{H}}_3$  is any finite collection of sets from  $\mathcal{H}_3$ , then

$$\frac{1}{n} \notin \bigcup \{H \mid H \in \tilde{\mathcal{H}}_3\}$$

for  $n$  sufficiently large. Any finite collection  $\{(0, \rho_1), \dots, (0, \rho_n)\}$  from  $\mathcal{H}_4$  covers only the interval  $(0, \rho_{\max})$ , where

$$\rho_{\max} = \max\{\rho_1, \dots, \rho_n\} < 1.$$

## The Bolzano–Weierstrass Theorem

As an application of the Heine–Borel theorem, we prove the following theorem of Bolzano and Weierstrass.

**Theorem 1.3.8 (Bolzano–Weierstrass Theorem)** *Every bounded infinite set of real numbers has at least one limit point.*

**Proof** We will show that a bounded nonempty set without a limit point can contain only a finite number of points. If  $S$  has no limit points, then  $S$  is closed (Theorem 1.3.5) and every point  $x$  of  $S$  has an open neighborhood  $N_x$  that contains no point of  $S$  other than  $x$ . The collection

$$\mathcal{H} = \{N_x \mid x \in S\}$$

is an open covering for  $S$ . Since  $S$  is also bounded, Theorem 1.3.7 implies that  $S$  can be covered by a finite collection of sets from  $\mathcal{H}$ , say  $N_{x_1}, \dots, N_{x_n}$ . Since these sets contain only  $x_1, \dots, x_n$  from  $S$ , it follows that  $S = \{x_1, \dots, x_n\}$ . ■

### 1.3 Exercises

- Find  $S \cap T$ ,  $(S \cap T)^c$ ,  $S^c \cap T^c$ ,  $S \cup T$ ,  $(S \cup T)^c$ , and  $S^c \cup T^c$ .  
 (a)  $S = (0, 1)$ ,  $T = [\frac{1}{2}, \frac{3}{2}]$     (b)  $S = \{x \mid x^2 > 4\}$ ,  $T = \{x \mid x^2 < 9\}$   
 (c)  $S = (-\infty, \infty)$ ,  $T = \emptyset$     (d)  $S = (-\infty, -1)$ ,  $T = (1, \infty)$
- Let  $S_k = (1 - 1/k, 2 + 1/k]$ ,  $k \geq 1$ . Find  
 (a)  $\bigcup_{k=1}^{\infty} S_k$     (b)  $\bigcap_{k=1}^{\infty} S_k$     (c)  $\bigcup_{k=1}^{\infty} S_k^c$     (d)  $\bigcap_{k=1}^{\infty} S_k^c$
- Prove: If  $A$  and  $B$  are sets and there is a set  $X$  such that  $A \cup X = B \cup X$  and  $A \cap X = B \cap X$ , then  $A = B$ .
- Find the largest  $\epsilon$  such that  $S$  contains an  $\epsilon$ -neighborhood of  $x_0$ .  
 (a)  $x_0 = \frac{3}{4}$ ,  $S = [\frac{1}{2}, 1)$     (b)  $x_0 = \frac{2}{3}$ ,  $S = [\frac{1}{2}, \frac{3}{2}]$   
 (c)  $x_0 = 5$ ,  $S = (-1, \infty)$     (d)  $x_0 = 1$ ,  $S = (0, 2)$
- Describe the following sets as open, closed, or neither, and find  $S^0$ ,  $(S^c)^0$ , and  $(S^0)^c$ .  
 (a)  $S = (-1, 2) \cup [3, \infty)$     (b)  $S = (-\infty, 1) \cup (2, \infty)$   
 (c)  $S = [-3, -2] \cup [7, 8]$     (d)  $S = \{x \mid x = \text{integer}\}$
- Prove that  $(S \cap T)^c = S^c \cup T^c$  and  $(S \cup T)^c = S^c \cap T^c$ .
- Let  $\mathcal{F}$  be a collection of sets and define

$$I = \bigcap \{F \mid F \in \mathcal{F}\} \quad \text{and} \quad U = \bigcup \{F \mid F \in \mathcal{F}\}.$$

Prove that (a)  $I^c = \bigcup \{F^c \mid F \in \mathcal{F}\}$  and (b)  $U^c = \{\bigcap F^c \mid F \in \mathcal{F}\}$ .

- (a) Show that the intersection of finitely many open sets is open.

- (b) Give an example showing that the intersection of infinitely many open sets may fail to be open.
9. (a) Show that the union of finitely many closed sets is closed.  
 (b) Give an example showing that the union of infinitely many closed sets may fail to be closed.
10. Prove:  
 (a) If  $U$  is a neighborhood of  $x_0$  and  $U \subset V$ , then  $V$  is a neighborhood of  $x_0$ .  
 (b) If  $U_1, \dots, U_n$  are neighborhoods of  $x_0$ , so is  $\bigcap_{i=1}^n U_i$ .
11. Find the set of limit points of  $S$ ,  $\partial S$ ,  $\overline{S}$ , the set of isolated points of  $S$ , and the exterior of  $S$ .  
 (a)  $S = (-\infty, -2) \cup (2, 3) \cup \{4\} \cup (7, \infty)$   
 (b)  $S = \{\text{all integers}\}$   
 (c)  $S = \cup \{(n, n+1) \mid n = \text{integer}\}$   
 (d)  $S = \{x \mid x = 1/n, n = 1, 2, 3, \dots\}$
12. Prove: A limit point of a set  $S$  is either an interior point or a boundary point of  $S$ .
13. Prove: An isolated point of  $S$  is a boundary point of  $S^c$ .
14. Prove:  
 (a) A boundary point of a set  $S$  is either a limit point or an isolated point of  $S$ .  
 (b) A set  $S$  is closed if and only if  $S = \overline{S}$ .
15. Prove or disprove: A set has no limit points if and only if each of its points is isolated.
16. (a) Prove: If  $S$  is bounded above and  $\beta = \sup S$ , then  $\beta \in \partial S$ .  
 (b) State the analogous result for a set bounded below.
17. Prove: If  $S$  is closed and bounded, then  $\inf S$  and  $\sup S$  are both in  $S$ .
18. If a nonempty subset  $S$  of  $\mathbb{R}$  is both open and closed, then  $S = \mathbb{R}$ .
19. Let  $S$  be an arbitrary set. Prove: (a)  $\partial S$  is closed. (b)  $S^0$  is open. (c) The exterior of  $S$  is open. (d) The limit points of  $S$  form a closed set. (e)  $\overline{(\overline{S})} = \overline{S}$ .
20. Give counterexamples to the following false statements.  
 (a) The isolated points of a set form a closed set.  
 (b) Every open set contains at least two points.  
 (c) If  $S_1$  and  $S_2$  are arbitrary sets, then  $\partial(S_1 \cup S_2) = \partial S_1 \cup \partial S_2$ .  
 (d) If  $S_1$  and  $S_2$  are arbitrary sets, then  $\partial(S_1 \cap S_2) = \partial S_1 \cap \partial S_2$ .  
 (e) The supremum of a bounded nonempty set is the greatest of its limit points.  
 (f) If  $S$  is any set, then  $\partial(\partial S) = \partial S$ .  
 (g) If  $S$  is any set, then  $\partial \overline{S} = \partial S$ .  
 (h) If  $S_1$  and  $S_2$  are arbitrary sets, then  $(S_1 \cup S_2)^0 = S_1^0 \cup S_2^0$ .

- 21.** Let  $S$  be a nonempty subset of  $\mathbb{R}$  such that if  $\mathcal{H}$  is any open covering of  $S$ , then  $S$  has an open covering  $\widetilde{\mathcal{H}}$  comprised of finitely many open sets from  $\mathcal{H}$ . Show that  $S$  is compact.
- 22.** A set  $S$  is dense in a set  $T$  if  $S \subset T \subset \overline{S}$ .
- (a) Prove: If  $S$  and  $T$  are sets of real numbers and  $S \subset T$ , then  $S$  is dense in  $T$  if and only if every neighborhood of each point in  $T$  contains a point from  $S$ .
- (b) State how (a) shows that the definition given here is consistent with the restricted definition of a dense subset of the reals given in Section 1.1.
- 23.** Prove:
- (a)  $(S_1 \cap S_2)^0 = S_1^0 \cap S_2^0$                       (b)  $S_1^0 \cup S_2^0 \subset (S_1 \cup S_2)^0$
- 24.** Prove:
- (a)  $\partial(S_1 \cup S_2) \subset \partial S_1 \cup \partial S_2$                       (b)  $\partial(S_1 \cap S_2) \subset \partial S_1 \cup \partial S_2$
- (c)  $\partial \overline{S} \subset \partial S$     (d)  $\partial S = \partial S^c$
- (e)  $\partial(S - T) \subset \partial S \cup \partial T$

## CHAPTER 2

### Differential Calculus of Functions of One Variable

IN THIS CHAPTER we study the differential calculus of functions of one variable.

SECTION 2.1 introduces the concept of function and discusses arithmetic operations on functions, limits, one-sided limits, limits at  $\pm\infty$ , and monotonic functions.

SECTION 2.2 defines continuity and discusses removable discontinuities, composite functions, bounded functions, the intermediate value theorem, uniform continuity, and additional properties of monotonic functions.

SECTION 2.3 introduces the derivative and its geometric interpretation. Topics covered include the interchange of differentiation and arithmetic operations, the chain rule, one-sided derivatives, extreme values of a differentiable function, Rolle's theorem, the intermediate value theorem for derivatives, and the mean value theorem and its consequences.

SECTION 2.4 presents a comprehensive discussion of L'Hospital's rule.

SECTION 2.5 discusses the approximation of a function  $f$  by the Taylor polynomials of  $f$  and applies this result to locating local extrema of  $f$ . The section concludes with the extended mean value theorem, which implies Taylor's theorem.

#### 2.1 FUNCTIONS AND LIMITS

In this section we study limits of real-valued functions of a real variable. You studied limits in calculus. However, we will look more carefully at the definition of limit and prove theorems usually not proved in calculus.

A rule  $f$  that assigns to each member of a nonempty set  $D$  a unique member of a set  $Y$  is a *function from  $D$  to  $Y$* . We write the relationship between a member  $x$  of  $D$  and the member  $y$  of  $Y$  that  $f$  assigns to  $x$  as

$$y = f(x).$$

The set  $D$  is the *domain* of  $f$ , denoted by  $D_f$ . The members of  $Y$  are the possible *values* of  $f$ . If  $y_0 \in Y$  and there is an  $x_0$  in  $D$  such that  $f(x_0) = y_0$  then we say that  $f$  *attains*

or assumes the value  $y_0$ . The set of values attained by  $f$  is the *range* of  $f$ . A *real-valued function of a real variable* is a function whose domain and range are both subsets of the reals. Although we are concerned only with real-valued functions of a real variable in this section, our definitions are not restricted to this situation. In later sections we will consider situations where the range or domain, or both, are subsets of vector spaces.

**Example 2.1.1** The functions  $f$ ,  $g$ , and  $h$  defined on  $(-\infty, \infty)$  by

$$f(x) = x^2, \quad g(x) = \sin x, \quad \text{and} \quad h(x) = e^x$$

have ranges  $[0, \infty)$ ,  $[-1, 1]$ , and  $(0, \infty)$ , respectively.

**Example 2.1.2** The equation

$$[f(x)]^2 = x \tag{2.1.1}$$

does not define a function except on the singleton set  $\{0\}$ . If  $x < 0$ , no real number satisfies (2.1.1), while if  $x > 0$ , two real numbers satisfy (2.1.1). However, the conditions

$$[f(x)]^2 = x \quad \text{and} \quad f(x) \geq 0$$

define a function  $f$  on  $D_f = [0, \infty)$  with values  $f(x) = \sqrt{x}$ . Similarly, the conditions

$$[g(x)]^2 = x \quad \text{and} \quad g(x) \leq 0$$

define a function  $g$  on  $D_g = [0, \infty)$  with values  $g(x) = -\sqrt{x}$ . The ranges of  $f$  and  $g$  are  $[0, \infty)$  and  $(-\infty, 0]$ , respectively. ■

It is important to understand that the definition of a function includes the specification of its domain and that there is a difference between  $f$ , the *name* of the function, and  $f(x)$ , the *value* of  $f$  at  $x$ . However, strict observance of these points leads to annoying verbosity, such as “the function  $f$  with domain  $(-\infty, \infty)$  and values  $f(x) = x$ .” We will avoid this in two ways: (1) by agreeing that if a function  $f$  is introduced without explicitly defining  $D_f$ , then  $D_f$  will be understood to consist of all points  $x$  for which the rule defining  $f(x)$  makes sense, and (2) by bearing in mind the distinction between  $f$  and  $f(x)$ , but not emphasizing it when it would be a nuisance to do so. For example, we will write “consider the function  $f(x) = \sqrt{1 - x^2}$ ,” rather than “consider the function  $f$  defined on  $[-1, 1]$  by  $f(x) = \sqrt{1 - x^2}$ ,” or “consider the function  $g(x) = 1/\sin x$ ,” rather than “consider the function  $g$  defined for  $x \neq k\pi$  ( $k = \text{integer}$ ) by  $g(x) = 1/\sin x$ .” We will also write  $f = c$  (constant) to denote the function  $f$  defined by  $f(x) = c$  for all  $x$ .

Our definition of function is somewhat intuitive, but adequate for our purposes. Moreover, it is the working form of the definition, even if the idea is introduced more rigorously to begin with. For a more precise definition, we first define the *Cartesian product*  $X \times Y$  of two nonempty sets  $X$  and  $Y$  to be the set of all ordered pairs  $(x, y)$  such that  $x \in X$  and  $y \in Y$ ; thus,

$$X \times Y = \{(x, y) \mid x \in X, y \in Y\}.$$

A nonempty subset  $f$  of  $X \times Y$  is a *function* if no  $x$  in  $X$  occurs more than once as a first member among the elements of  $f$ . Put another way, if  $(x, y)$  and  $(x, y_1)$  are in  $f$ , then  $y = y_1$ . The set of  $x$ 's that occur as first members of  $f$  is the *domain* of  $f$ . If  $x$  is in the domain of  $f$ , then the unique  $y$  in  $Y$  such that  $(x, y) \in f$  is the *value of  $f$  at  $x$* , and we write  $y = f(x)$ . The set of all such values, a subset of  $Y$ , is the *range of  $f$* .

### Arithmetic Operations on Functions

**Definition 2.1.1** If  $D_f \cap D_g \neq \emptyset$ , then  $f + g$ ,  $f - g$ , and  $fg$  are defined on  $D_f \cap D_g$  by

$$\begin{aligned}(f + g)(x) &= f(x) + g(x), \\ (f - g)(x) &= f(x) - g(x),\end{aligned}$$

and

$$(fg)(x) = f(x)g(x).$$

The quotient  $f/g$  is defined by

$$\left(\frac{f}{g}\right)(x) = \frac{f(x)}{g(x)}$$

for  $x$  in  $D_f \cap D_g$  such that  $g(x) \neq 0$ .

**Example 2.1.3** If  $f(x) = \sqrt{4-x^2}$  and  $g(x) = \sqrt{x-1}$ , then  $D_f = [-2, 2]$  and  $D_g = [1, \infty)$ , so  $f + g$ ,  $f - g$ , and  $fg$  are defined on  $D_f \cap D_g = [1, 2]$  by

$$\begin{aligned}(f + g)(x) &= \sqrt{4-x^2} + \sqrt{x-1}, \\ (f - g)(x) &= \sqrt{4-x^2} - \sqrt{x-1},\end{aligned}$$

and

$$(fg)(x) = (\sqrt{4-x^2})(\sqrt{x-1}) = \sqrt{(4-x^2)(x-1)}. \quad (2.1.2)$$

The quotient  $f/g$  is defined on  $(1, 2]$  by

$$\left(\frac{f}{g}\right)(x) = \sqrt{\frac{4-x^2}{x-1}}.$$

Although the last expression in (2.1.2) is also defined for  $-\infty < x < -2$ , it does not represent  $fg$  for such  $x$ , since  $f$  and  $g$  are not defined on  $(-\infty, -2]$ .

**Example 2.1.4** If  $c$  is a real number, the function  $cf$  defined by  $(cf)(x) = cf(x)$  can be regarded as the product of  $f$  and a constant function. Its domain is  $D_f$ . The sum and product of  $n$  ( $\geq 2$ ) functions  $f_1, \dots, f_n$  are defined by

$$(f_1 + f_2 + \dots + f_n)(x) = f_1(x) + f_2(x) + \dots + f_n(x)$$



and

$$(f_1 f_2 \cdots f_n)(x) = f_1(x) f_2(x) \cdots f_n(x) \quad (2.1.3)$$

on  $D = \bigcap_{i=1}^n D_{f_i}$ , provided that  $D$  is nonempty. If  $f_1 = f_2 = \cdots = f_n$ , then (2.1.3) defines the  $n$ th power of  $f$ :

$$(f^n)(x) = (f(x))^n.$$

From these definitions, we can build the set of all *polynomials*

$$p(x) = a_0 + a_1x + \cdots + a_nx^n,$$

starting from the constant functions and  $f(x) = x$ . The quotient of two polynomials is a *rational function*

$$r(x) = \frac{a_0 + a_1x + \cdots + a_nx^n}{b_0 + b_1x + \cdots + b_mx^m} \quad (b_m \neq 0).$$

The domain of  $r$  is the set of points where the denominator is nonzero.

## Limits

The essence of the concept of limit for real-valued functions of a real variable is this: If  $L$  is a real number, then  $\lim_{x \rightarrow x_0} f(x) = L$  means that the value  $f(x)$  can be made as close to  $L$  as we wish by taking  $x$  sufficiently close to  $x_0$ . This is made precise in the following definition.

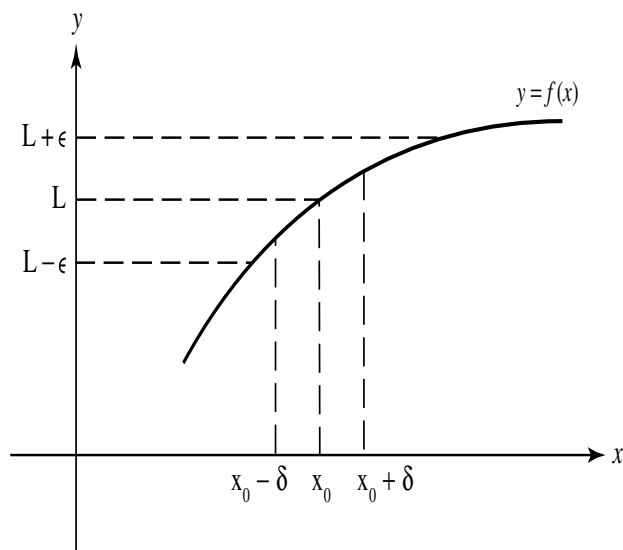


Figure 2.1.1

**Definition 2.1.2** We say that  $f(x)$  approaches the limit  $L$  as  $x$  approaches  $x_0$ , and write

$$\lim_{x \rightarrow x_0} f(x) = L,$$

if  $f$  is defined on some deleted neighborhood of  $x_0$  and, for every  $\epsilon > 0$ , there is a  $\delta > 0$  such that

$$|f(x) - L| < \epsilon \quad (2.1.4)$$

if

$$0 < |x - x_0| < \delta. \quad (2.1.5)$$

Figure 2.1.1 depicts the graph of a function for which  $\lim_{x \rightarrow x_0} f(x)$  exists.

**Example 2.1.5** If  $c$  and  $x$  are arbitrary real numbers and  $f(x) = cx$ , then

$$\lim_{x \rightarrow x_0} f(x) = cx_0.$$

To prove this, we write

$$|f(x) - cx_0| = |cx - cx_0| = |c||x - x_0|.$$

If  $c \neq 0$ , this yields

$$|f(x) - cx_0| < \epsilon \quad (2.1.6)$$

if

$$|x - x_0| < \delta,$$

where  $\delta$  is any number such that  $0 < \delta \leq \epsilon/|c|$ . If  $c = 0$ , then  $f(x) - cx_0 = 0$  for all  $x$ , so (2.1.6) holds for all  $x$ . ■

We emphasize that Definition 2.1.2 does not involve  $f(x_0)$ , or even require that it be defined, since (2.1.5) excludes the case where  $x = x_0$ .

**Example 2.1.6** If

$$f(x) = x \sin \frac{1}{x}, \quad x \neq 0,$$

then

$$\lim_{x \rightarrow 0} f(x) = 0$$

even though  $f$  is not defined at  $x_0 = 0$ , because if

$$0 < |x| < \delta = \epsilon,$$

then

$$|f(x) - 0| = \left| x \sin \frac{1}{x} \right| \leq |x| < \epsilon.$$

On the other hand, the function

$$g(x) = \sin \frac{1}{x}, \quad x \neq 0,$$

has no limit as  $x$  approaches 0, since it assumes all values between  $-1$  and  $1$  in every neighborhood of the origin (Exercise 2.1.26). ■

The next theorem says that a function cannot have more than one limit at a point.

**Theorem 2.1.3** *If  $\lim_{x \rightarrow x_0} f(x)$  exists, then it is unique; that is, if*

$$\lim_{x \rightarrow x_0} f(x) = L_1 \quad \text{and} \quad \lim_{x \rightarrow x_0} f(x) = L_2, \quad (2.1.7)$$

then  $L_1 = L_2$ .

**Proof** Suppose that (2.1.7) holds and let  $\epsilon > 0$ . From Definition 2.1.2, there are positive numbers  $\delta_1$  and  $\delta_2$  such that

$$|f(x) - L_i| < \epsilon \quad \text{if} \quad 0 < |x - x_0| < \delta_i, \quad i = 1, 2.$$

If  $\delta = \min(\delta_1, \delta_2)$ , then

$$\begin{aligned} |L_1 - L_2| &= |L_1 - f(x) + f(x) - L_2| \\ &\leq |L_1 - f(x)| + |f(x) - L_2| < 2\epsilon \quad \text{if} \quad 0 < |x - x_0| < \delta. \end{aligned}$$

We have now established an inequality that does not depend on  $x$ ; that is,

$$|L_1 - L_2| < 2\epsilon.$$

Since this holds for any positive  $\epsilon$ ,  $L_1 = L_2$ . ■

Definition 2.1.2 is not changed by replacing (2.1.4) with

$$|f(x) - L| < K\epsilon, \quad (2.1.8)$$

where  $K$  is a positive constant, because if either of (2.1.4) or (2.1.8) can be made to hold for any  $\epsilon > 0$  by making  $|x - x_0|$  sufficiently small and positive, then so can the other (Exercise 2.1.5). This may seem to be a minor point, but it is often convenient to work with (2.1.8) rather than (2.1.4), as we will see in the proof of the following theorem.

## A Useful Theorem about Limits

**Theorem 2.1.4** *If*

$$\lim_{x \rightarrow x_0} f(x) = L_1 \quad \text{and} \quad \lim_{x \rightarrow x_0} g(x) = L_2, \quad (2.1.9)$$

then

$$\lim_{x \rightarrow x_0} (f + g)(x) = L_1 + L_2, \quad (2.1.10)$$

$$\lim_{x \rightarrow x_0} (f - g)(x) = L_1 - L_2, \quad (2.1.11)$$

$$\lim_{x \rightarrow x_0} (fg)(x) = L_1 L_2, \quad (2.1.12)$$

and, if  $L_2 \neq 0$ , (2.1.13)

$$\lim_{x \rightarrow x_0} \left( \frac{f}{g} \right)(x) = \frac{L_1}{L_2}. \quad (2.1.14)$$

**Proof** From (2.1.9) and Definition 2.1.2, if  $\epsilon > 0$ , there is a  $\delta_1 > 0$  such that

$$|f(x) - L_1| < \epsilon \quad (2.1.15)$$

if  $0 < |x - x_0| < \delta_1$ , and a  $\delta_2 > 0$  such that

$$|g(x) - L_2| < \epsilon \quad (2.1.16)$$

if  $0 < |x - x_0| < \delta_2$ . Suppose that

$$0 < |x - x_0| < \delta = \min(\delta_1, \delta_2), \quad (2.1.17)$$

so that (2.1.15) and (2.1.16) both hold. Then

$$\begin{aligned} |(f \pm g)(x) - (L_1 \pm L_2)| &= |(f(x) - L_1) \pm (g(x) - L_2)| \\ &\leq |f(x) - L_1| + |g(x) - L_2| < 2\epsilon, \end{aligned}$$

which proves (2.1.10) and (2.1.11).

To prove (2.1.12), we assume (2.1.17) and write

$$\begin{aligned} |(fg)(x) - L_1L_2| &= |f(x)g(x) - L_1L_2| \\ &= |f(x)(g(x) - L_2) + L_2(f(x) - L_1)| \\ &\leq |f(x)||g(x) - L_2| + |L_2||f(x) - L_1| \\ &\leq (|f(x)| + |L_2|)\epsilon \quad (\text{from (2.1.15) and (2.1.16)}) \\ &\leq (|f(x) - L_1| + |L_1| + |L_2|)\epsilon \\ &\leq (\epsilon + |L_1| + |L_2|)\epsilon \quad \text{from (2.1.15)} \\ &\leq (1 + |L_1| + |L_2|)\epsilon \end{aligned}$$

if  $\epsilon < 1$  and  $x$  satisfies (2.1.17). This proves (2.1.12).

To prove (2.1.14), we first observe that if  $L_2 \neq 0$ , there is a  $\delta_3 > 0$  such that

$$|g(x) - L_2| < \frac{|L_2|}{2},$$

so

$$|g(x)| > \frac{|L_2|}{2} \quad (2.1.18)$$

if

$$0 < |x - x_0| < \delta_3.$$

To see this, let  $L = L_2$  and  $\epsilon = |L_2|/2$  in (2.1.4). Now suppose that

$$0 < |x - x_0| < \min(\delta_1, \delta_2, \delta_3),$$

so that (2.1.15), (2.1.16), and (2.1.18) all hold. Then

$$\begin{aligned}
\left| \left( \frac{f}{g} \right) (x) - \frac{L_1}{L_2} \right| &= \left| \frac{f(x)}{g(x)} - \frac{L_1}{L_2} \right| \\
&= \frac{|L_2 f(x) - L_1 g(x)|}{|g(x) L_2|} \\
&\leq \frac{2}{|L_2|^2} |L_2 f(x) - L_1 g(x)| \\
&= \frac{2}{|L_2|^2} |L_2 [f(x) - L_1] + L_1 [L_2 - g(x)]| \quad (\text{from (2.1.18)}) \\
&\leq \frac{2}{|L_2|^2} [|L_2| |f(x) - L_1| + |L_1| |L_2 - g(x)|] \\
&\leq \frac{2}{|L_2|^2} (|L_2| + |L_1|) \epsilon \quad (\text{from (2.1.15) and (2.1.16)}).
\end{aligned}$$

This proves (2.1.14). ■

Successive applications of the various parts of Theorem 2.1.4 permit us to find limits without the  $\epsilon$ - $\delta$  arguments required by Definition 2.1.2.

**Example 2.1.7** Use Theorem 2.1.4 to find

$$\lim_{x \rightarrow 2} \frac{9 - x^2}{x + 1} \quad \text{and} \quad \lim_{x \rightarrow 2} (9 - x^2)(x + 1).$$

**Solution** If  $c$  is a constant, then  $\lim_{x \rightarrow x_0} c = c$ , and, from Example 2.1.5,  $\lim_{x \rightarrow x_0} x = x_0$ . Therefore, from Theorem 2.1.4,

$$\begin{aligned}
\lim_{x \rightarrow 2} (9 - x^2) &= \lim_{x \rightarrow 2} 9 - \lim_{x \rightarrow 2} x^2 \\
&= \lim_{x \rightarrow 2} 9 - (\lim_{x \rightarrow 2} x)^2 \\
&= 9 - 2^2 = 5,
\end{aligned}$$

and

$$\lim_{x \rightarrow 2} (x + 1) = \lim_{x \rightarrow 2} x + \lim_{x \rightarrow 2} 1 = 2 + 1 = 3.$$

Therefore,

$$\lim_{x \rightarrow 2} \frac{9 - x^2}{x + 1} = \frac{\lim_{x \rightarrow 2} (9 - x^2)}{\lim_{x \rightarrow 2} (x + 1)} = \frac{5}{3}$$

and

$$\lim_{x \rightarrow 2} (9 - x^2)(x + 1) = \lim_{x \rightarrow 2} (9 - x^2) \lim_{x \rightarrow 2} (x + 1) = 5 \cdot 3 = 15. \quad \blacksquare$$

## One-Sided Limits

The function

$$f(x) = 2x \sin \sqrt{x}$$

satisfies the inequality

$$|f(x)| < \epsilon$$

if  $0 < x < \delta = \epsilon/2$ . However, this does not mean that  $\lim_{x \rightarrow 0} f(x) = 0$ , since  $f$  is not defined for negative  $x$ , as it must be to satisfy the conditions of Definition 2.1.2 with  $x_0 = 0$  and  $L = 0$ . The function

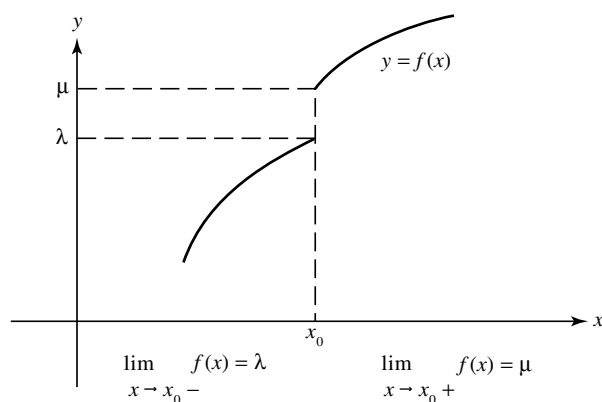
$$g(x) = x + \frac{|x|}{x}, \quad x \neq 0,$$

can be rewritten as

$$g(x) = \begin{cases} x + 1, & x > 0, \\ x - 1, & x < 0; \end{cases}$$

hence, every open interval containing  $x_0 = 0$  also contains points  $x_1$  and  $x_2$  such that  $|g(x_1) - g(x_2)|$  is as close to 2 as we please. Therefore,  $\lim_{x \rightarrow x_0} g(x)$  does not exist (Exercise 2.1.26).

Although  $f(x)$  and  $g(x)$  do not approach limits as  $x$  approaches zero, they each exhibit a definite sort of limiting behavior for small positive values of  $x$ , as does  $g(x)$  for small negative values of  $x$ . The kind of behavior we have in mind is defined precisely as follows.



**Figure 2.1.2**

### Definition 2.1.5

(a) We say that  $f(x)$  approaches the left-hand limit  $L$  as  $x$  approaches  $x_0$  from the left, and write

$$\lim_{x \rightarrow x_0^-} f(x) = L,$$

if  $f$  is defined on some open interval  $(a, x_0)$  and, for each  $\epsilon > 0$ , there is a  $\delta > 0$  such that

$$|f(x) - L| < \epsilon \quad \text{if} \quad x_0 - \delta < x < x_0.$$

(b) We say that  $f(x)$  approaches the right-hand limit  $L$  as  $x$  approaches  $x_0$  from the right, and write

$$\lim_{x \rightarrow x_0^+} f(x) = L,$$

if  $f$  is defined on some open interval  $(x_0, b)$  and, for each  $\epsilon > 0$ , there is a  $\delta > 0$  such that

$$|f(x) - L| < \epsilon \quad \text{if} \quad x_0 < x < x_0 + \delta. \quad \blacksquare$$

Figure 2.1.2 shows the graph of a function that has distinct left- and right-hand limits at a point  $x_0$ .

**Example 2.1.8** Let

$$f(x) = \frac{x}{|x|}, \quad x \neq 0.$$

If  $x < 0$ , then  $f(x) = -x/x = -1$ , so

$$\lim_{x \rightarrow 0^-} f(x) = -1.$$

If  $x > 0$ , then  $f(x) = x/x = 1$ , so

$$\lim_{x \rightarrow 0^+} f(x) = 1.$$

**Example 2.1.9** Let

$$g(x) = \frac{x + |x|(1 + x)}{x} \sin \frac{1}{x}, \quad x \neq 0.$$

If  $x < 0$ , then

$$g(x) = -x \sin \frac{1}{x},$$

so

$$\lim_{x \rightarrow 0^-} g(x) = 0,$$

since

$$|g(x) - 0| = \left| x \sin \frac{1}{x} \right| \leq |x| < \epsilon$$

if  $-\epsilon < x < 0$ ; that is, Definition 2.1.5(a) is satisfied with  $\delta = \epsilon$ . If  $x > 0$ , then

$$g(x) = (2 + x) \sin \frac{1}{x},$$

which takes on every value between  $-2$  and  $2$  in every interval  $(0, \delta)$ . Hence,  $g(x)$  does not approach a right-hand limit as  $x$  approaches  $0$  from the right. This shows that a function may have a limit from one side at a point but fail to have a limit from the other side.

**Example 2.1.10** We leave it to you to verify that

$$\begin{aligned}\lim_{x \rightarrow 0^+} \left( \frac{|x|}{x} + x \right) &= 1, \\ \lim_{x \rightarrow 0^-} \left( \frac{|x|}{x} + x \right) &= -1, \\ \lim_{x \rightarrow 0^+} x \sin \sqrt{x} &= 0,\end{aligned}$$

and  $\lim_{x \rightarrow 0^-} \sin \sqrt{x}$  does not exist. ■

Left- and right-hand limits are also called *one-sided limits*. We will often simplify the notation by writing

$$\lim_{x \rightarrow x_0^-} f(x) = f(x_0^-) \quad \text{and} \quad \lim_{x \rightarrow x_0^+} f(x) = f(x_0^+).$$

The following theorem states the connection between limits and one-sided limits. We leave the proof to you (Exercise 2.1.12).

**Theorem 2.1.6** *A function  $f$  has a limit at  $x_0$  if and only if it has left- and right-hand limits at  $x_0$ , and they are equal. More specifically,*

$$\lim_{x \rightarrow x_0} f(x) = L$$

*if and only if*

$$f(x_0^+) = f(x_0^-) = L.$$

With only minor modifications of their proofs (replacing the inequality  $0 < |x - x_0| < \delta$  by  $x_0 - \delta < x < x_0$  or  $x_0 < x < x_0 + \delta$ ), it can be shown that the assertions of Theorems 2.1.3 and 2.1.4 remain valid if “ $\lim_{x \rightarrow x_0}$ ” is replaced by “ $\lim_{x \rightarrow x_0^-}$ ” or “ $\lim_{x \rightarrow x_0^+}$ ” throughout (Exercise 2.1.13).

### Limits at $\pm\infty$

Limits and one-sided limits have to do with the behavior of a function  $f$  near a limit point of  $D_f$ . It is equally reasonable to study  $f$  for large positive values of  $x$  if  $D_f$  is unbounded above or for large negative values of  $x$  if  $D_f$  is unbounded below.

**Definition 2.1.7** We say that  $f(x)$  approaches the limit  $L$  as  $x$  approaches  $\infty$ , and write

$$\lim_{x \rightarrow \infty} f(x) = L,$$

if  $f$  is defined on an interval  $(a, \infty)$  and, for each  $\epsilon > 0$ , there is a number  $\beta$  such that

$$|f(x) - L| < \epsilon \quad \text{if} \quad x > \beta. \quad \blacksquare$$



Figure 2.1.3 provides an illustration of the situation described in Definition 2.1.7.

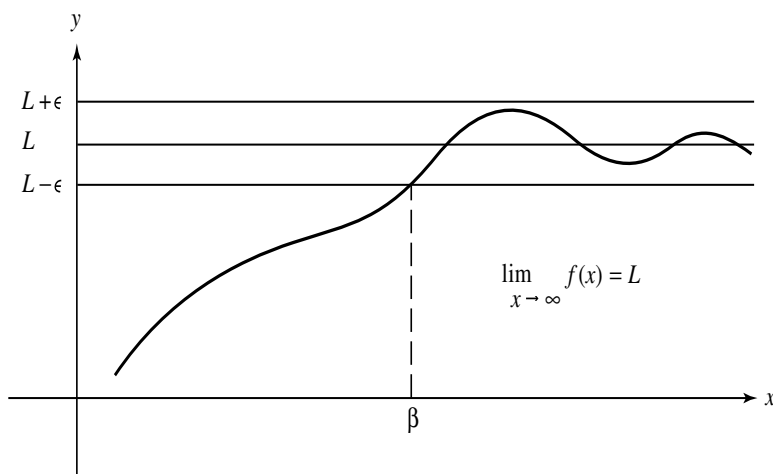


Figure 2.1.3

We leave it to you to define the statement “ $\lim_{x \rightarrow -\infty} f(x) = L$ ” (Exercise 2.1.14) and to show that Theorems 2.1.3 and 2.1.4 remain valid if  $x_0$  is replaced throughout by  $\infty$  or  $-\infty$  (Exercise 2.1.16).

**Example 2.1.11** Let

$$f(x) = 1 - \frac{1}{x^2}, \quad g(x) = \frac{2|x|}{1+x}, \quad \text{and} \quad h(x) = \sin x.$$

Then

$$\lim_{x \rightarrow \infty} f(x) = 1,$$

since

$$|f(x) - 1| = \frac{1}{x^2} < \epsilon \quad \text{if} \quad x > \frac{1}{\sqrt{\epsilon}},$$

and

$$\lim_{x \rightarrow \infty} g(x) = 2,$$

since

$$|g(x) - 2| = \left| \frac{2x}{1+x} - 2 \right| = \frac{2}{1+x} < \frac{2}{x} < \epsilon \quad \text{if} \quad x > \frac{2}{\epsilon}.$$

However,  $\lim_{x \rightarrow \infty} h(x)$  does not exist, since  $h$  assumes all values between  $-1$  and  $1$  in any semi-infinite interval  $(\tau, \infty)$ .

We leave it to you to show that  $\lim_{x \rightarrow -\infty} f(x) = 1$ ,  $\lim_{x \rightarrow -\infty} g(x) = -2$ , and  $\lim_{x \rightarrow -\infty} h(x)$  does not exist (Exercise 2.1.17). ■

We will sometimes denote  $\lim_{x \rightarrow \infty} f(x)$  and  $\lim_{x \rightarrow -\infty} f(x)$  by  $f(\infty)$  and  $f(-\infty)$ , respectively.

### Infinite Limits

The functions

$$f(x) = \frac{1}{x}, \quad g(x) = \frac{1}{x^2}, \quad p(x) = \sin \frac{1}{x},$$

and

$$q(x) = \frac{1}{x^2} \sin \frac{1}{x}$$

do not have limits, or even one-sided limits, at  $x_0 = 0$ . They fail to have limits in different ways:

- $f(x)$  increases beyond bound as  $x$  approaches 0 from the right and decreases beyond bound as  $x$  approaches 0 from the left;
- $g(x)$  increases beyond bound as  $x$  approaches zero;
- $p(x)$  oscillates with ever-increasing frequency as  $x$  approaches zero;
- $q(x)$  oscillates with ever-increasing amplitude and frequency as  $x$  approaches 0.

The kind of behavior exhibited by  $f$  and  $g$  near  $x_0 = 0$  is sufficiently common and simple to lead us to define *infinite limits*.

**Definition 2.1.8** We say that  $f(x)$  approaches  $\infty$  as  $x$  approaches  $x_0$  from the left, and write

$$\lim_{x \rightarrow x_0^-} f(x) = \infty \quad \text{or} \quad f(x_0^-) = \infty,$$

if  $f$  is defined on an interval  $(a, x_0)$  and, for each real number  $M$ , there is a  $\delta > 0$  such that

$$f(x) > M \quad \text{if} \quad x_0 - \delta < x < x_0.$$

**Example 2.1.12** We leave it to you to define the other kinds of infinite limits (Exercises 2.1.19 and 2.1.21) and show that

$$\begin{aligned} \lim_{x \rightarrow 0^-} \frac{1}{x} &= -\infty, & \lim_{x \rightarrow 0^+} \frac{1}{x} &= \infty; \\ \lim_{x \rightarrow 0^-} \frac{1}{x^2} &= \lim_{x \rightarrow 0^+} \frac{1}{x^2} = \lim_{x \rightarrow 0} \frac{1}{x^2} = \infty; \\ \lim_{x \rightarrow \infty} x^2 &= \lim_{x \rightarrow -\infty} x^2 = \infty; \end{aligned}$$

and

$$\lim_{x \rightarrow \infty} x^3 = \infty, \quad \lim_{x \rightarrow -\infty} x^3 = -\infty. \quad \blacksquare$$

Throughout this book, “ $\lim_{x \rightarrow x_0} f(x)$  exists” will mean that

$$\lim_{x \rightarrow x_0} f(x) = L, \quad \text{where } L \text{ is finite.}$$

To leave open the possibility that  $L = \pm\infty$ , we will say that

$$\lim_{x \rightarrow x_0} f(x) \text{ exists in the extended reals.}$$

This convention also applies to one-sided limits and limits as  $x$  approaches  $\pm\infty$ .

We mentioned earlier that Theorems 2.1.3 and 2.1.4 remain valid if “ $\lim_{x \rightarrow x_0}$ ” is replaced by “ $\lim_{x \rightarrow x_0^-}$ ” or “ $\lim_{x \rightarrow x_0^+}$ .” They are also valid with  $x_0$  replaced by  $\pm\infty$ . Moreover, the counterparts of (2.1.10), (2.1.11), and (2.1.12) in all these versions of Theorem 2.1.4 remain valid if either or both of  $L_1$  and  $L_2$  are infinite, provided that their right sides are not indeterminate (Exercises 2.1.28 and 2.1.29). Equation (2.1.14) and its counterparts remain valid if  $L_1/L_2$  is not indeterminate and  $L_2 \neq 0$  (Exercise 2.1.30).

**Example 2.1.13** Results like Theorem 2.1.4 yield

$$\begin{aligned} \lim_{x \rightarrow \infty} \sinh x &= \lim_{x \rightarrow \infty} \frac{e^x - e^{-x}}{2} = \frac{1}{2} \left( \lim_{x \rightarrow \infty} e^x - \lim_{x \rightarrow \infty} e^{-x} \right) \\ &= \frac{1}{2}(\infty - 0) = \infty, \\ \lim_{x \rightarrow -\infty} \sinh x &= \lim_{x \rightarrow -\infty} \frac{e^x - e^{-x}}{2} = \frac{1}{2} \left( \lim_{x \rightarrow -\infty} e^x - \lim_{x \rightarrow -\infty} e^{-x} \right) \\ &= \frac{1}{2}(0 - \infty) = -\infty, \end{aligned}$$

and

$$\lim_{x \rightarrow \infty} \frac{e^{-x}}{x} = \frac{\lim_{x \rightarrow \infty} e^{-x}}{\lim_{x \rightarrow \infty} x} = \frac{0}{\infty} = 0.$$

**Example 2.1.14** If

$$f(x) = e^{2x} - e^x,$$

we cannot obtain  $\lim_{x \rightarrow \infty} f(x)$  by writing

$$\lim_{x \rightarrow \infty} f(x) = \lim_{x \rightarrow \infty} e^{2x} - \lim_{x \rightarrow \infty} e^x,$$

because this produces the indeterminate form  $\infty - \infty$ . However, by writing

$$f(x) = e^{2x}(1 - e^{-x}),$$

we find that

$$\lim_{x \rightarrow \infty} f(x) = \left( \lim_{x \rightarrow \infty} e^{2x} \right) \left( \lim_{x \rightarrow \infty} 1 - \lim_{x \rightarrow \infty} e^{-x} \right) = \infty(1 - 0) = \infty.$$

**Example 2.1.15** Let

$$g(x) = \frac{2x^2 - x + 1}{3x^2 + 2x - 1}.$$

Trying to find  $\lim_{x \rightarrow \infty} g(x)$  by applying a version of Theorem 2.1.4 to this fraction as it is written leads to an indeterminate form (try it!). However, by rewriting it as

$$g(x) = \frac{2 - 1/x + 1/x^2}{3 + 2/x - 1/x^2}, \quad x \neq 0,$$

we find that

$$\lim_{x \rightarrow \infty} g(x) = \frac{\lim_{x \rightarrow \infty} 2 - \lim_{x \rightarrow \infty} 1/x + \lim_{x \rightarrow \infty} 1/x^2}{\lim_{x \rightarrow \infty} 3 + \lim_{x \rightarrow \infty} 2/x - \lim_{x \rightarrow \infty} 1/x^2} = \frac{2 - 0 + 0}{3 + 0 - 0} = \frac{2}{3}.$$

### Monotonic Function

A function  $f$  is *nondecreasing* on an interval  $I$  if

$$f(x_1) \leq f(x_2) \quad \text{whenever } x_1 \text{ and } x_2 \text{ are in } I \text{ and } x_1 < x_2, \quad (2.1.19)$$

or *nonincreasing* on  $I$  if

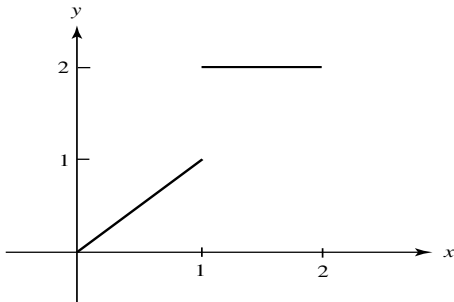
$$f(x_1) \geq f(x_2) \quad \text{whenever } x_1 \text{ and } x_2 \text{ are in } I \text{ and } x_1 < x_2. \quad (2.1.20)$$

In either case,  $f$  is *is* on  $I$ . If  $\leq$  can be replaced by  $<$  in (2.1.19),  $f$  is *increasing* on  $I$ . If  $\geq$  can be replaced by  $>$  in (2.1.20),  $f$  is *decreasing* on  $I$ . In either of these two cases,  $f$  is *strictly monotonic* on  $I$ .

**Example 2.1.16** The function

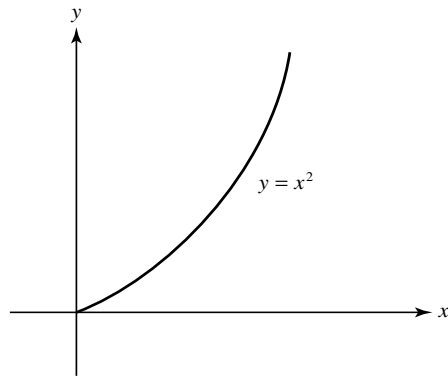
$$f(x) = \begin{cases} x, & 0 \leq x < 1, \\ 2, & 1 \leq x \leq 2, \end{cases}$$

is nondecreasing on  $I = [0, 2]$  (Figure 2.1.4), and  $-f$  is nonincreasing on  $I = [0, 2]$ .

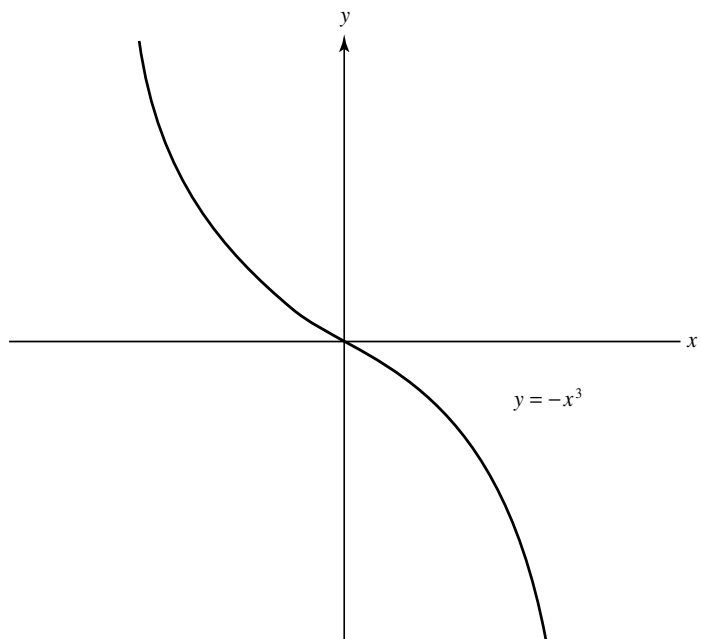


**Figure 2.1.4**

The function  $g(x) = x^2$  is increasing on  $[0, \infty)$  (Figure 2.1.5),

**Figure 2.1.5**

and  $h(x) = -x^3$  is decreasing on  $(-\infty, \infty)$  (Figure 2.1.6). ■

**Figure 2.1.6**

In the proof of the following theorem, we assume that you have formulated the definitions called for in Exercise 2.1.19.

**Theorem 2.1.9** Suppose that  $f$  is monotonic on  $(a, b)$  and define

$$\alpha = \inf_{a < x < b} f(x) \quad \text{and} \quad \beta = \sup_{a < x < b} f(x).$$

- (a) If  $f$  is nondecreasing, then  $f(a+) = \alpha$  and  $f(b-) = \beta$ .  
 (b) If  $f$  is nonincreasing, then  $f(a+) = \beta$  and  $f(b-) = \alpha$ .  
 (Here  $a+ = -\infty$  if  $a = -\infty$  and  $b- = \infty$  if  $b = \infty$ .)  
 (c) If  $a < x_0 < b$ , then  $f(x_0+)$  and  $f(x_0-)$  exist and are finite; moreover,

$$f(x_0-) \leq f(x_0) \leq f(x_0+)$$

if  $f$  is nondecreasing, and

$$f(x_0-) \geq f(x_0) \geq f(x_0+)$$

if  $f$  is nonincreasing.

**Proof** (a) We first show that  $f(a+) = \alpha$ . If

$M > \alpha$ , there is an  $x_0$  in  $(a, b)$  such that  $f(x_0) < M$ . Since  $f$  is nondecreasing,  $f(x) < M$  if  $a < x < x_0$ . Therefore, if  $\alpha = -\infty$ , then  $f(a+) = -\infty$ . If  $\alpha > -\infty$ , let  $M = \alpha + \epsilon$ , where  $\epsilon > 0$ . Then  $\alpha \leq f(x) < \alpha + \epsilon$ , so

$$|f(x) - \alpha| < \epsilon \quad \text{if} \quad a < x < x_0. \quad (2.1.21)$$

If  $a = -\infty$ , this implies that  $f(-\infty) = \alpha$ . If  $a > -\infty$ , let  $\delta = x_0 - a$ . Then (2.1.21) is equivalent to

$$|f(x) - \alpha| < \epsilon \quad \text{if} \quad a < x < a + \delta,$$

which implies that  $f(a+) = \alpha$ .

We now show that  $f(b-) = \beta$ . If  $M < \beta$ , there is an  $x_0$  in  $(a, b)$  such that  $f(x_0) > M$ . Since  $f$  is nondecreasing,  $f(x) > M$  if  $x_0 < x < b$ . Therefore, if  $\beta = \infty$ , then  $f(b-) = \infty$ . If  $\beta < \infty$ , let  $M = \beta - \epsilon$ , where  $\epsilon > 0$ . Then  $\beta - \epsilon < f(x) \leq \beta$ , so

$$|f(x) - \beta| < \epsilon \quad \text{if} \quad x_0 < x < b. \quad (2.1.22)$$

If  $b = \infty$ , this implies that  $f(\infty) = \beta$ . If  $b < \infty$ , let  $\delta = b - x_0$ . Then (2.1.22) is equivalent to

$$|f(x) - \beta| < \epsilon \quad \text{if} \quad b - \delta < x < b,$$

which implies that  $f(b-) = \beta$ .

(b) The proof is similar to the proof of (a) (Exercise 2.1.34).

(c) Suppose that  $f$  is nondecreasing. Applying (a) to  $f$  on  $(a, x_0)$  and  $(x_0, b)$  separately shows that

$$f(x_0-) = \sup_{a < x < x_0} f(x) \quad \text{and} \quad f(x_0+) = \inf_{x_0 < x < b} f(x).$$

However, if  $x_1 < x_0 < x_2$ , then

$$f(x_1) \leq f(x_0) \leq f(x_2);$$

hence,

$$f(x_{0-}) \leq f(x_0) \leq f(x_{0+}).$$

We leave the case where  $f$  is nonincreasing to you (Exercise 2.1.34). ■

### Limits Inferior and Superior

We now introduce some concepts related to limits. We leave the study of these concepts mainly to the exercises.

We say that  $f$  is *bounded* on a set  $S$  if there is a constant  $M < \infty$  such that  $|f(x)| \leq M$  for all  $x$  in  $S$ .

**Definition 2.1.10** Suppose that  $f$  is bounded on  $[a, x_0)$ , where  $x_0$  may be finite or  $\infty$ . For  $a \leq x < x_0$ , define

$$S_f(x; x_0) = \sup_{x \leq t < x_0} f(t)$$

and

$$I_f(x; x_0) = \inf_{x \leq t < x_0} f(t).$$

Then the *left limit superior of  $f$  at  $x_0$*  is defined to be

$$\overline{\lim}_{x \rightarrow x_0^-} f(x) = \lim_{x \rightarrow x_0^-} S_f(x; x_0),$$

and the *left limit inferior of  $f$  at  $x_0$*  is defined to be

$$\underline{\lim}_{x \rightarrow x_0^-} f(x) = \lim_{x \rightarrow x_0^-} I_f(x; x_0).$$

(If  $x_0 = \infty$ , we define  $x_{0-} = \infty$ .)

**Theorem 2.1.11** If  $f$  is bounded on  $[a, x_0)$ , then  $\beta = \overline{\lim}_{x \rightarrow x_0^-} f(x)$  exists and is the unique real number with the following properties:

(a) If  $\epsilon > 0$ , there is an  $a_1$  in  $[a, x_0)$  such that

$$f(x) < \beta + \epsilon \quad \text{if} \quad a_1 \leq x < x_0. \quad (2.1.23)$$

(b) If  $\epsilon > 0$  and  $a_1$  is in  $[a, x_0)$ , then

$$f(\bar{x}) > \beta - \epsilon \quad \text{for some} \quad \bar{x} \in [a_1, x_0).$$

**Proof** Since  $f$  is bounded on  $[a, x_0)$ ,  $S_f(x; x_0)$  is nonincreasing and bounded on  $[a, x_0)$ . By applying Theorem 2.1.9(b) to  $S_f(x; x_0)$ , we conclude that  $\beta$  exists (finite). Therefore, if  $\epsilon > 0$ , there is an  $\bar{a}$  in  $[a, x_0)$  such that

$$\beta - \epsilon/2 < S_f(x; x_0) < \beta + \epsilon/2 \quad \text{if} \quad \bar{a} \leq x < x_0. \quad (2.1.24)$$

Since  $S_f(x; x_0)$  is an upper bound of  $\{f(t) \mid x \leq t < x_0\}$ ,  $f(x) \leq S_f(x; x_0)$ . Therefore, the second inequality in (2.1.24) implies (2.1.23) with  $a_1 = \bar{a}$ . This proves (a). To prove (b), let  $a_1$  be given and define  $x_1 = \max(a_1, \bar{a})$ . Then the first inequality in (2.1.24) implies that

$$S_f(x_1; x_0) > \beta - \epsilon/2. \quad (2.1.25)$$

Since  $S_f(x_1; x_0)$  is the supremum of  $\{f(t) \mid x_1 < t < x_0\}$ , there is an  $\bar{x}$  in  $[x_1, x_0)$  such that

$$f(\bar{x}) > S_f(x_1; x_0) - \epsilon/2.$$

This and (2.1.25) imply that  $f(\bar{x}) > \beta - \epsilon$ . Since  $\bar{x}$  is in  $[a_1, x_0)$ , this proves (b).

Now we show that there cannot be more than one real number with properties (a) and (b). Suppose that  $\beta_1 < \beta_2$  and  $\beta_2$  has property (b); thus, if  $\epsilon > 0$  and  $a_1$  is in  $[a, x_0)$ , there is an  $\bar{x}$  in  $[a_1, x_0)$  such that  $f(\bar{x}) > \beta_2 - \epsilon$ . Letting  $\epsilon = \beta_2 - \beta_1$ , we see that there is an  $\bar{x}$  in  $[a_1, b)$  such that

$$f(\bar{x}) > \beta_2 - (\beta_2 - \beta_1) = \beta_1,$$

so  $\beta_1$  cannot have property (a). Therefore, there cannot be more than one real number that satisfies both (a) and (b). ■

The proof of the following theorem is similar to this (Exercise 2.1.35).

**Theorem 2.1.12** *If  $f$  is bounded on  $[a, x_0)$ , then  $\alpha = \lim_{x \rightarrow x_0^-} f(x)$  exists and is the unique real number with the following properties:*

(a) *If  $\epsilon > 0$ , there is an  $a_1$  in  $[a, x_0)$  such that*

$$f(x) > \alpha - \epsilon \quad \text{if} \quad a_1 \leq x < x_0.$$

(b) *If  $\epsilon > 0$  and  $a_1$  is in  $[a, x_0)$ , then*

$$f(\bar{x}) < \alpha + \epsilon \quad \text{for some } \bar{x} \in [a_1, x_0).$$

## 2.1 Exercises

1. Each of the following conditions fails to define a function on any domain. State why.

(a)  $\sin f(x) = x$

(b)  $e^{f(x)} = -|x|$

(c)  $1 + x^2 + [f(x)]^2 = 0$

(d)  $f(x)[f(x) - 1] = x^2$

2. If

$$f(x) = \sqrt{\frac{(x-3)(x+2)}{x-1}} \quad \text{and} \quad g(x) = \frac{x^2-16}{x-7} \sqrt{x^2-9},$$

find  $D_f$ ,  $D_{f \pm g}$ ,  $D_{fg}$ , and  $D_{f/g}$ .



3. Find  $D_f$ .

(a)  $f(x) = \tan x$

(b)  $f(x) = \frac{1}{\sqrt{1 - |\sin x|}}$

(c)  $f(x) = \frac{1}{x(x-1)}$

(d)  $f(x) = \frac{\sin x}{x}$

(e)  $e^{[f(x)]^2} = x, \quad f(x) \geq 0$

4. Find  $\lim_{x \rightarrow x_0} f(x)$ , and justify your answers with an  $\epsilon$ - $\delta$  proof.

(a)  $x^2 + 2x + 1, \quad x_0 = 1$

(b)  $\frac{x^3 - 8}{x - 2}, \quad x_0 = 2$

(c)  $\frac{1}{x^2 - 1}, \quad x_0 = 0$

(d)  $\sqrt{x}, \quad x_0 = 4$

(e)  $\frac{x^3 - 1}{(x - 1)(x - 2)} + x, \quad x_0 = 1$

5. Prove that Definition 2.1.2 is unchanged if Eqn. (2.1.4) is replaced by

$$|f(x) - L| < K\epsilon,$$

where  $K$  is any positive constant. (That is,  $\lim_{x \rightarrow x_0} f(x) = L$  according to Definition 2.1.2 if and only if  $\lim_{x \rightarrow x_0} f(x) = L$  according to the modified definition.)

6. Use Theorem 2.1.4 and the known limits  $\lim_{x \rightarrow x_0} x = x_0$ ,  $\lim_{x \rightarrow x_0} c = c$  to find the indicated limits.

(a)  $\lim_{x \rightarrow 2} \frac{x^2 + 2x + 3}{2x^3 + 1}$

(b)  $\lim_{x \rightarrow 2} \left( \frac{1}{x+1} - \frac{1}{x-1} \right)$

(c)  $\lim_{x \rightarrow 1} \frac{x-1}{x^3 + x^2 - 2x}$

(d)  $\lim_{x \rightarrow 1} \frac{x^8 - 1}{x^4 - 1}$

7. Find  $\lim_{x \rightarrow x_0^-} f(x)$  and  $\lim_{x \rightarrow x_0^+} f(x)$ , if they exist. Use  $\epsilon$ - $\delta$  proofs, where applicable, to justify your answers.

(a)  $\frac{x + |x|}{x}, \quad x_0 = 0$       (b)  $x \cos \frac{1}{x} + \sin \frac{1}{x} + \sin \frac{1}{|x|}, \quad x_0 = 0$

(c)  $\frac{|x-1|}{x^2 + x - 2}, \quad x_0 = 1$       (d)  $\frac{x^2 + x - 2}{\sqrt{x+2}}, \quad x_0 = -2$

8. Prove: If  $h(x) \geq 0$  for  $a < x < x_0$  and  $\lim_{x \rightarrow x_0^-} h(x)$  exists, then  $\lim_{x \rightarrow x_0^-} h(x) \geq 0$ . Conclude from this that if  $f_2(x) \geq f_1(x)$  for  $a < x < x_0$ , then

$$\lim_{x \rightarrow x_0^-} f_2(x) \geq \lim_{x \rightarrow x_0^-} f_1(x)$$

if both limits exist.

9. (a) Prove: If  $\lim_{x \rightarrow x_0} f(x)$  exists, there is a constant  $M$  and a  $\rho > 0$  such that  $|f(x)| \leq M$  if  $0 < |x - x_0| < \rho$ . (We say then that  $f$  is *bounded* on  $\{x \mid 0 < |x - x_0| < \rho\}$ .)  
 (b) State similar results with “ $\lim_{x \rightarrow x_0}$ ” replaced by “ $\lim_{x \rightarrow x_0^-}$ .”  
 (c) State similar results with “ $\lim_{x \rightarrow x_0}$ ” replaced by “ $\lim_{x \rightarrow x_0^+}$ .”
10. Suppose that  $\lim_{x \rightarrow x_0} f(x) = L$  and  $n$  is a positive integer. Prove that  $\lim_{x \rightarrow x_0} [f(x)]^n = L^n$  (a) by using Theorem 2.1.4 and induction; (b) directly from Definition 2.1.2.  
 HINT: You will find Exercise 2.1.9 useful for (b).
11. Prove: If  $\lim_{x \rightarrow x_0} f(x) = L > 0$ , then  $\lim_{x \rightarrow x_0} \sqrt{f(x)} = \sqrt{L}$ .
12. Prove Theorem 2.1.6.
13. (a) Using the hint stated after Theorem 2.1.6, prove that Theorem 2.1.3 remains valid with “ $\lim_{x \rightarrow x_0}$ ” replaced by “ $\lim_{x \rightarrow x_0^-}$ .”  
 (b) Repeat (a) for Theorem 2.1.4.
14. Define the statement “ $\lim_{x \rightarrow -\infty} f(x) = L$ .”
15. Find  $\lim_{x \rightarrow \infty} f(x)$  if it exists, and justify your answer directly from Definition 2.1.7.  
 (a)  $\frac{1}{x^2 + 1}$                       (b)  $\frac{\sin x}{|x|^\alpha}$  ( $\alpha > 0$ )                      (c)  $\frac{\sin x}{|x|^\alpha}$  ( $\alpha \leq 0$ )  
 (d)  $e^{-x} \sin x$                       (e)  $\tan x$                       (f)  $e^{-x^2} e^{2x}$
16. Theorems 2.1.3 and 2.1.4 remain valid with “ $\lim_{x \rightarrow x_0}$ ” replaced throughout by “ $\lim_{x \rightarrow \infty}$ ” (“ $\lim_{x \rightarrow -\infty}$ ”). How would their proofs have to be changed?
17. Using the definition you gave in Exercise 2.1.14, show that  
 (a)  $\lim_{x \rightarrow -\infty} \left(1 - \frac{1}{x^2}\right) = 1$                       (b)  $\lim_{x \rightarrow -\infty} \frac{2|x|}{1+x} = -2$   
 (c)  $\lim_{x \rightarrow -\infty} \sin x$  does not exist
18. Find  $\lim_{x \rightarrow -\infty} f(x)$ , if it exists, for each function in Exercise 2.1.15. Justify your answers directly from the definition you gave in Exercise 2.1.14.
19. Define  
 (a)  $\lim_{x \rightarrow x_0^-} f(x) = -\infty$     (b)  $\lim_{x \rightarrow x_0^+} f(x) = \infty$     (c)  $\lim_{x \rightarrow x_0^+} f(x) = -\infty$
20. Find  
 (a)  $\lim_{x \rightarrow 0^+} \frac{1}{x^3}$                       (b)  $\lim_{x \rightarrow 0^-} \frac{1}{x^3}$   
 (c)  $\lim_{x \rightarrow 0^+} \frac{1}{x^6}$                       (d)  $\lim_{x \rightarrow 0^-} \frac{1}{x^6}$   
 (e)  $\lim_{x \rightarrow x_0^+} \frac{1}{(x - x_0)^{2k}}$                       (f)  $\lim_{x \rightarrow x_0^-} \frac{1}{(x - x_0)^{2k+1}}$   
 ( $k =$  positive integer)

21. Define

$$(a) \lim_{x \rightarrow x_0} f(x) = \infty$$

$$(b) \lim_{x \rightarrow x_0} f(x) = -\infty$$

22. Find

$$(a) \lim_{x \rightarrow 0} \frac{1}{x^3}$$

$$(b) \lim_{x \rightarrow 0} \frac{1}{x^6}$$

$$(c) \lim_{x \rightarrow x_0} \frac{1}{(x - x_0)^{2k}} \\ (k = \text{positive integer})$$

$$(d) \lim_{x \rightarrow x_0} \frac{1}{(x - x_0)^{2k+1}}$$

23. Define

$$(a) \lim_{x \rightarrow \infty} f(x) = \infty$$

$$(b) \lim_{x \rightarrow -\infty} f(x) = -\infty$$

24. Find

$$(a) \lim_{x \rightarrow \infty} x^{2k}$$

$$(b) \lim_{x \rightarrow -\infty} x^{2k}$$

$$(c) \lim_{x \rightarrow \infty} x^{2k+1} \\ (k = \text{positive integer})$$

$$(d) \lim_{x \rightarrow -\infty} x^{2k+1}$$

$$(e) \lim_{x \rightarrow \infty} \sqrt{x} \sin x$$

$$(f) \lim_{x \rightarrow \infty} e^x$$

25. Suppose that  $f$  and  $g$  are defined on  $(a, \infty)$  and  $(c, \infty)$  respectively, and that  $g(x) > a$  if  $x > c$ . Suppose also that  $\lim_{x \rightarrow \infty} f(x) = L$ , where  $-\infty \leq L \leq \infty$ , and  $\lim_{x \rightarrow \infty} g(x) = \infty$ . Show that  $\lim_{x \rightarrow \infty} f(g(x)) = L$ .

26. (a) Prove:  $\lim_{x \rightarrow x_0} f(x)$  does not exist (finite) if for some  $\epsilon_0 > 0$ , every deleted neighborhood of  $x_0$  contains points  $x_1$  and  $x_2$  such that

$$|f(x_1) - f(x_2)| \geq \epsilon_0.$$

(b) Give analogous conditions for the nonexistence of

$$\lim_{x \rightarrow x_0^+} f(x), \quad \lim_{x \rightarrow x_0^-} f(x), \quad \lim_{x \rightarrow \infty} f(x), \quad \text{and} \quad \lim_{x \rightarrow -\infty} f(x).$$

27. Prove: If  $-\infty < x_0 < \infty$ , then  $\lim_{x \rightarrow x_0} f(x)$  exists in the extended reals if and only if  $\lim_{x \rightarrow x_0^-} f(x)$  and  $\lim_{x \rightarrow x_0^+} f(x)$  both exist in the extended reals and are equal, in which case all three are equal.

*In Exercises 2.1.28–2.1.30 consider only the case where at least one of  $L_1$  and  $L_2$  is  $\pm\infty$ .*

28. Prove: If  $\lim_{x \rightarrow x_0} f(x) = L_1$ ,  $\lim_{x \rightarrow x_0} g(x) = L_2$ , and  $L_1 + L_2$  is not indeterminate, then

$$\lim_{x \rightarrow x_0} (f + g)(x) = L_1 + L_2.$$

29. Prove: If  $\lim_{x \rightarrow \infty} f(x) = L_1$ ,  $\lim_{x \rightarrow \infty} g(x) = L_2$ , and  $L_1 L_2$  is not indeterminate, then

$$\lim_{x \rightarrow \infty} (fg)(x) = L_1 L_2.$$

30. (a) Prove: If  $\lim_{x \rightarrow x_0} f(x) = L_1$ ,  $\lim_{x \rightarrow x_0} g(x) = L_2 \neq 0$ , and  $L_1/L_2$  is not indeterminate, then

$$\lim_{x \rightarrow x_0} \left( \frac{f}{g} \right) (x) = \frac{L_1}{L_2}.$$

- (b) Show that it is necessary to assume that  $L_2 \neq 0$  in (a) by considering  $f(x) = \sin x$ ,  $g(x) = \cos x$ , and  $x_0 = \pi/2$ .

31. Find

(a)  $\lim_{x \rightarrow 0^+} \frac{x^3 + 2x + 3}{2x^4 + 3x^2 + 2}$

(b)  $\lim_{x \rightarrow 0^-} \frac{x^3 + 2x + 3}{2x^4 + 3x^2 + 2}$

(c)  $\lim_{x \rightarrow \infty} \frac{2x^4 + 3x^2 + 2}{x^3 + 2x + 3}$

(d)  $\lim_{x \rightarrow -\infty} \frac{2x^4 + 3x^2 + 2}{x^3 + 2x + 3}$

(e)  $\lim_{x \rightarrow \infty} (e^{x^2} - e^x)$

(f)  $\lim_{x \rightarrow \infty} \frac{x + \sqrt{x} \sin x}{2x + e^{-x}}$

32. Find  $\lim_{x \rightarrow \infty} r(x)$  and  $\lim_{x \rightarrow -\infty} r(x)$  for the rational function

$$r(x) = \frac{a_0 + a_1x + \cdots + a_nx^n}{b_0 + b_1x + \cdots + b_mx^m},$$

where  $a_n \neq 0$  and  $b_m \neq 0$ .

33. Suppose that  $\lim_{x \rightarrow x_0} f(x)$  exists for every  $x_0$  in  $(a, b)$  and  $g(x) = f(x)$  except on a set  $S$  with no limit points in  $(a, b)$ . What can be said about  $\lim_{x \rightarrow x_0} g(x)$  for  $x_0$  in  $(a, b)$ ? Justify your answer.
34. Prove Theorem 2.1.9(b), and complete the proof of Theorem 2.1.9(b) in the case where  $f$  is nonincreasing.

35. Prove Theorem 2.1.12.

36. Show that if  $f$  is bounded on  $[a, x_0)$ , then

(a)  $\underline{\lim}_{x \rightarrow x_0^-} f(x) \leq \overline{\lim}_{x \rightarrow x_0^-} f(x)$ .

(b)  $\underline{\lim}_{x \rightarrow x_0^-} (-f)(x) = -\overline{\lim}_{x \rightarrow x_0^-} f(x)$  and  $\overline{\lim}_{x \rightarrow x_0^-} (-f)(x) = -\underline{\lim}_{x \rightarrow x_0^-} f(x)$ .

(c)  $\underline{\lim}_{x \rightarrow x_0^-} f(x) = \overline{\lim}_{x \rightarrow x_0^-} f(x)$  if and only if  $\lim_{x \rightarrow x_0^-} f(x)$  exists, in which case

$$\lim_{x \rightarrow x_0^-} f(x) = \underline{\lim}_{x \rightarrow x_0^-} f(x) = \overline{\lim}_{x \rightarrow x_0^-} f(x).$$

37. Suppose that  $f$  and  $g$  are bounded on  $[a, x_0)$ .

(a) Show that

$$\overline{\lim}_{x \rightarrow x_0^-} (f + g)(x) \leq \overline{\lim}_{x \rightarrow x_0^-} f(x) + \overline{\lim}_{x \rightarrow x_0^-} g(x).$$

(b) Show that

$$\underline{\lim}_{x \rightarrow x_0^-} (f + g)(x) \geq \underline{\lim}_{x \rightarrow x_0^-} f(x) + \underline{\lim}_{x \rightarrow x_0^-} g(x).$$

(c) State inequalities analogous to those in (a) and (b) for

$$\underline{\lim}_{x \rightarrow x_0^-} (f - g)(x) \quad \text{and} \quad \overline{\lim}_{x \rightarrow x_0^-} (f - g)(x).$$

38. Prove:  $\lim_{x \rightarrow x_0^-} f(x)$  exists (finite) if and only if for each  $\epsilon > 0$  there is a  $\delta > 0$  such that  $|f(x_1) - f(x_2)| < \epsilon$  if  $x_0 - \delta < x_1, x_2 < x_0$ . HINT: For sufficiency, show that  $f$  is bounded on some interval  $(a, x_0)$  and

$$\overline{\lim}_{x \rightarrow x_0^-} f(x) = \underline{\lim}_{x \rightarrow x_0^-} f(x).$$

Then use Exercise 2.1.36(c).

39. Suppose that  $f$  is bounded on an interval  $(x_0, b]$ . Using Definition 2.1.10 as a guide, define  $\overline{\lim}_{x \rightarrow x_0^+} f(x)$  (the right limit superior of  $f$  at  $x_0$ ) and  $\underline{\lim}_{x \rightarrow x_0^+} f(x)$  (the right limit inferior of  $f$  at  $x_0$ ). Then prove that they exist. HINT: Use Theorem 2.1.9.
40. Suppose that  $f$  is bounded on an interval  $(x_0, b]$ . Show that  $\underline{\lim}_{x \rightarrow x_0^+} f(x) = \overline{\lim}_{x \rightarrow x_0^+} f(x)$  if and only if  $\lim_{x \rightarrow x_0^+} f(x)$  exists, in which case

$$\lim_{x \rightarrow x_0^+} f(x) = \underline{\lim}_{x \rightarrow x_0^+} f(x) = \overline{\lim}_{x \rightarrow x_0^+} f(x).$$

41. Suppose that  $f$  is bounded on an open interval containing  $x_0$ . Show that  $\lim_{x \rightarrow x_0} f(x)$  exists if and only if

$$\overline{\lim}_{x \rightarrow x_0^-} f(x) = \overline{\lim}_{x \rightarrow x_0^+} f(x) = \underline{\lim}_{x \rightarrow x_0^-} f(x) = \underline{\lim}_{x \rightarrow x_0^+} f(x),$$

in which case  $\lim_{x \rightarrow x_0} f(x)$  is the common value of these four expressions.

## 2.2 CONTINUITY

In this section we study continuous functions of a real variable. We will prove some important theorems about continuous functions that, although intuitively plausible, are beyond the scope of the elementary calculus course. They are accessible now because of our better understanding of the real number system, especially of those properties that stem from the completeness axiom.

The definitions of

$$f(x_0-) = \lim_{x \rightarrow x_0-} f(x), \quad f(x_0+) = \lim_{x \rightarrow x_0+} f(x), \quad \text{and} \quad \lim_{x \rightarrow x_0} f(x)$$

do not involve  $f(x_0)$  or even require that it be defined. However, the case where  $f(x_0)$  is defined and equal to one or more of these quantities is important.

### Definition 2.2.1

- (a) We say that  $f$  is *continuous at*  $x_0$  if  $f$  is defined on an open interval  $(a, b)$  containing  $x_0$  and  $\lim_{x \rightarrow x_0} f(x) = f(x_0)$ .
- (b) We say that  $f$  is *continuous from the left at*  $x_0$  if  $f$  is defined on an open interval  $(a, x_0)$  and  $f(x_0-) = f(x_0)$ .
- (c) We say that  $f$  is *continuous from the right at*  $x_0$  if  $f$  is defined on an open interval  $(x_0, b)$  and  $f(x_0+) = f(x_0)$ . ■

The following theorem provides a method for determining whether these definitions are satisfied. The proof, which we leave to you (Exercise 2.2.1), rests on Definitions 2.1.2, 2.1.5, and 2.2.1.

### Theorem 2.2.2

- (a) A function  $f$  is continuous at  $x_0$  if and only if  $f$  is defined on an open interval  $(a, b)$  containing  $x_0$  and for each  $\epsilon > 0$  there is a  $\delta > 0$  such that

$$|f(x) - f(x_0)| < \epsilon \tag{2.2.1}$$

whenever  $|x - x_0| < \delta$ .

- (b) A function  $f$  is continuous from the right at  $x_0$  if and only if  $f$  is defined on an interval  $[x_0, b)$  and for each  $\epsilon > 0$  there is a  $\delta > 0$  such that (2.2.1) holds whenever  $x_0 \leq x < x_0 + \delta$ .
- (c) A function  $f$  is continuous from the left at  $x_0$  if and only if  $f$  is defined on an interval  $(a, x_0]$  and for each  $\epsilon > 0$  there is a  $\delta > 0$  such that (2.2.1) holds whenever  $x_0 - \delta < x \leq x_0$ .

From Definition 2.2.1 and Theorem 2.2.2,  $f$  is continuous at  $x_0$  if and only if

$$f(x_0-) = f(x_0+) = f(x_0)$$

or, equivalently, if and only if it is continuous from the right and left at  $x_0$  (Exercise 2.2.2).

**Example 2.2.1** Let  $f$  be defined on  $[0, 2]$  by

$$f(x) = \begin{cases} x^2, & 0 \leq x < 1, \\ x + 1, & 1 \leq x \leq 2 \end{cases}$$

(Figure 2.2.1); then

$$\begin{aligned} f(0+) &= 0 = f(0), \\ f(1-) &= 1 \neq f(1) = 2, \\ f(1+) &= 2 = f(1), \\ f(2-) &= 3 = f(2). \end{aligned}$$

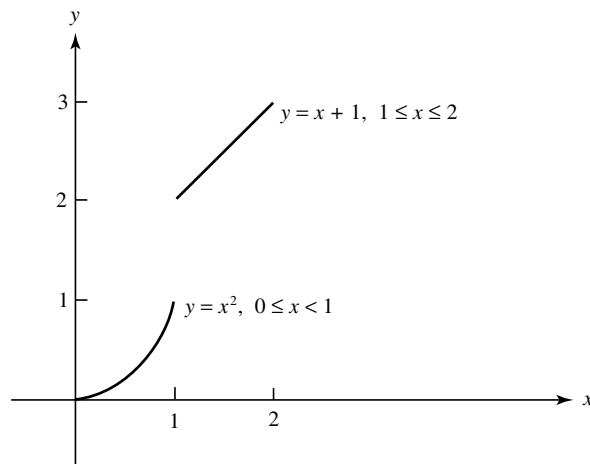
Therefore,  $f$  is continuous from the right at 0 and 1 and continuous from the left at 2, but not at 1. If  $0 < x, x_0 < 1$ , then

$$\begin{aligned} |f(x) - f(x_0)| &= |x^2 - x_0^2| = |x - x_0| |x + x_0| \\ &\leq 2|x - x_0| < \epsilon \quad \text{if} \quad |x - x_0| < \epsilon/2. \end{aligned}$$

Hence,  $f$  is continuous at each  $x_0$  in  $(0, 1)$ . If  $1 < x, x_0 < 2$ , then

$$\begin{aligned} |f(x) - f(x_0)| &= |(x + 1) - (x_0 + 1)| = |x - x_0| \\ &< \epsilon \quad \text{if} \quad |x - x_0| < \epsilon. \end{aligned}$$

Hence,  $f$  is continuous at each  $x_0$  in  $(1, 2)$ .



**Figure 2.2.1**

**Definition 2.2.3** A function  $f$  is *continuous on an open interval*  $(a, b)$  if it is continuous at every point in  $(a, b)$ . If, in addition,

$$f(b-) = f(b) \tag{2.2.2}$$

or

$$f(a+) = f(a) \tag{2.2.3}$$

then  $f$  is *continuous on*  $(a, b)$  or  $[a, b)$ , respectively. If  $f$  is continuous on  $(a, b)$  and (2.2.2) and (2.2.3) both hold, then  $f$  is *continuous on*  $[a, b)$ . More generally, if  $S$  is a subset of  $D_f$  consisting of finitely or infinitely many disjoint intervals, then  $f$  is *continuous on*  $S$  if  $f$  is continuous on every interval in  $S$ . (Henceforth, in connection with functions of one variable, whenever we say “ $f$  is continuous on  $S$ ” we mean that  $S$  is a set of this kind.)

**Example 2.2.2** Let  $f(x) = \sqrt{x}$ ,  $0 \leq x < \infty$ . Then

$$|f(x) - f(0)| = \sqrt{x} < \epsilon \quad \text{if} \quad 0 \leq x < \epsilon^2,$$

so  $f(0+) = f(0)$ . If  $x_0 > 0$  and  $x \geq 0$ , then

$$\begin{aligned} |f(x) - f(x_0)| &= |\sqrt{x} - \sqrt{x_0}| = \frac{|x - x_0|}{\sqrt{x} + \sqrt{x_0}} \\ &\leq \frac{|x - x_0|}{\sqrt{x_0}} < \epsilon \quad \text{if} \quad |x - x_0| < \epsilon\sqrt{x_0}, \end{aligned}$$

so  $\lim_{x \rightarrow x_0} f(x) = f(x_0)$ . Hence,  $f$  is continuous on  $[0, \infty)$ .

**Example 2.2.3** The function

$$g(x) = \frac{1}{\sin \pi x}$$

is continuous on  $S = \bigcup_{n=-\infty}^{\infty} (n, n+1)$ . However,  $g$  is not continuous at any  $x_0 = n$  (integer), since it is not defined at such points. ■

The function  $f$  defined in Example 2.2.1 (see also Figure 2.2.1) is continuous on  $[0, 1)$  and  $[1, 2]$ , but not on any open interval containing 1. The discontinuity of  $f$  there is of the simplest kind, described in the following definition.

**Definition 2.2.4** A function  $f$  is *piecewise continuous* on  $[a, b]$  if

- (a)  $f(x_0+)$  exists for all  $x_0$  in  $[a, b)$ ;
- (b)  $f(x_0-)$  exists for all  $x_0$  in  $(a, b]$ ;
- (c)  $f(x_0+) = f(x_0-) = f(x_0)$  for all but finitely many points  $x_0$  in  $(a, b)$ .

If (c) fails to hold at some  $x_0$  in  $(a, b)$ ,  $f$  has a *jump discontinuity* at  $x_0$ . Also,  $f$  has a *jump discontinuity* at  $a$  if  $f(a+) \neq f(a)$  or at  $b$  if  $f(b-) \neq f(b)$ .

**Example 2.2.4** The function

$$f(x) = \begin{cases} 1, & x = 0, \\ x, & 0 < x < 1, \\ 2, & x = 1, \\ x, & 1 < x \leq 2, \\ -1, & 2 < x < 3, \\ 0, & x = 3, \end{cases}$$

(Figure 2.2.2) is the graph of a piecewise continuous function on  $[0, 3]$ , with jump discontinuities at  $x_0 = 0, 1, 2$ , and 3.



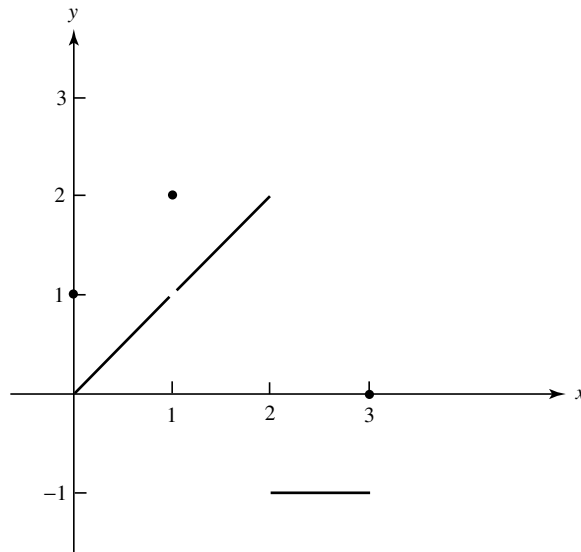


Figure 2.2.2

The reason for the adjective “jump” can be seen in Figures 2.2.1 and 2.2.2, where the graphs exhibit a definite jump at each point of discontinuity. The next example shows that not all discontinuities are of this kind.

**Example 2.2.5** The function

$$f(x) = \begin{cases} \sin \frac{1}{x}, & x \neq 0, \\ 0, & x = 0, \end{cases}$$

is continuous at all  $x_0$  except  $x_0 = 0$ . As  $x$  approaches 0 from either side,  $f(x)$  oscillates between  $-1$  and  $1$  with ever-increasing frequency, so neither  $f(0+)$  nor  $f(0-)$  exists. Therefore, the discontinuity of  $f$  at 0 is not a jump discontinuity, and if  $\rho > 0$ , then  $f$  is not piecewise continuous on any interval of the form  $[-\rho, 0]$ ,  $[-\rho, \rho]$ , or  $[0, \rho]$ . ■

Theorems 2.1.4 and 2.2.2 imply the next theorem (Exercise 2.2.18).

**Theorem 2.2.5** *If  $f$  and  $g$  are continuous on a set  $S$ , then so are  $f + g$ ,  $f - g$ , and  $fg$ . In addition,  $f/g$  is continuous at each  $x_0$  in  $S$  such that  $g(x_0) \neq 0$ .*

**Example 2.2.6** Since the constant functions and the function  $f(x) = x$  are continuous for all  $x$ , successive applications of the various parts of Theorem 2.2.5 imply that the function

$$r(x) = \frac{9 - x^2}{x + 1}$$

is continuous for all  $x$  except  $x = -1$  (see Example 2.1.7). More generally, by starting from Theorem 2.2.5 and using

induction, it can be shown that if  $f_1, f_2, \dots, f_n$  are continuous on a set  $S$ , then so are  $f_1 + f_2 + \dots + f_n$  and  $f_1 f_2 \dots f_n$ . Therefore, any rational function

$$r(x) = \frac{a_0 + a_1x + \dots + a_nx^n}{b_0 + b_1x + \dots + b_mx^m} \quad (b_m \neq 0)$$

is continuous for all values of  $x$  except those for which its denominator vanishes.

### Removable Discontinuities

Let  $f$  be defined on a deleted neighborhood of  $x_0$  and discontinuous (perhaps even undefined) at  $x_0$ . We say that  $f$  has a removable discontinuity at  $x_0$  if  $\lim_{x \rightarrow x_0} f(x)$  exists. In this case, the function

$$g(x) = \begin{cases} f(x) & \text{if } x \in D_f \text{ and } x \neq x_0, \\ \lim_{x \rightarrow x_0} f(x) & \text{if } x = x_0, \end{cases}$$

is continuous at  $x_0$ .

**Example 2.2.7** The function

$$f(x) = x \sin \frac{1}{x}$$

is not defined at  $x_0 = 0$ , and therefore certainly not continuous there, but  $\lim_{x \rightarrow 0} f(x) = 0$  (Example 2.1.6). Therefore,  $f$  has a removable discontinuity at 0.

The function

$$f_1(x) = \sin \frac{1}{x}$$

is undefined at 0 and its discontinuity there is not removable, since  $\lim_{x \rightarrow 0} f_1(x)$  does not exist (Example 2.2.5).

### Composite Functions

We have seen that the investigation of limits and continuity can be simplified by regarding a given function as the result of addition, subtraction, multiplication, and division of simpler functions. Another operation useful in this connection is *composition* of functions; that is, substitution of one function into another.

**Definition 2.2.6** Suppose that  $f$  and  $g$  are functions with domains  $D_f$  and  $D_g$ . If  $D_g$  has a nonempty subset  $T$  such that  $g(x) \in D_f$  whenever  $x \in T$ , then the *composite function*  $f \circ g$  is defined on  $T$  by

$$(f \circ g)(x) = f(g(x)).$$

**Example 2.2.8** If

$$f(x) = \log x \quad \text{and} \quad g(x) = \frac{1}{1-x^2},$$

then

$$D_f = (0, \infty) \quad \text{and} \quad D_g = \{x \mid x \neq \pm 1\}.$$

Since  $g(x) > 0$  if  $x \in T = (-1, 1)$ , the composite function  $f \circ g$  is defined on  $(-1, 1)$  by

$$(f \circ g)(x) = \log \frac{1}{1-x^2}.$$

We leave it to you to verify that  $g \circ f$  is defined on  $(0, 1/e) \cup (1/e, e) \cup (e, \infty)$  by

$$(g \circ f)(x) = \frac{1}{1 - (\log x)^2}. \quad \blacksquare$$

The next theorem says that the composition of continuous functions is continuous.

**Theorem 2.2.7** *Suppose that  $g$  is continuous at  $x_0$ ,  $g(x_0)$  is an interior point of  $D_f$ , and  $f$  is continuous at  $g(x_0)$ . Then  $f \circ g$  is continuous at  $x_0$ .*

**Proof** Suppose that  $\epsilon > 0$ . Since  $g(x_0)$  is an interior point of  $D_f$  and  $f$  is continuous at  $g(x_0)$ , there is a  $\delta_1 > 0$  such that  $f(t)$  is defined and

$$|f(t) - f(g(x_0))| < \epsilon \quad \text{if} \quad |t - g(x_0)| < \delta_1. \quad (2.2.4)$$

Since  $g$  is continuous at  $x_0$ , there is a  $\delta > 0$  such that  $g(x)$  is defined and

$$|g(x) - g(x_0)| < \delta_1 \quad \text{if} \quad |x - x_0| < \delta. \quad (2.2.5)$$

Now (2.2.4) and (2.2.5) imply that

$$|f(g(x)) - f(g(x_0))| < \epsilon \quad \text{if} \quad |x - x_0| < \delta.$$

Therefore,  $f \circ g$  is continuous at  $x_0$ . ■

See Exercise 2.2.22 for a related result concerning limits.

**Example 2.2.9** In Examples 2.2.2 and 2.2.6 we saw that the function

$$f(x) = \sqrt{x}$$

is continuous for  $x > 0$ , and the function

$$g(x) = \frac{9-x^2}{x+1}$$

is continuous for  $x \neq -1$ . Since  $g(x) > 0$  if  $x < -3$  or  $-1 < x < 3$ , Theorem 2.2.7 implies that the function

$$(f \circ g)(x) = \sqrt{\frac{9-x^2}{x+1}}$$

is continuous on  $(-\infty, -3) \cup (-1, 3)$ . It is also continuous from the left at  $-3$  and  $3$ .

**Bounded Functions**

A function  $f$  is *bounded below* on a set  $S$  if there is a real number  $m$  such that

$$f(x) \geq m \text{ for all } x \in S.$$

In this case, the set

$$V = \{f(x) \mid x \in S\}$$

has an infimum  $\alpha$ , and we write

$$\alpha = \inf_{x \in S} f(x).$$

If there is a point  $x_1$  in  $S$  such that  $f(x_1) = \alpha$ , we say that  $\alpha$  is the *minimum of  $f$  on  $S$* , and write

$$\alpha = \min_{x \in S} f(x).$$

Similarly,  $f$  is *bounded above on  $S$*  if there is a real number  $M$  such that  $f(x) \leq M$  for all  $x$  in  $S$ . In this case,  $V$  has a supremum  $\beta$ , and we write

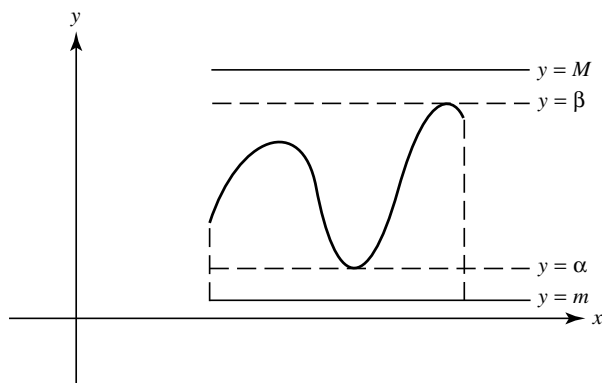
$$\beta = \sup_{x \in S} f(x).$$

If there is a point  $x_2$  in  $S$  such that  $f(x_2) = \beta$ , we say that  $\beta$  is the *maximum of  $f$  on  $S$* , and write

$$\beta = \max_{x \in S} f(x).$$

If  $f$  is bounded above and below on a set  $S$ , we say that  $f$  is *bounded on  $S$* .

Figure 2.2.3 illustrates the geometric meaning of these definitions for a function  $f$  bounded on an interval  $S = [a, b]$ . The graph of  $f$  lies in the strip bounded by the lines  $y = M$  and  $y = m$ , where  $M$  is any upper bound and  $m$  is any lower bound for  $f$  on  $[a, b]$ . The narrowest strip containing the graph is the one bounded above by  $y = \beta = \sup_{a \leq x \leq b} f(x)$  and below by  $y = \alpha = \inf_{a \leq x \leq b} f(x)$ .



**Figure 2.2.3**

**Example 2.2.10** The function

$$g(x) = \begin{cases} \frac{1}{2}, & x = 0 \text{ or } x = 1, \\ 1 - x, & 0 < x < 1, \end{cases} +$$

(Figure 2.2.4(a)) is bounded on  $[0, 1]$ , and

$$\sup_{0 \leq x \leq 1} g(x) = 1, \quad \inf_{0 \leq x \leq 1} g(x) = 0.$$

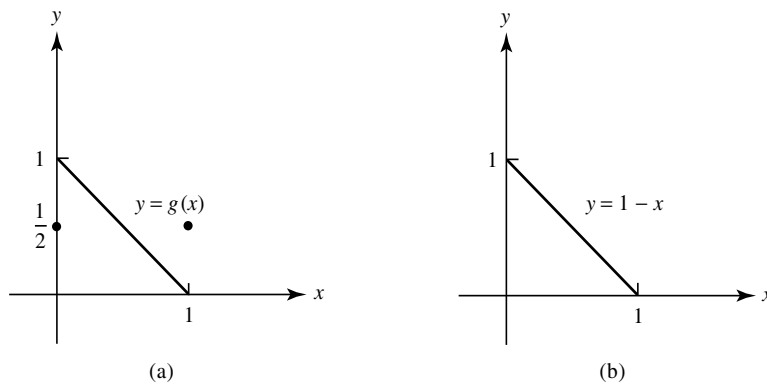
Therefore,  $g$  has no maximum or minimum on  $[0, 1]$ , since it does not assume either of the values 0 and 1.

The function

$$h(x) = 1 - x, \quad 0 \leq x \leq 1,$$

which differs from  $g$  only at 0 and 1 (Figure 2.2.4(b)), has the same supremum and infimum as  $g$ , but it attains these values at  $x = 0$  and  $x = 1$ , respectively; therefore,

$$\max_{0 \leq x \leq 1} h(x) = 1 \quad \text{and} \quad \min_{0 \leq x \leq 1} h(x) = 0.$$



**Figure 2.2.4**

**Example 2.2.11** The function

$$f(x) = e^{x(x-1)} \sin \frac{1}{x(x-1)}, \quad 0 < x < 1,$$

oscillates between  $\pm e^{x(x-1)}$  infinitely often in every interval of the form  $(0, \rho)$  or  $(1-\rho, 1)$ , where  $0 < \rho < 1$ , and

$$\sup_{0 < x < 1} f(x) = 1, \quad \inf_{0 < x < 1} f(x) = -1.$$

However,  $f$  does not assume these values, so  $f$  has no maximum or minimum on  $(0, 1)$ .

**Theorem 2.2.8** *If  $f$  is continuous on a finite closed interval  $[a, b]$ , then  $f$  is bounded on  $[a, b]$ .*

**Proof** Suppose that  $t \in [a, b]$ . Since  $f$  is continuous at  $t$ , there is an open interval  $I_t$  containing  $t$  such that

$$|f(x) - f(t)| < 1 \quad \text{if} \quad x \in I_t \cap [a, b]. \quad (2.2.6)$$

(To see this, set  $\epsilon = 1$  in (2.2.1), Theorem 2.2.2.) The collection  $\mathcal{H} = \{I_t \mid a \leq t \leq b\}$  is an open covering of  $[a, b]$ . Since  $[a, b]$  is compact, the Heine–Borel theorem implies that there are finitely many points  $t_1, t_2, \dots, t_n$  such that the intervals  $I_{t_1}, I_{t_2}, \dots, I_{t_n}$  cover  $[a, b]$ . According to (2.2.6) with  $t = t_i$ ,

$$|f(x) - f(t_i)| < 1 \quad \text{if} \quad x \in I_{t_i} \cap [a, b].$$

Therefore,

$$\begin{aligned} |f(x)| &= |(f(x) - f(t_i)) + f(t_i)| \leq |f(x) - f(t_i)| + |f(t_i)| \\ &\leq 1 + |f(t_i)| \quad \text{if} \quad x \in I_{t_i} \cap [a, b]. \end{aligned} \quad (2.2.7)$$

Let

$$M = 1 + \max_{1 \leq i \leq n} |f(t_i)|.$$

Since  $[a, b] \subset \bigcup_{i=1}^n (I_{t_i} \cap [a, b])$ , (2.2.7) implies that  $|f(x)| \leq M$  if  $x \in [a, b]$ . ■

This proof illustrates the utility of the Heine–Borel theorem, which allows us to choose  $M$  as the largest of a *finite* set of numbers.

Theorem 2.2.8 and the completeness of the reals imply that

if  $f$  is continuous on a finite closed interval  $[a, b]$ , then  $f$  has an infimum and a supremum on  $[a, b]$ . The next theorem shows that  $f$  actually assumes these values at some points in  $[a, b]$ .

**Theorem 2.2.9** *Suppose that  $f$  is continuous on a finite closed interval  $[a, b]$ . Let*

$$\alpha = \inf_{a \leq x \leq b} f(x) \quad \text{and} \quad \beta = \sup_{a \leq x \leq b} f(x).$$

*Then  $\alpha$  and  $\beta$  are respectively the minimum and maximum of  $f$  on  $[a, b]$ ; that is, there are points  $x_1$  and  $x_2$  in  $[a, b]$  such that*

$$f(x_1) = \alpha \quad \text{and} \quad f(x_2) = \beta.$$

**Proof** We show that  $x_1$  exists and leave it to you to show that  $x_2$  exists (Exercise 2.2.24).

Suppose that there is no  $x_1$  in  $[a, b]$  such that  $f(x_1) = \alpha$ . Then  $f(x) > \alpha$  for all  $x \in [a, b]$ . We will show that this leads to a contradiction.

Suppose that  $t \in [a, b]$ . Then  $f(t) > \alpha$ , so

$$f(t) > \frac{f(t) + \alpha}{2} > \alpha.$$

Since  $f$  is continuous at  $t$ , there is an open interval  $I_t$  about  $t$  such that

$$f(x) > \frac{f(t) + \alpha}{2} \quad \text{if } x \in I_t \cap [a, b] \quad (2.2.8)$$

(Exercise 2.2.15). The collection  $\mathcal{H} = \{I_t \mid a \leq t \leq b\}$  is an open covering of  $[a, b]$ . Since  $[a, b]$  is compact, the Heine–Borel theorem implies that there are finitely many points  $t_1, t_2, \dots, t_n$  such that the intervals  $I_{t_1}, I_{t_2}, \dots, I_{t_n}$  cover  $[a, b]$ . Define

$$\alpha_1 = \min_{1 \leq i \leq n} \frac{f(t_i) + \alpha}{2}.$$

Then, since  $[a, b] \subset \bigcup_{i=1}^n (I_{t_i} \cap [a, b])$ , (2.2.8) implies that

$$f(t) > \alpha_1, \quad a \leq t \leq b.$$

But  $\alpha_1 > \alpha$ , so this contradicts the definition of  $\alpha$ . Therefore,  $f(x_1) = \alpha$  for some  $x_1$  in  $[a, b]$ . ■

**Example 2.2.12** We used the compactness of  $[a, b]$  in the proof of Theorem 2.2.9 when we invoked the Heine–Borel theorem. To see that compactness is essential to the proof, consider the function

$$g(x) = 1 - (1 - x) \sin \frac{1}{x},$$

which is continuous and has supremum 2 on the noncompact interval  $(0, 1]$ , but does not assume its supremum on  $(0, 1]$ , since

$$\begin{aligned} g(x) &\leq 1 + (1 - x) \left| \sin \frac{1}{x} \right| \\ &\leq 1 + (1 - x) < 2 \quad \text{if } 0 < x \leq 1. \end{aligned}$$

As another example, consider the function

$$f(x) = e^{-x},$$

which is continuous and has infimum 0, which it does not attain, on the noncompact interval  $(0, \infty)$ . ■

The next theorem shows that if  $f$  is continuous on a finite closed interval  $[a, b]$ , then  $f$  assumes every value between  $f(a)$  and  $f(b)$  as  $x$  varies from  $a$  to  $b$  (Figure 2.2.5, page 64).

**Theorem 2.2.10 (Intermediate Value Theorem)** *Suppose that  $f$  is continuous on  $[a, b]$ ,  $f(a) \neq f(b)$ , and  $\mu$  is between  $f(a)$  and  $f(b)$ . Then  $f(c) = \mu$  for some  $c$  in  $(a, b)$ .*

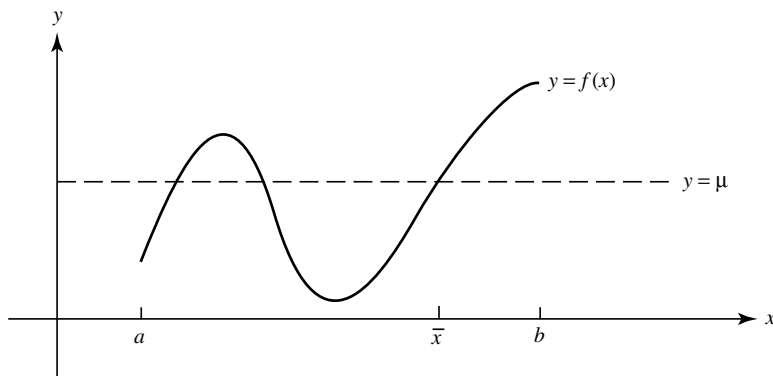


Figure 2.2.5

**Proof** Suppose that  $f(a) < \mu < f(b)$ . The set

$$S = \{x \mid a \leq x \leq b \text{ and } f(x) \leq \mu\}$$

is bounded and nonempty. Let  $c = \sup S$ . We will show that  $f(c) = \mu$ . If  $f(c) > \mu$ , then  $c > a$  and, since  $f$  is continuous at  $c$ , there is an  $\epsilon > 0$  such that  $f(x) > \mu$  if  $c - \epsilon < x \leq c$  (Exercise 2.2.15). Therefore,  $c - \epsilon$  is an upper bound for  $S$ , which contradicts the definition of  $c$  as the supremum of  $S$ . If  $f(c) < \mu$ , then  $c < b$  and there is an  $\epsilon > 0$  such that  $f(x) < \mu$  for  $c \leq x < c + \epsilon$ , so  $c$  is not an upper bound for  $S$ . This is also a contradiction. Therefore,  $f(c) = \mu$ .

The proof for the case where  $f(b) < \mu < f(a)$  can be obtained by applying this result to  $-f$ . ■

## Uniform Continuity

Theorem 2.2.2 and Definition 2.2.3 imply that a

function  $f$  is continuous on a subset  $S$  of its domain if for each  $\epsilon > 0$  and each  $x_0$  in  $S$ , there is a  $\delta > 0$ , which may depend upon  $x_0$  as well as  $\epsilon$ , such that

$$|f(x) - f(x_0)| < \epsilon \quad \text{if} \quad |x - x_0| < \delta \quad \text{and} \quad x \in D_f.$$

The next definition introduces another kind of continuity on a set  $S$ .

**Definition 2.2.11** A function  $f$  is *uniformly continuous* on a subset  $S$  of its domain if, for every  $\epsilon > 0$ , there is a  $\delta > 0$  such that

$$|f(x) - f(x')| < \epsilon \quad \text{whenever} \quad |x - x'| < \delta \quad \text{and} \quad x, x' \in S. \quad \blacksquare$$

We emphasize that in this definition  $\delta$  depends only on  $\epsilon$  and  $S$  and not on the particular choice of  $x$  and  $x'$ , provided that they are both in  $S$ .

**Example 2.2.13** The function

$$f(x) = 2x$$



is uniformly continuous on  $(-\infty, \infty)$ , since

$$|f(x) - f(x')| = 2|x - x'| < \epsilon \quad \text{if} \quad |x - x'| < \epsilon/2.$$

**Example 2.2.14** If  $0 < r < \infty$ , then the function

$$g(x) = x^2$$

is uniformly continuous on  $[-r, r]$ . To see this, note that

$$|g(x) - g(x')| = |x^2 - (x')^2| = |x - x'| |x + x'| \leq 2r|x - x'|,$$

so

$$|g(x) - g(x')| < \epsilon \quad \text{if} \quad |x - x'| < \delta = \frac{\epsilon}{2r} \quad \text{and} \quad -r \leq x, x' \leq r. \quad \blacksquare$$

Often a concept is clarified by considering its negation: a function  $f$  is *not* uniformly continuous on  $S$  if there is an  $\epsilon_0 > 0$  such that if  $\delta$  is any positive number, there are points  $x$  and  $x'$  in  $S$  such that

$$|x - x'| < \delta \quad \text{but} \quad |f(x) - f(x')| \geq \epsilon_0.$$

**Example 2.2.15** The function  $g(x) = x^2$  is uniformly continuous on  $[-r, r]$  for any finite  $r$  (Example 2.2.14), but not on  $(-\infty, \infty)$ . To see this, we will show that if  $\delta > 0$  there are real numbers  $x$  and  $x'$  such that

$$|x - x'| = \delta/2 \quad \text{and} \quad |g(x) - g(x')| \geq 1.$$

To this end, we write

$$|g(x) - g(x')| = |x^2 - (x')^2| = |x - x'| |x + x'|.$$

If  $|x - x'| = \delta/2$  and  $x, x' > 1/\delta$ , then

$$|x - x'| |x + x'| > \frac{\delta}{2} \left( \frac{1}{\delta} + \frac{1}{\delta} \right) = 1.$$

**Example 2.2.16** The function

$$f(x) = \cos \frac{1}{x}$$

is continuous on  $(0, 1]$  (Exercise 2.2.23(i)). However,  $f$  is not uniformly continuous on  $(0, 1]$ , since

$$\left| f\left(\frac{1}{n\pi}\right) - f\left(\frac{1}{(n+1)\pi}\right) \right| = 2, \quad n = 1, 2, \dots \quad \blacksquare$$

Examples 2.2.15 and 2.2.16 show that a function may be continuous but not uniformly continuous on an interval. The next theorem shows that this cannot happen if the interval is closed and bounded, and therefore compact.

**Theorem 2.2.12** *If  $f$  is continuous on a closed and bounded interval  $[a, b]$ , then  $f$  is uniformly continuous on  $[a, b]$ .*

**Proof** Suppose that  $\epsilon > 0$ . Since  $f$  is continuous on  $[a, b]$ , for each  $t$  in  $[a, b]$  there is a positive number  $\delta_t$  such that

$$|f(x) - f(t)| < \frac{\epsilon}{2} \quad \text{if} \quad |x - t| < 2\delta_t \quad \text{and} \quad x \in [a, b]. \quad (2.2.9)$$

If  $I_t = (t - \delta_t, t + \delta_t)$ , the collection

$$\mathcal{H} = \{I_t \mid t \in [a, b]\}$$

is an open covering of  $[a, b]$ . Since  $[a, b]$  is compact, the Heine–Borel theorem implies that there are finitely many points  $t_1, t_2, \dots, t_n$  in  $[a, b]$  such that  $I_{t_1}, I_{t_2}, \dots, I_{t_n}$  cover  $[a, b]$ . Now define

$$\delta = \min\{\delta_{t_1}, \delta_{t_2}, \dots, \delta_{t_n}\}. \quad (2.2.10)$$

We will show that if

$$|x - x'| < \delta \quad \text{and} \quad x, x' \in [a, b], \quad (2.2.11)$$

then  $|f(x) - f(x')| < \epsilon$ .

From the triangle inequality,

$$\begin{aligned} |f(x) - f(x')| &= |(f(x) - f(t_r)) + (f(t_r) - f(x'))| \\ &\leq |f(x) - f(t_r)| + |f(t_r) - f(x')|. \end{aligned} \quad (2.2.12)$$

Since  $I_{t_1}, I_{t_2}, \dots, I_{t_n}$  cover  $[a, b]$ ,  $x$  must be in one of these intervals. Suppose that  $x \in I_{t_r}$ ; that is,

$$|x - t_r| < \delta_{t_r}. \quad (2.2.13)$$

From (2.2.9) with  $t = t_r$ ,

$$|f(x) - f(t_r)| < \frac{\epsilon}{2}. \quad (2.2.14)$$

From (2.2.11), (2.2.13), and the triangle inequality,

$$|x' - t_r| = |(x' - x) + (x - t_r)| \leq |x' - x| + |x - t_r| < \delta + \delta_{t_r} \leq 2\delta_{t_r}.$$

Therefore, (2.2.9) with  $t = t_r$  and  $x$  replaced by  $x'$  implies that

$$|f(x') - f(t_r)| < \frac{\epsilon}{2}.$$

This, (2.2.12), and (2.2.14) imply that  $|f(x) - f(x')| < \epsilon$ . ■

This proof again shows the utility of the Heine–Borel theorem, which allowed us to define  $\delta$  in (2.2.10) as the smallest of a *finite* set of positive numbers, so that  $\delta$  is sure to be positive. (An infinite set of positive numbers may fail to have a smallest positive member; for example, consider the open interval  $(0, 1)$ .)

**Corollary 2.2.13** *If  $f$  is continuous on a set  $T$ , then  $f$  is uniformly continuous on any finite closed interval contained in  $T$ .*

Applied to Example 2.2.16, Corollary 2.2.13 implies that the function  $g(x) = \cos 1/x$  is uniformly continuous on  $[\rho, 1]$  if  $0 < \rho < 1$ .

### More About Monotonic Functions

Theorem 2.1.9 implies that if  $f$  is monotonic on an interval  $I$ , then  $f$  is either continuous or has a jump discontinuity at each  $x_0$  in  $I$ . This and Theorem 2.2.10 provide the key to the proof of the following theorem.

**Theorem 2.2.14** *If  $f$  is monotonic and nonconstant on  $[a, b]$ , then  $f$  is continuous on  $[a, b]$  if and only if its range  $R_f = \{f(x) \mid x \in [a, b]\}$  is the closed interval with endpoints  $f(a)$  and  $f(b)$ .*

**Proof** We assume that  $f$  is nondecreasing, and leave the case where  $f$  is nonincreasing to you (Exercise 2.2.34). Theorem 2.1.9(a) implies that the set  $\widetilde{R}_f = \{f(x) \mid x \in (a, b)\}$  is a subset of the open interval  $(f(a+), f(b-))$ . Therefore,

$$R_f = \{f(a)\} \cup \widetilde{R}_f \cup \{f(b)\} \subset \{f(a)\} \cup (f(a+), f(b-)) \cup \{f(b)\}. \quad (2.2.15)$$

Now suppose that  $f$  is continuous on  $[a, b]$ . Then  $f(a) = f(a+)$ ,  $f(b-) = f(b)$ , so (2.2.15) implies that  $R_f \subset [f(a), f(b)]$ . If  $f(a) < \mu < f(b)$ , then Theorem 2.2.10 implies that  $\mu = f(x)$  for some  $x$  in  $(a, b)$ . Hence,  $R_f = [f(a), f(b)]$ .

For the converse, suppose that  $R_f = [f(a), f(b)]$ . Since  $f(a) \leq f(a+)$  and  $f(b-) \leq f(b)$ , (2.2.15) implies that  $f(a) = f(a+)$  and  $f(b-) = f(b)$ . We know from Theorem 2.1.9(c) that if  $f$  is nondecreasing and  $a < x_0 < b$ , then

$$f(x_0-) \leq f(x_0) \leq f(x_0+).$$

If either of these inequalities is strict,  $R_f$  cannot be an interval. Since this contradicts our assumption,  $f(x_0-) = f(x_0) = f(x_0+)$ . Therefore,  $f$  is continuous at  $x_0$  (Exercise 2.2.2). We can now conclude that  $f$  is continuous on  $[a, b]$ . ■

Theorem 2.2.14 implies the following theorem.

**Theorem 2.2.15** *Suppose that  $f$  is increasing and continuous on  $[a, b]$ , and let  $f(a) = c$  and  $f(b) = d$ . Then there is a unique function  $g$  defined on  $[c, d]$  such that*

$$g(f(x)) = x, \quad a \leq x \leq b, \quad (2.2.16)$$

and

$$f(g(y)) = y, \quad c \leq y \leq d. \quad (2.2.17)$$

Moreover,  $g$  is continuous and increasing on  $[c, d]$ .

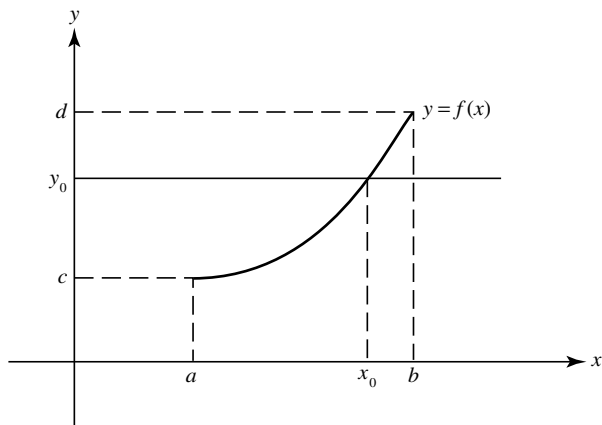
**Proof** We first show that there is a function  $g$  satisfying (2.2.16) and (2.2.17). Since  $f$  is continuous, Theorem 2.2.14 implies that for each  $y_0$  in  $[c, d]$  there is an  $x_0$  in  $[a, b]$  such that

$$f(x_0) = y_0, \quad (2.2.18)$$

and, since  $f$  is increasing, there is only one such  $x_0$ . Define

$$g(y_0) = x_0. \quad (2.2.19)$$

The definition of  $x_0$  is illustrated in Figure 2.2.6: with  $[c, d]$  drawn on the  $y$ -axis, find the intersection of the line  $y = y_0$  with the curve  $y = f(x)$  and drop a vertical from the intersection to the  $x$ -axis to find  $x_0$ .



**Figure 2.2.6**

Substituting (2.2.19) into (2.2.18) yields

$$f(g(y_0)) = y_0,$$

and substituting (2.2.18) into (2.2.19) yields

$$g(f(x_0)) = x_0.$$

Dropping the subscripts in these two equations yields (2.2.16) and (2.2.17).

The uniqueness of  $g$  follows from our assumption that  $f$  is increasing, and therefore only one value of  $x_0$  can satisfy (2.2.18) for each  $y_0$ .

To see that  $g$  is increasing, suppose that  $y_1 < y_2$  and let  $x_1$  and  $x_2$  be the points in  $[a, b]$  such that  $f(x_1) = y_1$  and  $f(x_2) = y_2$ . Since  $f$  is increasing,  $x_1 < x_2$ . Therefore,

$$g(y_1) = x_1 < x_2 = g(y_2),$$

so  $g$  is increasing. Since  $R_g = \{g(y) \mid y \in [c, d]\}$  is the interval  $[g(c), g(d)] = [a, b]$ , Theorem 2.2.14 with  $f$  and  $[a, b]$  replaced by  $g$  and  $[c, d]$  implies that  $g$  is continuous on  $[c, d]$ . ■

The function  $g$  of Theorem 2.2.15 is the *inverse* of  $f$ , denoted by  $f^{-1}$ . Since (2.2.16) and (2.2.17) are symmetric in  $f$  and  $g$ , we can also regard  $f$  as the inverse of  $g$ , and denote it by  $g^{-1}$ .

**Example 2.2.17** If

$$f(x) = x^2, \quad 0 \leq x \leq R,$$

then

$$f^{-1}(y) = g(y) = \sqrt{y}, \quad 0 \leq y \leq R^2.$$

**Example 2.2.18** If

$$f(x) = 2x + 4, \quad 0 \leq x \leq 2,$$

then

$$f^{-1}(y) = g(y) = \frac{y-4}{2}, \quad 4 \leq y \leq 8.$$

## 2.2 Exercises

1. Prove Theorem 2.2.2.
2. Prove that a function  $f$  is continuous at  $x_0$  if and only if

$$\lim_{x \rightarrow x_0^-} f(x) = \lim_{x \rightarrow x_0^+} f(x) = f(x_0).$$

3. Determine whether  $f$  is continuous or discontinuous from the right or left at  $x_0$ .

(a)  $f(x) = \sqrt{x}$  ( $x_0 = 0$ )    (b)  $f(x) = \sqrt{x}$  ( $x_0 > 0$ )

(c)  $f(x) = \frac{1}{x}$  ( $x_0 = 0$ )    (d)  $f(x) = x^2$  ( $x_0$  arbitrary)

(e)  $f(x) = \begin{cases} x \sin 1/x, & x \neq 0, \\ 1, & x = 0 \end{cases}$  ( $x_0 = 0$ )

(f)  $f(x) = \begin{cases} x \sin 1/x, & x \neq 0 \\ 0, & x = 0 \end{cases}$  ( $x_0 = 0$ )

(g)  $f(x) = \begin{cases} \frac{x + |x|(1+x)}{x} \sin \frac{1}{x}, & x \neq 0 \\ 1, & x = 0 \end{cases}$  ( $x_0 = 0$ )

4. Let  $f$  be defined on  $[0, 2]$  by

$$f(x) = \begin{cases} x^2, & 0 \leq x < 1, \\ x + 1, & 1 \leq x \leq 2. \end{cases}$$

On which of the following intervals is  $f$  continuous according to Definition 2.2.3:  $[0, 1)$ ,  $(0, 1)$ ,  $(0, 1]$ ,  $[0, 1]$ ,  $[1, 2)$ ,  $(1, 2)$ ,  $(1, 2]$ ,  $[1, 2]$ ?

5. Let

$$g(x) = \frac{\sqrt{x}}{x-1}.$$

On which of the following intervals is  $g$  continuous according to Definition 2.2.3:  $[0, 1)$ ,  $(0, 1)$ ,  $(0, 1]$ ,  $[1, \infty)$ ,  $(1, \infty)$ ?

6. Let

$$f(x) = \begin{cases} -1 & \text{if } x \text{ is irrational,} \\ 1 & \text{if } x \text{ is rational.} \end{cases}$$

Show that  $f$  is not continuous anywhere.

7. Let  $f(x) = 0$  if  $x$  is irrational and  $f(p/q) = 1/q$  if  $p$  and  $q$  are positive integers with no common factors. Show that  $f$  is discontinuous at every rational and continuous at every irrational on  $(0, \infty)$ .
8. Prove: If  $f$  assumes only finitely many values, then  $f$  is continuous at a point  $x_0$  in  $D_f^0$  if and only if  $f$  is constant on some interval  $(x_0 - \delta, x_0 + \delta)$ .
9. The *characteristic function*  $\psi_T$  of a set  $T$  is defined by

$$\psi_T(x) = \begin{cases} 1, & x \in T, \\ 0, & x \notin T. \end{cases}$$

Show that  $\psi_T$  is continuous at a point  $x_0$  if and only if  $x_0 \in T^0 \cup (T^c)^0$ .

10. Prove: If  $f$  and  $g$  are continuous on  $(a, b)$  and  $f(x) = g(x)$  for every  $x$  in a dense subset (Definition 1.1.5) of  $(a, b)$ , then  $f(x) = g(x)$  for all  $x$  in  $(a, b)$ .
11. Prove that the function  $g(x) = \log x$  is continuous on  $(0, \infty)$ . Take the following properties as given.
- (a)  $\lim_{x \rightarrow 1} g(x) = 0$ .
- (b)  $g(x_1) + g(x_2) = g(x_1 x_2)$  if  $x_1, x_2 > 0$ .
12. Prove that the function  $f(x) = e^{ax}$  is continuous on  $(-\infty, \infty)$ . Take the following properties as given.
- (a)  $\lim_{x \rightarrow 0} f(x) = 1$ .
- (b)  $f(x_1 + x_2) = f(x_1)f(x_2)$ ,  $-\infty < x_1, x_2 < \infty$ .
13. (a) Prove that the functions  $\sinh x$  and  $\cosh x$  are continuous for all  $x$ .
- (b) For what values of  $x$  are  $\tanh x$  and  $\coth x$  continuous?
14. Prove that the functions  $s(x) = \sin x$  and  $c(x) = \cos x$  are continuous on  $(-\infty, \infty)$ . Take the following properties as given.
- (a)  $\lim_{x \rightarrow 0} c(x) = 1$ .
- (b)  $c(x_1 - x_2) = c(x_1)c(x_2) + s(x_1)s(x_2)$ ,  $-\infty < x_1, x_2 < \infty$ .
- (c)  $s^2(x) + c^2(x) = 1$ ,  $-\infty < x < \infty$ .
15. (a) Prove: If  $f$  is continuous at  $x_0$  and  $f(x_0) > \mu$ , then  $f(x) > \mu$  for all  $x$  in some neighborhood of  $x_0$ .
- (b) State a result analogous to (a) for the case where  $f(x_0) < \mu$ .
- (c) Prove: If  $f(x) \leq \mu$  for all  $x$  in  $S$  and  $x_0$  is a limit point of  $S$  at which  $f$  is continuous, then  $f(x_0) \leq \mu$ .
- (d) State results analogous to (a), (b), and (c) for the case where  $f$  is continuous from the right or left at  $x_0$ .

16. Let  $|f|$  be the function whose value at each  $x$  in  $D_f$  is  $|f(x)|$ . Prove: If  $f$  is continuous at  $x_0$ , then so is  $|f|$ . Is the converse true?
17. Prove: If  $f$  is monotonic on  $[a, b]$ , then  $f$  is piecewise continuous on  $[a, b]$  if and only if  $f$  has only finitely many discontinuities in  $[a, b]$ .
18. Prove Theorem 2.2.5.
19. (a) Show that if  $f_1, f_2, \dots, f_n$  are continuous on a set  $S$  then so are  $f_1 + f_2 + \dots + f_n$  and  $f_1 f_2 \dots f_n$ .  
 (b) Use (a) to show that a rational function is continuous for all values of  $x$  except the zeros of its denominator.
20. (a) Let  $f_1$  and  $f_2$  be continuous at  $x_0$  and define

$$F(x) = \max(f_1(x), f_2(x)).$$

Show that  $F$  is continuous at  $x_0$ .

- (b) Let  $f_1, f_2, \dots, f_n$  be continuous at  $x_0$  and define

$$F(x) = \max(f_1(x), f_2(x), \dots, f_n(x)).$$

Show that  $F$  is continuous at  $x_0$ .

21. Find the domains of  $f \circ g$  and  $g \circ f$ .  
 (a)  $f(x) = \sqrt{x}$ ,  $g(x) = 1 - x^2$       (b)  $f(x) = \log x$ ,  $g(x) = \sin x$   
 (c)  $f(x) = \frac{1}{1 - x^2}$ ,  $g(x) = \cos x$       (d)  $f(x) = \sqrt{x}$ ,  $g(x) = \sin 2x$
22. (a) Suppose that  $y_0 = \lim_{x \rightarrow x_0} g(x)$  exists and is an interior point of  $D_f$ , and that  $f$  is continuous at  $y_0$ . Show that

$$\lim_{x \rightarrow x_0} (f \circ g)(x) = f(y_0).$$

- (b) State an analogous result for limits from the right.  
 (c) State an analogous result for limits from the left.

23. Use Theorem 2.2.7 to find all points  $x_0$  at which the following functions are continuous.

- (a)  $\sqrt{1 - x^2}$       (b)  $\sin e^{-x^2}$       (c)  $\log(1 + \sin x)$   
 (d)  $e^{-1/(1-2x)}$       (e)  $\sin \frac{1}{(x-1)^2}$       (f)  $\sin \left( \frac{1}{\cos x} \right)$   
 (g)  $(1 - \sin^2 x)^{-1/2}$       (h)  $\cot(1 - e^{-x^2})$       (i)  $\cos \frac{1}{x}$

24. Complete the proof of Theorem 2.2.9 by showing that there is an  $x_2$  such that  $f(x_2) = \beta$ .

25. Prove: If  $f$  is nonconstant and continuous on an interval  $I$ , then the set  $S = \{y \mid y = f(x), x \in I\}$  is an interval. Moreover, if  $I$  is a finite closed interval, then so is  $S$ .
26. Suppose that  $f$  and  $g$  are defined on  $(-\infty, \infty)$ ,  $f$  is increasing, and  $f \circ g$  is continuous on  $(-\infty, \infty)$ . Show that  $g$  is continuous on  $(-\infty, \infty)$ .
27. Let  $f$  be continuous on  $[a, b)$ , and define

$$F(x) = \max_{a \leq t \leq x} f(t), \quad a \leq x < b.$$

(How do we know that  $F$  is well defined?) Show that  $F$  is continuous on  $[a, b)$ .

28. Let  $f$  and  $g$  be uniformly continuous on an interval  $S$ .
- Show that  $f + g$  and  $f - g$  are uniformly continuous on  $S$ .
  - Show that  $fg$  is uniformly continuous on  $S$  if  $S$  is compact.
  - Show that  $f/g$  is uniformly continuous on  $S$  if  $S$  is compact and  $g$  has no zeros in  $S$ .
  - Give examples showing that the conclusion of (b) and (c) may fail to hold if  $S$  is not compact.
  - State additional conditions on  $f$  and  $g$  which guarantee that  $fg$  is uniformly continuous on  $S$  even if  $S$  is not compact. Do the same for  $f/g$ .
29. Suppose that  $f$  is uniformly continuous on a set  $S$ ,  $g$  is uniformly continuous on a set  $T$ , and  $g(x) \in S$  for every  $x$  in  $T$ . Show that  $f \circ g$  is uniformly continuous on  $T$ .
30. (a) Prove: If  $f$  is uniformly continuous on disjoint closed intervals  $I_1, I_2, \dots, I_n$ , then  $f$  is uniformly continuous on  $\bigcup_{j=1}^n I_j$ .
- (b) Is (a) valid without the word “closed”?
31. (a) Prove: If  $f$  is uniformly continuous on a bounded open interval  $(a, b)$ , then  $f(a+)$  and  $f(b-)$  exist and are finite. HINT: See Exercise 2.1.38.
- (b) Show that the conclusion in (a) does not follow if  $(a, b)$  is unbounded.
32. Prove: If  $f$  is continuous on  $[a, \infty)$  and  $f(\infty)$  exists (finite), then  $f$  is uniformly continuous on  $[a, \infty)$ .
33. Suppose that  $f$  is defined on  $(-\infty, \infty)$  and has the following properties.
- $\lim_{x \rightarrow 0} f(x) = 1$  and
  - $f(x_1 + x_2) = f(x_1)f(x_2), \quad -\infty < x_1, x_2 < \infty.$

Prove:

- $f(x) > 0$  for all  $x$ .
- $f(rx) = [f(x)]^r$  if  $r$  is rational.
- If  $f(1) = 1$  then  $f$  is constant.



(d) If  $f(1) = \rho > 1$ , then  $f$  is increasing,

$$\lim_{x \rightarrow \infty} f(x) = \infty, \quad \text{and} \quad \lim_{x \rightarrow -\infty} f(x) = 0.$$

(Thus,  $f(x) = e^{ax}$  has these properties if  $a > 0$ .)

HINT: See Exercises 2.2.10 and 2.2.12.

34. Prove Theorem 2.2.14 in the case where  $f$  is nonincreasing.

## 2.3 DIFFERENTIABLE FUNCTIONS OF ONE VARIABLE

In calculus you studied differentiation, emphasizing rules for calculating derivatives. Here we consider the theoretical properties of differentiable functions. In doing this, we assume that you know how to differentiate elementary functions such as  $x^n$ ,  $e^x$ , and  $\sin x$ , and we will use such functions in examples.

### Definition of the Derivative

**Definition 2.3.1** A function  $f$  is *differentiable* at an interior point  $x_0$  of its domain if the difference quotient

$$\frac{f(x) - f(x_0)}{x - x_0}, \quad x \neq x_0,$$

approaches a limit as  $x$  approaches  $x_0$ , in which case the limit is called the *derivative of  $f$  at  $x_0$* , and is denoted by  $f'(x_0)$ ; thus,

$$f'(x_0) = \lim_{x \rightarrow x_0} \frac{f(x) - f(x_0)}{x - x_0}. \quad (2.3.1)$$

It is sometimes convenient to let  $x = x_0 + h$  and write (2.3.1) as

$$f'(x_0) = \lim_{h \rightarrow 0} \frac{f(x_0 + h) - f(x_0)}{h}. \quad \blacksquare$$

If  $f$  is defined on an open set  $S$ , we say that  $f$  is *differentiable on  $S$*  if  $f$  is differentiable at every point of  $S$ . If  $f$  is differentiable on  $S$ , then  $f'$  is a function on  $S$ . We say that  $f$  is *continuously differentiable* on  $S$  if  $f'$  is continuous on  $S$ . If  $f$  is differentiable on a neighborhood of  $x_0$ , it is reasonable to ask if  $f'$  is differentiable at  $x_0$ . If so, we denote the derivative of  $f'$  at  $x_0$  by  $f''(x_0)$ . This is the *second derivative of  $f$  at  $x_0$* , and it is also denoted by  $f^{(2)}(x_0)$ . Continuing inductively, if  $f^{(n-1)}$  is defined on a neighborhood of  $x_0$ , then the  *$n$ th derivative of  $f$  at  $x_0$* , denoted by  $f^{(n)}(x_0)$ , is the derivative of  $f^{(n-1)}$  at  $x_0$ . For convenience we define the *zeroth derivative* of  $f$  to be  $f$  itself; thus

$$f^{(0)} = f.$$

We assume that you are familiar with the other standard notations for derivatives; for example,

$$f^{(2)} = f'', \quad f^{(3)} = f''',$$

and so on, and

$$\frac{d^n f}{dx^n} = f^{(n)}.$$

**Example 2.3.1** If  $n$  is a positive integer and

$$f(x) = x^n,$$

then

$$\frac{f(x) - f(x_0)}{x - x_0} = \frac{x^n - x_0^n}{x - x_0} = \frac{x - x_0}{x - x_0} \sum_{k=0}^{n-1} x^{n-k-1} x_0^k,$$

so

$$f'(x_0) = \lim_{x \rightarrow x_0} \sum_{k=0}^{n-1} x^{n-k-1} x_0^k = nx_0^{n-1}.$$

Since this holds for every  $x_0$ , we drop the subscript and write

$$f'(x) = nx^{n-1} \quad \text{or} \quad \frac{d}{dx}(x^n) = nx^{n-1}. \quad \blacksquare$$

To derive differentiation formulas for elementary functions such as  $\sin x$ ,  $\cos x$ , and  $e^x$  directly from Definition 2.3.1 requires estimates based on the properties of these functions. Since this is done in calculus, we will not repeat it here.

### Interpretations of the Derivative

If  $f(x)$  is the position of a particle at time  $x \neq x_0$ , the difference quotient

$$\frac{f(x) - f(x_0)}{x - x_0}$$

is the average velocity of the particle between times  $x_0$  and  $x$ . As  $x$  approaches  $x_0$ , the average applies to shorter and shorter intervals. Therefore, it makes sense to regard the limit (2.3.1), if it exists, as the particle's *instantaneous velocity at time  $x_0$* . This interpretation may be useful even if  $x$  is not time, so we often regard  $f'(x_0)$  as the *instantaneous rate of change of  $f(x)$  at  $x_0$* , regardless of the specific nature of the variable  $x$ . The derivative also has a geometric interpretation. The equation of the line through two points  $(x_0, f(x_0))$  and  $(x_1, f(x_1))$  on the curve  $y = f(x)$  (Figure 2.3.1) is

$$y = f(x_0) + \frac{f(x_1) - f(x_0)}{x_1 - x_0}(x - x_0).$$

Varying  $x_1$  generates lines through  $(x_0, f(x_0))$  that rotate into the line

$$y = f(x_0) + f'(x_0)(x - x_0) \tag{2.3.2}$$

as  $x_1$  approaches  $x_0$ . This is the *tangent* to the curve  $y = f(x)$  at the point  $(x_0, f(x_0))$ . Figure 2.3.2 depicts the situation for various values of  $x_1$ .

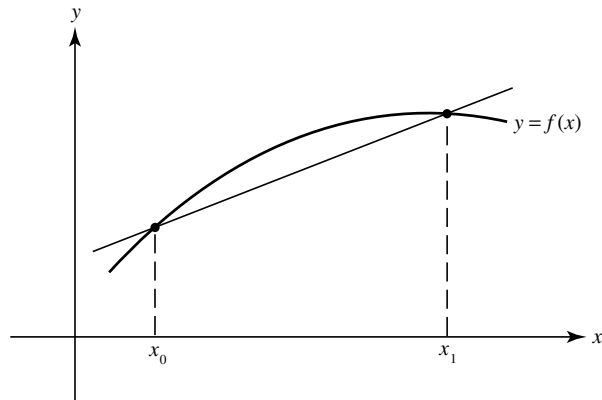


Figure 2.3.1

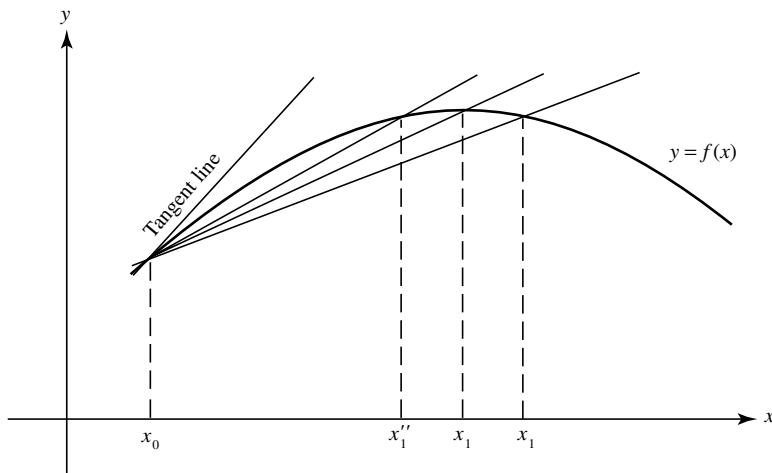


Figure 2.3.2

Here is a less intuitive definition of the tangent line: If the function

$$T(x) = f(x_0) + m(x - x_0)$$

approximates  $f$  so well near  $x_0$  that

$$\lim_{x \rightarrow x_0} \frac{f(x) - T(x)}{x - x_0} = 0,$$

we say that the line  $y = T(x)$  is *tangent to the curve*  $y = f(x)$  at  $(x_0, f(x_0))$ .

This tangent line exists if and only if  $f'(x_0)$  exists, in which case  $m$  is uniquely determined by  $m = f'(x_0)$  (Exercise 2.3.1). Thus, (2.3.2) is the equation of the tangent line.

We will use the following lemma to study differentiable functions.

**Lemma 2.3.2** *If  $f$  is differentiable at  $x_0$ , then*

$$f(x) = f(x_0) + [f'(x_0) + E(x)](x - x_0), \quad (2.3.3)$$

where  $E$  is defined on a neighborhood of  $x_0$  and

$$\lim_{x \rightarrow x_0} E(x) = E(x_0) = 0.$$

**Proof** Define

$$E(x) = \begin{cases} \frac{f(x) - f(x_0)}{x - x_0} - f'(x_0), & x \in D_f \text{ and } x \neq x_0, \\ 0, & x = x_0. \end{cases} \quad (2.3.4)$$

Solving (2.3.4) for  $f(x)$  yields (2.3.3) if  $x \neq x_0$ , and (2.3.3) is obvious if  $x = x_0$ . Definition 2.3.1 implies that  $\lim_{x \rightarrow x_0} E(x) = 0$ . We defined  $E(x_0) = 0$  to make  $E$  continuous at  $x_0$ . ■

Since the right side of (2.3.3) is continuous at  $x_0$ , so is the left. This yields the following theorem.

**Theorem 2.3.3** *If  $f$  is differentiable at  $x_0$ , then  $f$  is continuous at  $x_0$ .*

The converse of this theorem is false, since a function may be continuous at a point without being differentiable at the point.

**Example 2.3.2** The function

$$f(x) = |x|$$

can be written as

$$f(x) = x, \quad x > 0, \quad (2.3.5)$$

or as

$$f(x) = -x, \quad x < 0. \quad (2.3.6)$$

From (2.3.5),

$$f'(x) = 1, \quad x > 0,$$

and from (2.3.6),

$$f'(x) = -1, \quad x < 0.$$

Neither (2.3.5) nor (2.3.6) holds throughout any neighborhood of 0, so neither can be used alone to calculate  $f'(0)$ . In fact, since the one-sided limits

$$\lim_{x \rightarrow 0^+} \frac{f(x) - f(0)}{x - 0} = \lim_{x \rightarrow 0^+} \frac{x}{x} \quad (2.3.7)$$

and

$$\lim_{x \rightarrow 0^-} \frac{f(x) - f(0)}{x - 0} = \lim_{x \rightarrow 0^-} \frac{-x}{x} = -1 \quad (2.3.8)$$

are different,

$$\lim_{x \rightarrow 0} \frac{f(x) - f(0)}{x - 0}$$

does not exist (Theorem 2.1.6); thus,  $f$  is not differentiable at 0, even though it is continuous at 0.

## Interchanging Differentiation and Arithmetic Operations

The following theorem should be familiar from calculus.

**Theorem 2.3.4** *If  $f$  and  $g$  are differentiable at  $x_0$ , then so are  $f + g$ ,  $f - g$ , and  $fg$ , with*

- (a)  $(f + g)'(x_0) = f'(x_0) + g'(x_0)$ ;
- (b)  $(f - g)'(x_0) = f'(x_0) - g'(x_0)$ ;
- (c)  $(fg)'(x_0) = f'(x_0)g(x_0) + f(x_0)g'(x_0)$ .

*The quotient  $f/g$  is differentiable at  $x_0$  if  $g(x_0) \neq 0$ , with*

$$(d) \left(\frac{f}{g}\right)'(x_0) = \frac{f'(x_0)g(x_0) - f(x_0)g'(x_0)}{[g(x_0)]^2}.$$

**Proof** The proof is accomplished by forming the appropriate difference quotients and applying Definition 2.3.1 and Theorem 2.1.4. We will prove (c) and leave the rest to you (Exercises 2.3.9, 2.3.10, and 2.3.11).

The trick is to add and subtract the right quantity in the numerator of the difference quotient for  $(fg)'(x_0)$ ; thus,

$$\begin{aligned} \frac{f(x)g(x) - f(x_0)g(x_0)}{x - x_0} &= \frac{f(x)g(x) - f(x_0)g(x) + f(x_0)g(x) - f(x_0)g(x_0)}{x - x_0} \\ &= \frac{f(x) - f(x_0)}{x - x_0}g(x) + f(x_0)\frac{g(x) - g(x_0)}{x - x_0}. \end{aligned}$$

The difference quotients on the right approach  $f'(x_0)$  and  $g'(x_0)$  as  $x$  approaches  $x_0$ , and  $\lim_{x \rightarrow x_0} g(x) = g(x_0)$  (Theorem 2.3.3). This proves (c). ■

## The Chain Rule

Here is the rule for differentiating a composite function.

**Theorem 2.3.5 (The Chain Rule)** *Suppose that  $g$  is differentiable at  $x_0$  and  $f$  is differentiable at  $g(x_0)$ . Then the composite function  $h = f \circ g$ , defined by*

$$h(x) = f(g(x)),$$

*is differentiable at  $x_0$ , with*

$$h'(x_0) = f'(g(x_0))g'(x_0).$$

**Proof** Since  $f$  is differentiable at  $g(x_0)$ , Lemma 2.3.2 implies that

$$f(t) - f(g(x_0)) = [f'(g(x_0)) + E(t)][t - g(x_0)],$$

where

$$\lim_{t \rightarrow g(x_0)} E(t) = E(g(x_0)) = 0. \quad (2.3.9)$$

Letting  $t = g(x)$  yields

$$f(g(x)) - f(g(x_0)) = [f'(g(x_0)) + E(g(x))][g(x) - g(x_0)].$$

Since  $h(x) = f(g(x))$ , this implies that

$$\frac{h(x) - h(x_0)}{x - x_0} = [f'(g(x_0)) + E(g(x))] \frac{g(x) - g(x_0)}{x - x_0}. \quad (2.3.10)$$

Since  $g$  is continuous at  $x_0$  (Theorem 2.3.3), (2.3.9) and Theorem 2.2.7 imply that

$$\lim_{x \rightarrow x_0} E(g(x)) = E(g(x_0)) = 0.$$

Therefore, (2.3.10) implies that

$$h'(x_0) = \lim_{x \rightarrow x_0} \frac{h(x) - h(x_0)}{x - x_0} = f'(g(x_0))g'(x_0),$$

as stated. ■

**Example 2.3.3** If

$$f(x) = \sin x \quad \text{and} \quad g(x) = \frac{1}{x}, \quad x \neq 0,$$

then

$$h(x) = f(g(x)) = \sin \frac{1}{x}, \quad x \neq 0,$$

and

$$h'(x) = f'(g(x))g'(x) = \left(\cos \frac{1}{x}\right) \left(-\frac{1}{x^2}\right), \quad x \neq 0. \quad \blacksquare$$

It may seem reasonable to justify the chain rule by writing

$$\begin{aligned} \frac{h(x) - h(x_0)}{x - x_0} &= \frac{f(g(x)) - f(g(x_0))}{x - x_0} \\ &= \frac{f(g(x)) - f(g(x_0))}{g(x) - g(x_0)} \frac{g(x) - g(x_0)}{x - x_0} \end{aligned}$$

and arguing that

$$\lim_{x \rightarrow x_0} \frac{f(g(x)) - f(g(x_0))}{g(x) - g(x_0)} = f'(g(x_0))$$

(because  $\lim_{x \rightarrow x_0} g(x) = g(x_0)$ ) and

$$\lim_{x \rightarrow x_0} \frac{g(x) - g(x_0)}{x - x_0} = g'(x_0).$$

However, this is not a valid proof (Exercise 2.3.13).

### One-Sided Derivatives

One-sided limits of difference quotients such as (2.3.7) and (2.3.8) in Example 2.3.2 are called *one-sided* or *right- and left-hand derivatives*. That is, if  $f$  is defined on  $[x_0, b)$ , the *right-hand derivative of  $f$  at  $x_0$*  is defined to be

$$f'_+(x_0) = \lim_{x \rightarrow x_0^+} \frac{f(x) - f(x_0)}{x - x_0}$$

if the limit exists, while if  $f$  is defined on  $(a, x_0]$ , the *left-hand derivative of  $f$  at  $x_0$*  is defined to be

$$f'_-(x_0) = \lim_{x \rightarrow x_0^-} \frac{f(x) - f(x_0)}{x - x_0}$$

if the limit exists. Theorem 2.1.6 implies that  $f$  is differentiable at  $x_0$  if and only if  $f'_+(x_0)$  and  $f'_-(x_0)$  exist and are equal, in which case

$$f'(x_0) = f'_+(x_0) = f'_-(x_0).$$

In Example 2.3.2,  $f'_+(0) = 1$  and  $f'_-(0) = -1$ .

### Example 2.3.4

$$f(x) = \begin{cases} x^3, & x \leq 0, \\ x^2 \sin \frac{1}{x}, & x > 0, \end{cases} \quad (2.3.11)$$

then

$$f'(x) = \begin{cases} 3x^2, & x < 0, \\ 2x \sin \frac{1}{x} - \cos \frac{1}{x}, & x > 0. \end{cases} \quad (2.3.12)$$

Since neither formula in (2.3.11) holds for all  $x$  in any neighborhood of 0, we cannot simply differentiate either to obtain  $f'(0)$ ; instead, we calculate

$$f'_+(0) = \lim_{x \rightarrow 0^+} \frac{x^2 \sin \frac{1}{x} - 0}{x - 0} = \lim_{x \rightarrow 0^+} x \sin \frac{1}{x} = 0,$$

$$f'_-(0) = \lim_{x \rightarrow 0^-} \frac{x^3 - 0}{x - 0} = \lim_{x \rightarrow 0^-} x^2 = 0;$$

hence,  $f'(0) = f'_+(0) = f'_-(0) = 0$ . ■

This example shows that there is a difference between a one-sided derivative and a one-sided limit of a derivative, since  $f'_+(0) = 0$ , but, from (2.3.12),  $f'(0+) = \lim_{x \rightarrow 0+} f'(x)$  does not exist. It also shows that a derivative may exist in a neighborhood of a point  $x_0$  ( $= 0$  in this case), but be discontinuous at  $x_0$ .

Exercise 2.3.4 justifies the method used in Example 2.3.4 to compute  $f'(x)$  for  $x \neq 0$ .

### Definition 2.3.6

- (a) We say that  $f$  is *differentiable on the closed interval*  $[a, b]$  if  $f$  is differentiable on the open interval  $(a, b)$  and  $f'_+(a)$  and  $f'_-(b)$  both exist.
- (b) We say that  $f$  is *continuously differentiable on*  $[a, b]$  if  $f$  is differentiable on  $[a, b]$ ,  $f'$  is continuous on  $(a, b)$ ,  $f'_+(a) = f'(a+)$ , and  $f'_-(b) = f'(b-)$ .

### Extreme Values

We say that  $f(x_0)$  is a *local extreme value* of  $f$  if there is a  $\delta > 0$  such that  $f(x) - f(x_0)$  does not change sign on

$$(x_0 - \delta, x_0 + \delta) \cap D_f. \quad (2.3.13)$$

More specifically,  $f(x_0)$  is a *local maximum value* of  $f$  if

$$f(x) \leq f(x_0) \quad (2.3.14)$$

or a *local minimum value* of  $f$  if

$$f(x) \geq f(x_0) \quad (2.3.15)$$

for all  $x$  in the set (2.3.13). The point  $x_0$  is called a *local extreme point* of  $f$ , or, more specifically, a *local maximum* or *local minimum point* of  $f$ .

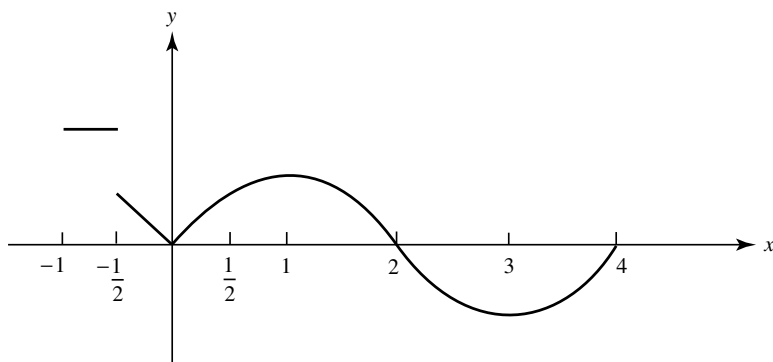


Figure 2.3.3



**Example 2.3.5** If

$$f(x) = \begin{cases} 1, & -1 < x \leq -\frac{1}{2} \\ |x|, & -\frac{1}{2} < x \leq \frac{1}{2}, \\ \frac{1}{\sqrt{2}} \sin \frac{\pi x}{2}, & \frac{1}{2} < x \leq 4 \end{cases}$$

(Figure 2.3.3), then 0, 3, and every  $x$  in  $(-1, -\frac{1}{2})$  are local minimum points of  $f$ , while 1, 4, and every  $x$  in  $(-\frac{1}{2}, \frac{1}{2}]$  are local maximum points. ■

It is geometrically plausible that if the curve  $y = f(x)$  has a tangent at a local extreme point of  $f$ , then the tangent must be horizontal; that is, have zero slope. (For example, in Figure 2.3.3, see  $x = 1$ ,  $x = 3$ , and every  $x$  in  $(-1, -1/2)$ .) The following theorem shows that this must be so.

**Theorem 2.3.7** *If  $f$  is differentiable at a local extreme point  $x_0 \in D_f^0$ , then  $f'(x_0) = 0$ .*

**Proof** We will show that  $x_0$  is not a local extreme point of  $f$  if  $f'(x_0) \neq 0$ . From Lemma 2.3.2,

$$\frac{f(x) - f(x_0)}{x - x_0} = f'(x_0) + E(x), \quad (2.3.16)$$

where  $\lim_{x \rightarrow x_0} E(x) = 0$ . Therefore, if  $f'(x_0) \neq 0$ , there is a  $\delta > 0$  such that

$$|E(x)| < |f'(x_0)| \quad \text{if} \quad |x - x_0| < \delta,$$

and the right side of (2.3.16) must have the same sign as  $f'(x_0)$  for  $|x - x_0| < \delta$ . Since the same is true of the left side,  $f(x) - f(x_0)$  must change sign in every neighborhood of  $x_0$  (since  $x - x_0$  does). Therefore, neither (2.3.14) nor (2.3.15) can hold for all  $x$  in any interval about  $x_0$ . ■

If  $f'(x_0) = 0$ , we say that  $x_0$  is a *critical point* of  $f$ . Theorem 2.3.7 says that every local extreme point of  $f$  at which  $f$  is differentiable is a critical point of  $f$ . The converse is false. For example, 0 is a critical point of  $f(x) = x^3$ , but not a local extreme point.

### Rolle's Theorem

The use of Theorem 2.3.7 for finding local extreme points is covered in calculus, so we will not pursue it here. However, we will use Theorem 2.3.7 to prove the following fundamental theorem, which says that if a curve  $y = f(x)$  intersects a horizontal line at  $x = a$  and  $x = b$  and has a tangent at  $(x, f(x))$  for every  $x$  in  $(a, b)$ , then there is a point  $c$  in  $(a, b)$  such that the tangent to the curve at  $(c, f(c))$  is horizontal (Figure 2.3.4).

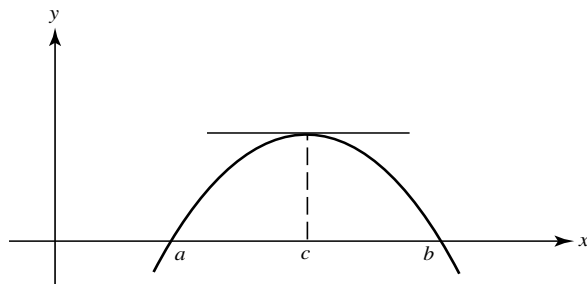


Figure 2.3.4

**Theorem 2.3.8 (Rolle's Theorem)** Suppose that  $f$  is continuous on the closed interval  $[a, b]$  and differentiable on the open interval  $(a, b)$ , and  $f(a) = f(b)$ . Then  $f'(c) = 0$  for some  $c$  in the open interval  $(a, b)$ .

**Proof** Since  $f$  is continuous on  $[a, b]$ ,  $f$  attains a maximum and a minimum value on  $[a, b]$  (Theorem 2.2.9). If these two extreme values are the same, then  $f$  is constant on  $(a, b)$ , so  $f'(x) = 0$  for all  $x$  in  $(a, b)$ . If the extreme values differ, then at least one must be attained at some point  $c$  in the open interval  $(a, b)$ , and  $f'(c) = 0$ , by Theorem 2.3.7.

■

### Intermediate Values of Derivatives

A derivative may exist on an interval  $[a, b]$  without being continuous on  $[a, b]$ . Nevertheless, an intermediate value theorem similar to Theorem 2.2.10 applies to derivatives.

**Theorem 2.3.9 (Intermediate Value Theorem for Derivatives)** Suppose that  $f$  is differentiable on  $[a, b]$ ,  $f'(a) \neq f'(b)$ , and  $\mu$  is between  $f'(a)$  and  $f'(b)$ . Then  $f'(c) = \mu$  for some  $c$  in  $(a, b)$ .

**Proof** Suppose first that

$$f'(a) < \mu < f'(b) \quad (2.3.17)$$

and define

$$g(x) = f(x) - \mu x.$$

Then

$$g'(x) = f'(x) - \mu, \quad a \leq x \leq b, \quad (2.3.18)$$

and (2.3.17) implies that

$$g'(a) < 0 \quad \text{and} \quad g'(b) > 0. \quad (2.3.19)$$

Since  $g$  is continuous on  $[a, b]$ ,  $g$  attains a minimum at some point  $c$  in  $[a, b]$ . Lemma 2.3.2 and (2.3.19) imply that there is a  $\delta > 0$  such that

$$g(x) < g(a), \quad a < x < a + \delta, \quad \text{and} \quad g(x) < g(b), \quad b - \delta < x < b$$

(Exercise 2.3.3), and therefore  $c \neq a$  and  $c \neq b$ . Hence,  $a < c < b$ , and therefore  $g'(c) = 0$ , by Theorem 2.3.7. From (2.3.18),  $f'(c) = \mu$ .

The proof for the case where  $f'(b) < \mu < f'(a)$  can be obtained by applying this result to  $-f$ . ■

## Mean Value Theorems

**Theorem 2.3.10 (Generalized Mean Value Theorem)** *If  $f$  and  $g$  are continuous on the closed interval  $[a, b]$  and differentiable on the open interval  $(a, b)$ , then*

$$[g(b) - g(a)]f'(c) = [f(b) - f(a)]g'(c) \quad (2.3.20)$$

for some  $c$  in  $(a, b)$ .

**Proof** The function

$$h(x) = [g(b) - g(a)]f(x) - [f(b) - f(a)]g(x)$$

is continuous on  $[a, b]$  and differentiable on  $(a, b)$ , and

$$h(a) = h(b) = g(b)f(a) - f(b)g(a).$$

Therefore, Rolle's theorem implies that  $h'(c) = 0$  for some  $c$  in  $(a, b)$ . Since

$$h'(c) = [g(b) - g(a)]f'(c) - [f(b) - f(a)]g'(c),$$

this implies (2.3.20). ■

The following special case of Theorem 2.3.10 is important enough to be stated separately.

**Theorem 2.3.11 (Mean Value Theorem)** *If  $f$  is continuous on the closed interval  $[a, b]$  and differentiable on the open interval  $(a, b)$ , then*

$$f'(c) = \frac{f(b) - f(a)}{b - a}$$

for some  $c$  in  $(a, b)$ .

**Proof** Apply Theorem 2.3.10 with  $g(x) = x$ . ■

Theorem 2.3.11 implies that the tangent to the curve  $y = f(x)$  at  $(c, f(c))$  is parallel to the line connecting the points  $(a, f(a))$  and  $(b, f(b))$  on the curve (Figure 2.3.5, page 84).

## Consequences of the Mean Value Theorem

If  $f$  is differentiable on  $(a, b)$  and  $x_1, x_2 \in (a, b)$  then  $f$  is continuous on the closed interval with endpoints  $x_1$  and  $x_2$  and differentiable on its interior. Hence, the mean value theorem implies that

$$f(x_2) - f(x_1) = f'(c)(x_2 - x_1)$$

for some  $c$  between  $x_1$  and  $x_2$ . (This is true whether  $x_1 < x_2$  or  $x_2 < x_1$ .) The next three theorems follow from this.

**Theorem 2.3.12** If  $f'(x) = 0$  for all  $x$  in  $(a, b)$ , then  $f$  is constant on  $(a, b)$ .

**Theorem 2.3.13** If  $f'$  exists and does not change sign on  $(a, b)$ , then  $f$  is monotonic on  $(a, b)$ : increasing, nondecreasing, decreasing, or nonincreasing as

$$f'(x) > 0, \quad f'(x) \geq 0, \quad f'(x) < 0, \quad \text{or} \quad f'(x) \leq 0,$$

respectively, for all  $x$  in  $(a, b)$ .

**Theorem 2.3.14** If

$$|f'(x)| \leq M, \quad a < x < b,$$

then

$$|f(x) - f(x')| \leq M|x - x'|, \quad x, x' \in (a, b). \quad (2.3.21)$$

A function that satisfies an inequality like (2.3.21) for all  $x$  and  $x'$  in an interval is said to satisfy a *Lipschitz condition* on the interval.

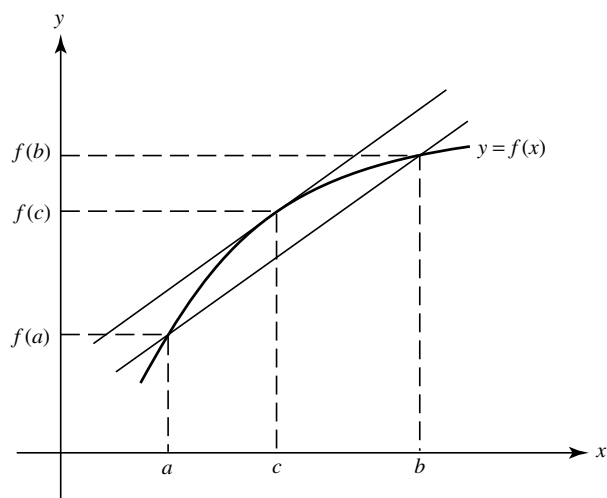


Figure 2.3.5

## 2.3 Exercises

1. Prove that a function  $f$  is differentiable at  $x_0$  if and only if

$$\lim_{x \rightarrow x_0} \frac{f(x) - f(x_0) - m(x - x_0)}{x - x_0} = 0$$

for some constant  $m$ . In this case,  $f'(x_0) = m$ .

2. Prove: If  $f$  is defined on a neighborhood of  $x_0$ , then  $f$  is differentiable at  $x_0$  if and only if the discontinuity of

$$h(x) = \frac{f(x) - f(x_0)}{x - x_0}$$

at  $x_0$  is removable.

3. Use Lemma 2.3.2 to prove that if  $f'(x_0) > 0$ , there is a  $\delta > 0$  such that

$$f(x) < f(x_0) \text{ if } x_0 - \delta < x < x_0 \text{ and } f(x) > f(x_0) \text{ if } x_0 < x < x_0 + \delta.$$

4. Suppose that  $p$  is continuous on  $(a, c]$  and differentiable on  $(a, c)$ , while  $q$  is continuous on  $[c, b)$  and differentiable on  $(c, b)$ . Let

$$f(x) = \begin{cases} p(x), & a < x \leq c, \\ q(x), & c < x < b. \end{cases}$$

- (a) Show that

$$f'(x) = \begin{cases} p'(x), & a < x < c, \\ q'(x), & c < x < b. \end{cases}$$

- (b) Under what additional conditions on  $p$  and  $q$  does  $f'(c)$  exist? Prove that your stated conditions are necessary and sufficient.

5. Find all derivatives of  $f(x) = x^{n-1}|x|$ , where  $n$  is a positive integer.
6. Suppose that  $f'(0)$  exists and  $f(x+y) = f(x)f(y)$  for all  $x$  and  $y$ . Prove that  $f'$  exists for all  $x$ .
7. Suppose that  $c'(0) = a$  and  $s'(0) = b$  where  $a^2 + b^2 \neq 0$ , and

$$c(x+y) = c(x)c(y) - s(x)s(y)$$

$$s(x+y) = s(x)c(y) + c(x)s(y)$$

for all  $x$  and  $y$ .

- (a) Show that  $c$  and  $s$  are differentiable on  $(-\infty, \infty)$ , and find  $c'$  and  $s'$  in terms of  $c$ ,  $s$ ,  $a$ , and  $b$ .
- (b) (For those who have studied differential equations.) Find  $c$  and  $s$  explicitly.
8. (a) Suppose that  $f$  and  $g$  are differentiable at  $x_0$ ,  $f(x_0) = g(x_0) = 0$ , and  $g'(x_0) \neq 0$ . Without using L'Hospital's rule, show that

$$\lim_{x \rightarrow x_0} \frac{f(x)}{g(x)} = \frac{f'(x_0)}{g'(x_0)}.$$

- (b) State the corresponding results for one-sided limits.

9. Prove Theorem 2.3.4(a).

10. Prove Theorem 2.3.4(b).  
 11. Prove Theorem 2.3.4(d).  
 12. Prove by induction: If  $n \geq 1$  and  $f^{(n)}(x_0)$  and  $g^{(n)}(x_0)$  exist, then so does  $(fg)^{(n)}(x_0)$ , and

$$(fg)^{(n)}(x_0) = \sum_{m=0}^n \binom{n}{m} f^{(m)}(x_0) g^{(n-m)}(x_0).$$

HINT: See Exercise 1.2.19. This is *Leibniz's rule* for differentiating a product.

13. What is wrong with the “proof” of the chain rule suggested after Example 2.3.3? Correct it.  
 14. Suppose that  $f$  is continuous and increasing on  $[a, b]$ . Let  $f$  be differentiable at a point  $x_0$  in  $(a, b)$ , with  $f'(x_0) \neq 0$ . If  $g$  is the inverse of  $f$  (Theorem 2.2.15), show that  $g'(f(x_0)) = 1/f'(x_0)$ .  
 15. (a) Show that  $f'_+(a) = f'(a+)$  if both quantities exist.  
 (b) Example 2.3.4 shows that  $f'_+(a)$  may exist even if  $f'(a+)$  does not. Give an example where  $f'(a+)$  exists but  $f'_+(a)$  does not.  
 (c) Complete the following statement so it becomes a theorem, and prove the theorem: “If  $f'(a+)$  exists and  $f$  is \_\_\_\_\_ at  $a$ , then  $f'_+(a) = f'(a+)$ .”  
 16. Show that  $f(a+)$  and  $f(b-)$  exist (finite) if  $f'$  is bounded on  $(a, b)$ . HINT: See Exercise 2.1.38.  
 17. Suppose that  $f$  is continuous on  $[a, b]$ ,  $f'_+(a)$  exists, and  $\mu$  is between  $f'_+(a)$  and  $(f(b) - f(a))/(b - a)$ . Show that  $f(c) - f(a) = \mu(c - a)$  for some  $c$  in  $(a, b)$ .  
 18. Suppose that  $f$  is continuous on  $[a, b]$ ,  $f'_+(a) < \mu < f'_-(b)$ , and

$$(f(b) - f(a))/(b - a) \neq \mu.$$

Show that either  $f(c) - f(a) = \mu(c - a)$  or  $f(c) - f(b) = \mu(c - b)$  for some  $c$  in  $(a, b)$ .

19. Let

$$f(x) = \frac{\sin x}{x}, \quad x \neq 0.$$

- (a) Define  $f(0)$  so that  $f$  is continuous at  $x = 0$ . HINT: Use Exercise 2.3.8.  
 (b) Show that if  $\bar{x}$  is a local extreme point of  $f$ , then

$$|f(\bar{x})| = (1 + \bar{x}^2)^{-1/2}.$$

HINT: Express  $\sin x$  and  $\cos x$  in terms of  $f(x)$  and  $f'(x)$ , and add their squares to obtain a useful identity.

- (c) Show that  $|f(x)| \leq 1$  for all  $x$ . For what value of  $x$  is equality attained?

20. Let  $n$  be a positive integer and

$$f(x) = \frac{\sin nx}{n \sin x}, \quad x \neq k\pi \quad (k = \text{integer}).$$

- (a) Define  $f(k\pi)$  so that  $f$  is continuous at  $k\pi$ . HINT: Use Exercise 2.3.8.  
 (b) Show that if  $\bar{x}$  is a local extreme point of  $f$ , then

$$|f(\bar{x})| = [1 + (n^2 - 1) \sin^2 \bar{x}]^{-1/2}.$$

HINT: Express  $\sin nx$  and  $\cos nx$  in terms of  $f(x)$  and  $f'(x)$ , and add their squares to obtain a useful identity.

- (c) Show that  $|f(x)| \leq 1$  for all  $x$ . For what values of  $x$  is equality attained?

21. We say that  $f$  has at least  $n$  zeros, counting multiplicities, on an interval  $I$  if there are distinct points  $x_1, x_2, \dots, x_p$  in  $I$  such that

$$f^{(j)}(x_i) = 0, \quad 0 \leq j \leq n_i - 1, \quad 1 \leq i \leq p,$$

and  $n_1 + \dots + n_p = n$ . Prove: If  $f$  is differentiable and has at least  $n$  zeros, counting multiplicities, on an interval  $I$ , then  $f'$  has at least  $n - 1$  zeros, counting multiplicities, on  $I$ .

22. Give an example of a function  $f$  such that  $f'$  exists on an interval  $(a, b)$  and has a jump discontinuity at a point  $x_0$  in  $(a, b)$ , or show that there is no such function.  
 23. Let  $x_1, x_2, \dots, x_n$  and  $y_1, y_2, \dots, y_n$  be in  $(a, b)$  and  $y_i < x_i$ ,  $1 \leq i \leq n$ . Show that if  $f$  is differentiable on  $(a, b)$ , then

$$\sum_{i=1}^n [f(x_i) - f(y_i)] = f'(c) \sum_{i=1}^n (x_i - y_i)$$

for some  $c$  in  $(a, b)$ .

24. Prove or give a counterexample: If  $f$  is differentiable on a neighborhood of  $x_0$ , then  $f$  satisfies a Lipschitz condition on some neighborhood of  $x_0$ .  
 25. Let

$$f''(x) + p(x)f(x) = 0 \quad \text{and} \quad g''(x) + p(x)g(x) = 0, \quad a < x < b.$$

- (a) Show that  $W = f'g - fg'$  is constant on  $(a, b)$ .  
 (b) Prove: If  $W \neq 0$  and  $f(x_1) = f(x_2) = 0$  where  $a < x_1 < x_2 < b$ , then  $g(c) = 0$  for some  $c$  in  $(x_1, x_2)$ . HINT: Consider  $f/g$ .

26. Suppose that we extend the definition of differentiability by saying that  $f$  is differentiable at  $x_0$  if

$$f'(x_0) = \lim_{x \rightarrow x_0} \frac{f(x) - f(x_0)}{x - x_0}$$

exists in the extended reals. Show that if

$$f(x) = \begin{cases} \sqrt{x}, & x \geq 0, \\ -\sqrt{-x}, & x < 0, \end{cases}$$

then  $f'(0) = \infty$ .

27. Prove or give a counterexample: If  $f$  is differentiable at  $x_0$  in the extended sense of Exercise 2.3.26, then  $f$  is continuous at  $x_0$ .
28. Assume that  $f$  is differentiable on  $(-\infty, \infty)$  and  $x_0$  is a critical point of  $f$ .
- (a) Let  $h(x) = f(x)g(x)$ , where  $g$  is differentiable on  $(-\infty, \infty)$  and

$$f(x_0)g'(x_0) \neq 0.$$

Show that the tangent line to the curve  $y = h(x)$  at  $(x_0, h(x_0))$  and the tangent line to the curve  $y = g(x)$  at  $(x_0, g(x_0))$  intersect on the  $x$ -axis.

- (b) Suppose that  $f(x_0) \neq 0$ . Let  $h(x) = f(x)(x - x_1)$ , where  $x_1$  is arbitrary. Show that the tangent line to the curve  $y = h(x)$  at  $(x_0, h(x_0))$  intersects the  $x$ -axis at  $\bar{x} = x_1$ .
- (c) Suppose that  $f(x_0) \neq 0$ . Let  $h(x) = f(x)(x - x_1)^2$ , where  $x_1 \neq x_0$ . Show that the tangent line to the curve  $y = h(x)$  at  $(x_0, h(x_0))$  intersects the  $x$ -axis at the midpoint of the interval with endpoints  $x_0$  and  $x_1$ .
- (d) Let  $h(x) = (ax^2 + bx + c)(x - x_1)$ , where  $a \neq 0$  and  $b^2 - 4ac \neq 0$ . Let  $x_0 = -\frac{b}{2a}$ . Show that the tangent line to the curve  $y = h(x)$  at  $(x_0, h(x_0))$  intersects the  $x$ -axis at  $\bar{x} = x_1$ .
- (e) Let  $h$  be a cubic polynomial with zeros  $\alpha$ ,  $\beta$ , and  $\gamma$ , where  $\alpha$  and  $\beta$  are distinct and  $\gamma$  is real. Let  $x_0 = \frac{\alpha + \beta}{2}$ . Show that the tangent line to the curve  $y = h(x)$  at  $(x_0, h(x_0))$  intersects the axis at  $\bar{x} = \gamma$ .

## 2.4 L'HOSPITAL'S RULE

The method of Theorem 2.1.4 for finding limits of the sum, difference, product, and quotient of functions breaks down in connection with indeterminate forms. The generalized mean value theorem (Theorem 2.3.10) leads to a method for evaluating limits of indeterminate forms.

**Theorem 2.4.1 (L'Hospital's Rule)** *Suppose that  $f$  and  $g$  are differentiable and  $g'$  has no zeros on  $(a, b)$ . Let*

$$\lim_{x \rightarrow b^-} f(x) = \lim_{x \rightarrow b^-} g(x) = 0 \tag{2.4.1}$$



or

$$\lim_{x \rightarrow b^-} f(x) = \pm\infty \quad \text{and} \quad \lim_{x \rightarrow b^-} g(x) = \pm\infty, \quad (2.4.2)$$

and suppose that

$$\lim_{x \rightarrow b^-} \frac{f'(x)}{g'(x)} = L \quad (\text{finite or } \pm\infty). \quad (2.4.3)$$

Then

$$\lim_{x \rightarrow b^-} \frac{f(x)}{g(x)} = L. \quad (2.4.4)$$

**Proof** We prove the theorem for finite  $L$  and leave the case where  $L = \pm\infty$  to you (Exercise 2.4.1).

Suppose that  $\epsilon > 0$ . From (2.4.3), there is an  $x_0$  in  $(a, b)$  such that

$$\left| \frac{f'(c)}{g'(c)} - L \right| < \epsilon \quad \text{if} \quad x_0 < c < b. \quad (2.4.5)$$

Theorem 2.3.10 implies that if  $x$  and  $t$  are in  $[x_0, b)$ , then there is a  $c$  between them, and therefore in  $(x_0, b)$ , such that

$$[g(x) - g(t)]f'(c) = [f(x) - f(t)]g'(c). \quad (2.4.6)$$

Since  $g'$  has no zeros in  $(a, b)$ , Theorem 2.3.11 implies that

$$g(x) - g(t) \neq 0 \quad \text{if} \quad x, t \in (a, b).$$

This means that  $g$  cannot have more than one zero in  $(a, b)$ . Therefore, we can choose  $x_0$  so that, in addition to (2.4.5),  $g$  has no zeros in  $[x_0, b)$ . Then (2.4.6) can be rewritten as

$$\frac{f(x) - f(t)}{g(x) - g(t)} = \frac{f'(c)}{g'(c)},$$

so (2.4.5) implies that

$$\left| \frac{f(x) - f(t)}{g(x) - g(t)} - L \right| < \epsilon \quad \text{if} \quad x, t \in [x_0, b). \quad (2.4.7)$$

If (2.4.1) holds, let  $x$  be fixed in  $[x_0, b)$ , and consider the function

$$G(t) = \frac{f(x) - f(t)}{g(x) - g(t)} - L.$$

From (2.4.1),

$$\lim_{t \rightarrow b^-} f(t) = \lim_{t \rightarrow b^-} g(t) = 0,$$

so

$$\lim_{t \rightarrow b^-} G(t) = \frac{f(x)}{g(x)} - L. \quad (2.4.8)$$

Since

$$|G(t)| < \epsilon \quad \text{if } x_0 < t < b,$$

because of (2.4.7), (2.4.8) implies that

$$\left| \frac{f(x)}{g(x)} - L \right| \leq \epsilon.$$

This holds for all  $x$  in  $(x_0, b)$ , which implies (2.4.4).

The proof under assumption (2.4.2) is more complicated. Again choose  $x_0$  so that (2.4.5) holds and  $g$  has no zeros in  $[x_0, b)$ . Letting  $t = x_0$  in (2.4.7), we see that

$$\left| \frac{f(x) - f(x_0)}{g(x) - g(x_0)} - L \right| < \epsilon \quad \text{if } x_0 \leq x < b. \quad (2.4.9)$$

Since  $\lim_{x \rightarrow b^-} f(x) = \pm\infty$ , we can choose  $x_1 > x_0$  so that  $f(x) \neq 0$  and  $f(x) \neq f(x_0)$  if  $x_1 < x < b$ . Then the function

$$u(x) = \frac{1 - g(x_0)/g(x)}{1 - f(x_0)/f(x)}$$

is defined and nonzero if  $x_1 < x < b$ , and

$$\lim_{x \rightarrow b^-} u(x) = 1, \quad (2.4.10)$$

because of (2.4.2).

Since

$$\frac{f(x) - f(x_0)}{g(x) - g(x_0)} = \frac{f(x)}{g(x)} \frac{1 - f(x_0)/f(x)}{1 - g(x_0)/g(x)} = \frac{f(x)}{g(x)u(x)},$$

(2.4.9) implies that

$$\left| \frac{f(x)}{g(x)u(x)} - L \right| < \epsilon \quad \text{if } x_1 < x < b,$$

which can be rewritten as

$$\left| \frac{f(x)}{g(x)} - Lu(x) \right| < \epsilon |u(x)| \quad \text{if } x_1 < x < b. \quad (2.4.11)$$

From this and the triangle inequality,

$$\left| \frac{f(x)}{g(x)} - L \right| \leq \left| \frac{f(x)}{g(x)} - Lu(x) \right| + |Lu(x) - L| \leq \epsilon |u(x)| + |L| |u(x) - 1|. \quad (2.4.12)$$

Because of (2.4.10), there is a point  $x_2$  in  $(x_1, b)$  such that

$$|u(x) - 1| < \epsilon \quad \text{and therefore} \quad |u(x)| < 1 + \epsilon \quad \text{if } x_2 < x < b.$$

This, (2.4.11), and (2.4.12) imply that

$$\left| \frac{f(x)}{g(x)} - L \right| < \epsilon(1 + \epsilon) + |L|\epsilon \quad \text{if } x_2 < x < b,$$

which proves (2.4.4) under assumption (2.4.2). ■

Theorem 2.4.1 and the proof given here remain valid if  $b = \infty$  and “ $x \rightarrow b-$ ” is replaced by “ $x \rightarrow \infty$ ” throughout. Only minor changes in the proof are required to show that similar theorems are valid for limits from the right, limits at  $-\infty$ , and ordinary (two-sided) limits. We will take these as given.

### The Indeterminate Forms $0/0$ and $\infty/\infty$

We say that  $f/g$  is of the form  $0/0$  as  $x \rightarrow b-$  if

$$\lim_{x \rightarrow b-} f(x) = \lim_{x \rightarrow b-} g(x) = 0,$$

or of the form  $\infty/\infty$  as  $x \rightarrow b-$  if

$$\lim_{x \rightarrow b-} f(x) = \pm\infty$$

and

$$\lim_{x \rightarrow b-} g(x) = \pm\infty.$$

The corresponding definitions for  $x \rightarrow b+$  and  $x \rightarrow \pm\infty$  are similar. If  $f/g$  is of one of these forms as  $x \rightarrow b-$  and as  $x \rightarrow b+$ , then we say that it is of that form as  $x \rightarrow b$ .

**Example 2.4.1** The ratio  $\sin x/x$  is of the form  $0/0$  as  $x \rightarrow 0$ , and L'Hospital's rule yields

$$\lim_{x \rightarrow 0} \frac{\sin x}{x} = \lim_{x \rightarrow 0} \frac{\cos x}{1} = 1.$$

**Example 2.4.2** The ratio  $e^{-x}/x$  is of the form  $\infty/\infty$  as  $x \rightarrow -\infty$ , and L'Hospital's rule yields

$$\lim_{x \rightarrow -\infty} \frac{e^{-x}}{x} = \lim_{x \rightarrow -\infty} \frac{-e^{-x}}{1} = -\infty.$$

**Example 2.4.3** Using L'Hospital's rule may lead to another indeterminate form; thus,

$$\lim_{x \rightarrow \infty} \frac{e^x}{x^2} = \lim_{x \rightarrow \infty} \frac{e^x}{2x}$$

if the limit on the right exists in the extended reals. Applying L'Hospital's rule again yields

$$\lim_{x \rightarrow \infty} \frac{e^x}{2x} = \lim_{x \rightarrow \infty} \frac{e^x}{2} = \infty.$$

Therefore,

$$\lim_{x \rightarrow \infty} \frac{e^x}{x^2} = \infty.$$

More generally,

$$\lim_{x \rightarrow \infty} \frac{e^x}{x^\alpha} = \infty$$

for any real number  $\alpha$  (Exercise 2.4.33).

**Example 2.4.4** Sometimes it pays to combine L'Hospital's rule with other manipulations. For example,

$$\begin{aligned} \lim_{x \rightarrow 0} \frac{4 - 4 \cos x - 2 \sin^2 x}{x^4} &= \lim_{x \rightarrow 0} \frac{4 \sin x - 4 \sin x \cos x}{4x^3} \\ &= \left( \lim_{x \rightarrow 0} \frac{\sin x}{x} \right) \left( \lim_{x \rightarrow 0} \frac{1 - \cos x}{x^2} \right) \\ &= \left( \lim_{x \rightarrow 0} \frac{\sin x}{x} \right) \left( \lim_{x \rightarrow 0} \frac{\sin x}{2x} \right) \\ &= \frac{1}{2} \left( \lim_{x \rightarrow 0} \frac{\sin x}{x} \right)^2 \\ &= \frac{1}{2} (1)^2 = \frac{1}{2} \quad (\text{Example 2.4.1}). \end{aligned}$$

As another example, L'Hospital's rule yields

$$\lim_{x \rightarrow 0} \frac{e^{-x^2} \log(1+x)}{x} = \lim_{x \rightarrow 0} \frac{-2xe^{-x^2} \log(1+x) + e^{-x^2} (1+x)^{-1}}{1} = 1.$$

However, it is better to remove the “determinate” part of the ratio before using L'Hospital's rule:

$$\begin{aligned} \lim_{x \rightarrow 0} \frac{e^{-x^2} \log(1+x)}{x} &= \left( \lim_{x \rightarrow 0} e^{-x^2} \right) \left( \lim_{x \rightarrow 0} \frac{\log(1+x)}{x} \right) \\ &= (1) \lim_{x \rightarrow 0} \frac{\log(1+x)}{x} \\ &= \lim_{x \rightarrow 0} \frac{1/(1+x)}{1} = 1. \quad \blacksquare \end{aligned}$$

In using L'Hospital's rule we usually write, for example,

$$\lim_{x \rightarrow b} \frac{f(x)}{g(x)} = \lim_{x \rightarrow b} \frac{f'(x)}{g'(x)} \quad (2.4.13)$$

and then try to find the limit on the right. This is convenient, but technically incorrect, since (2.4.13) is true only if the limit on the right exists in the extended reals. It may happen that the limit on the left exists but the one on the right does not. In this case, (2.4.13) is incorrect.

**Example 2.4.5** If

$$f(x) = x - x^2 \sin \frac{1}{x} \quad \text{and} \quad g(x) = \sin x,$$

then

$$f'(x) = 1 - 2x \sin \frac{1}{x} + \cos \frac{1}{x} \quad \text{and} \quad g'(x) = \cos x.$$

Therefore,  $\lim_{x \rightarrow 0} f'(x)/g'(x)$  does not exist. However,

$$\lim_{x \rightarrow 0} \frac{f(x)}{g(x)} = \lim_{x \rightarrow 0} \frac{1 - x \sin(1/x)}{(\sin x)/x} = \frac{1}{1} = 1.$$

### The Indeterminate Form $0 \cdot \infty$

We say that a product  $fg$  is of the form  $0 \cdot \infty$  as  $x \rightarrow b$ — if one of the factors approaches 0 and the other approaches  $\pm\infty$  as  $x \rightarrow b$ —. In this case, it may be useful to apply L'Hospital's rule after writing

$$f(x)g(x) = \frac{f(x)}{1/g(x)} \quad \text{or} \quad f(x)g(x) = \frac{g(x)}{1/f(x)},$$

since one of these ratios is of the form  $0/0$  and the other is of the form  $\infty/\infty$  as  $x \rightarrow b$ —.

Similar statements apply to limits as  $x \rightarrow b+$ ,  $x \rightarrow b$ , and  $x \rightarrow \pm\infty$ .

**Example 2.4.6** The product  $x \log x$  is of the form  $0 \cdot \infty$  as  $x \rightarrow 0+$ . Converting it to an  $\infty/\infty$  form yields

$$\begin{aligned} \lim_{x \rightarrow 0+} x \log x &= \lim_{x \rightarrow 0+} \frac{\log x}{1/x} \\ &= \lim_{x \rightarrow 0+} \frac{1/x}{-1/x^2} \\ &= - \lim_{x \rightarrow 0+} x = 0. \end{aligned}$$

Converting to a  $0/0$  form leads to a more complicated problem:

$$\begin{aligned} \lim_{x \rightarrow 0+} x \log x &= \lim_{x \rightarrow 0+} \frac{x}{1/\log x} \\ &= \lim_{x \rightarrow 0+} \frac{1}{-1/x(\log x)^2} \\ &= - \lim_{x \rightarrow 0+} x(\log x)^2 = ? \end{aligned}$$

**Example 2.4.7** The product  $x \log(1 + 1/x)$  is of the form  $0 \cdot \infty$  as  $x \rightarrow \infty$ . Converting it to a  $0/0$  form yields

$$\begin{aligned} \lim_{x \rightarrow \infty} x \log(1 + 1/x) &= \lim_{x \rightarrow \infty} \frac{\log(1 + 1/x)}{1/x} \\ &= \lim_{x \rightarrow \infty} \frac{[1/(1 + 1/x)](-1/x^2)}{-1/x^2} \\ &= \lim_{x \rightarrow \infty} \frac{1}{1 + 1/x} = 1. \end{aligned}$$

In this case, converting to an  $\infty/\infty$  form complicates the problem:

$$\begin{aligned}\lim_{x \rightarrow \infty} x \log(1 + 1/x) &= \lim_{x \rightarrow \infty} \frac{x}{1/\log(1 + 1/x)} \\ &= \lim_{x \rightarrow \infty} \frac{1}{\left(\frac{-1}{[\log(1 + 1/x)]^2}\right) \left(\frac{-1/x^2}{1 + 1/x}\right)} \\ &= \lim_{x \rightarrow \infty} x(x + 1)[\log(1 + 1/x)]^2 = ?\end{aligned}$$

### The Indeterminate Form $\infty - \infty$

A difference  $f - g$  is of the form  $\infty - \infty$  as  $x \rightarrow b-$  if

$$\lim_{x \rightarrow b-} f(x) = \lim_{x \rightarrow b-} g(x) = \pm\infty.$$

In this case, it may be possible to manipulate  $f - g$  into an expression that is no longer indeterminate, or is of the form  $0/0$  or  $\infty/\infty$  as  $x \rightarrow b-$ . Similar remarks apply to limits as  $x \rightarrow b+$ ,  $x \rightarrow b$ , or  $x \rightarrow \pm\infty$ .

**Example 2.4.8** The difference

$$\frac{\sin x}{x^2} - \frac{1}{x}$$

is of the form  $\infty - \infty$  as  $x \rightarrow 0$ , but it can be rewritten as the  $0/0$  form

$$\frac{\sin x - x}{x^2}.$$

Hence,

$$\begin{aligned}\lim_{x \rightarrow 0} \left( \frac{\sin x}{x^2} - \frac{1}{x} \right) &= \lim_{x \rightarrow 0} \frac{\sin x - x}{x^2} = \lim_{x \rightarrow 0} \frac{\cos x - 1}{2x} \\ &= \lim_{x \rightarrow 0} \frac{-\sin x}{2} = 0.\end{aligned}$$

**Example 2.4.9** The difference

$$x^2 - x$$

is of the form  $\infty - \infty$  as  $x \rightarrow \infty$ . Rewriting it as

$$x^2 \left( 1 - \frac{1}{x} \right),$$

which is no longer indeterminate as  $x \rightarrow \infty$ , we find that

$$\begin{aligned}\lim_{x \rightarrow \infty} (x^2 - x) &= \lim_{x \rightarrow \infty} x^2 \left( 1 - \frac{1}{x} \right) \\ &= \left( \lim_{x \rightarrow \infty} x^2 \right) \lim_{x \rightarrow \infty} \left( 1 - \frac{1}{x} \right) \\ &= (\infty)(1) = \infty\end{aligned}$$

**The Indeterminate Forms  $0^0$ ,  $1^\infty$ , and  $\infty^0$** 

The function  $f^g$  is defined by

$$f(x)^{g(x)} = e^{g(x) \log f(x)} = \exp(g(x) \log f(x))$$

for all  $x$  such that  $f(x) > 0$ . Therefore, if  $f$  and  $g$  are defined and  $f(x) > 0$  on an interval  $(a, b)$ , Exercise 2.2.22 implies that

$$\lim_{x \rightarrow b^-} [f(x)]^{g(x)} = \exp\left(\lim_{x \rightarrow b^-} g(x) \log f(x)\right) \quad (2.4.14)$$

if  $\lim_{x \rightarrow b^-} g(x) \log f(x)$  exists in the extended reals. (If this limit is  $\pm\infty$  then (2.4.14) is valid if we define  $e^{-\infty} = 0$  and  $e^\infty = \infty$ .) The product  $g \log f$  can be of the form  $0 \cdot \infty$  in three ways as  $x \rightarrow b^-$ :

- (a) If  $\lim_{x \rightarrow b^-} g(x) = 0$  and  $\lim_{x \rightarrow b^-} f(x) = 0$ .
- (b) If  $\lim_{x \rightarrow b^-} g(x) = \pm\infty$  and  $\lim_{x \rightarrow b^-} f(x) = 1$ .
- (c) If  $\lim_{x \rightarrow b^-} g(x) = 0$  and  $\lim_{x \rightarrow b^-} f(x) = \infty$ .

In these three cases, we say that  $f^g$  is of the form  $0^0$ ,  $1^\infty$ , and  $\infty^0$ , respectively, as  $x \rightarrow b^-$ . Similar definitions apply to limits as  $x \rightarrow b^+$ ,  $x \rightarrow b$ , and  $x \rightarrow \pm\infty$ .

**Example 2.4.10** The function  $x^x$  is of the form  $0^0$  as  $x \rightarrow 0^+$ . Since

$$x^x = e^{x \log x}$$

and  $\lim_{x \rightarrow 0^+} x \log x = 0$  (Example 2.4.6),

$$\lim_{x \rightarrow 0^+} x^x = e^0 = 1.$$

**Example 2.4.11** The function  $x^{1/(x-1)}$  is of the form  $1^\infty$  as  $x \rightarrow 1$ . Since

$$x^{1/(x-1)} = \exp\left(\frac{\log x}{x-1}\right)$$

and

$$\lim_{x \rightarrow 1} \frac{\log x}{x-1} = \lim_{x \rightarrow 1} \frac{1/x}{1} = 1,$$

it follows that

$$\lim_{x \rightarrow 1} x^{1/(x-1)} = e^1 = e.$$

**Example 2.4.12** The function  $x^{1/x}$  is of the form  $\infty^0$  as  $x \rightarrow \infty$ . Since

$$x^{1/x} = \exp\left(\frac{\log x}{x}\right)$$

and

$$\lim_{x \rightarrow \infty} \frac{\log x}{x} = \lim_{x \rightarrow \infty} \frac{1/x}{1} = 0,$$

it follows that

$$\lim_{x \rightarrow \infty} x^{1/x} = e^0 = 1.$$

## 2.4 Exercises

1. Prove Theorem 2.4.1 for the case where  $\lim_{x \rightarrow b^-} f'(x)/g'(x) = \pm\infty$ .

In Exercises 2.4.2–2.4.40, find the indicated limits.

2.  $\lim_{x \rightarrow 0} \frac{\tan^{-1} x}{\sin^{-1} x}$       3.  $\lim_{x \rightarrow 0} \frac{1 - \cos x}{\log(1 + x^2)}$       4.  $\lim_{x \rightarrow 0^+} \frac{1 + \cos x}{e^x - 1}$
5.  $\lim_{x \rightarrow \pi} \frac{\sin nx}{\sin x}$       6.  $\lim_{x \rightarrow 0} \frac{\log(1 + x)}{x}$       7.  $\lim_{x \rightarrow \infty} e^x \sin e^{-x^2}$
8.  $\lim_{x \rightarrow \infty} x \sin(1/x)$       9.  $\lim_{x \rightarrow \infty} \sqrt{x}(e^{-1/x} - 1)$       10.  $\lim_{x \rightarrow 0^+} \tan x \log x$
11.  $\lim_{x \rightarrow \pi} \sin x \log(|\tan x|)$       12.  $\lim_{x \rightarrow 0^+} \left[ \frac{1}{x} + \log(\tan x) \right]$
13.  $\lim_{x \rightarrow \infty} (\sqrt{x+1} - \sqrt{x})$       14.  $\lim_{x \rightarrow 0} \left( \frac{1}{e^x - 1} - \frac{1}{x} \right)$
15.  $\lim_{x \rightarrow 0} (\cot x - \csc x)$       16.  $\lim_{x \rightarrow 0} \left( \frac{1}{\sin x} - \frac{1}{x} \right)$
17.  $\lim_{x \rightarrow \pi} |\sin x|^{\tan x}$       18.  $\lim_{x \rightarrow \pi/2} |\tan x|^{\cos x}$
19.  $\lim_{x \rightarrow 0} |\sin x|^x$       20.  $\lim_{x \rightarrow 0} (1 + x)^{1/x}$
21.  $\lim_{x \rightarrow \infty} x^{\sin(1/x)}$       22.  $\lim_{x \rightarrow 0} \left( \frac{x}{1 - \cos x} - \frac{2}{x} \right)$
23.  $\lim_{x \rightarrow 0^+} x^\alpha \log x$       24.  $\lim_{x \rightarrow e} \frac{\log(\log x)}{\sin(x - e)}$
25.  $\lim_{x \rightarrow \infty} \left( \frac{x+1}{x-1} \right)^{\sqrt{x^2-1}}$       26.  $\lim_{x \rightarrow 1^+} \left( \frac{x+1}{x-1} \right)^{\sqrt{x^2-1}}$
27.  $\lim_{x \rightarrow \infty} \frac{(\log x)^\beta}{x}$       28.  $\lim_{x \rightarrow \infty} (\cosh x - \sinh x)$
29.  $\lim_{x \rightarrow \infty} (x^\alpha - \log x)$       30.  $\lim_{x \rightarrow -\infty} e^{x^2} \sin(e^x)$



$$31. \lim_{x \rightarrow \infty} x(x+1) [\log(1+1/x)]^2 \quad 32. \lim_{x \rightarrow 0} \frac{\sin x - x + x^3/6}{x^5}$$

$$33. \lim_{x \rightarrow \infty} \frac{e^x}{x^\alpha} \quad 34. \lim_{x \rightarrow 3\pi/2^-} e^{\tan x} \cos x$$

$$35. \lim_{x \rightarrow 1^+} (\log x)^\alpha \log(\log x) \quad 36. \lim_{x \rightarrow \infty} \frac{x^x}{x \log x}$$

$$37. \lim_{x \rightarrow \pi/2} (\sin x)^{\tan x}$$

$$38. \lim_{x \rightarrow 0} \frac{e^x - \sum_{r=0}^n x^r r!}{x^n} \quad (n = \text{integer} \geq 1)$$

$$39. \lim_{x \rightarrow 0} \frac{\sin x - \sum_{r=0}^n (-1)^r \frac{x^{2r+1}}{(2r+1)!}}{x^{2n+1}} \quad (n = \text{integer} \geq 0)$$

$$40. \lim_{x \rightarrow 0} \frac{e^{-1/x^2}}{x^n} = 0 \quad (n = \text{integer})$$

41. (a) Prove: If  $f$  is continuous at  $x_0$  and  $\lim_{x \rightarrow x_0} f'(x)$  exists, then  $f'(x_0)$  exists and  $f'$  is continuous at  $x_0$ .

(b) Give an example to show that it is necessary to assume in (a) that  $f$  is continuous at  $x_0$ .

42. The iterated logarithms are defined by  $L_0(x) = x$  and

$$L_n(x) = \log(L_{n-1}(x)), \quad x > a_n, \quad n \geq 1,$$

where  $a_1 = 0$  and  $a_n = e^{a_{n-1}}, n \geq 1$ . Show that

$$(a) \quad L_n(x) = L_{n-1}(\log x), \quad x > a_n, \quad n \geq 1.$$

$$(b) \quad L_{n-1}(a_n+) = 0 \text{ and } L_n(a_n+) = -\infty.$$

$$(c) \quad \lim_{x \rightarrow a_n+} (L_{n-1}(x))^\alpha L_n(x) = 0 \text{ if } \alpha > 0 \text{ and } n \geq 1.$$

$$(d) \quad \lim_{x \rightarrow \infty} (L_n(x))^\alpha / L_{n-1}(x) = 0 \text{ if } \alpha \text{ is arbitrary and } n \geq 1.$$

43. Let  $f$  be positive and differentiable on  $(0, \infty)$ , and suppose that

$$\lim_{x \rightarrow \infty} \frac{f'(x)}{f(x)} = L, \quad \text{where } 0 < L \leq \infty.$$

Define  $f_0(x) = x$  and

$$f_n(x) = f(f_{n-1}(x)), \quad n \geq 1.$$

Use L'Hospital's rule to show that

$$\lim_{x \rightarrow \infty} \frac{(f_n(x))^\alpha}{f_{n-1}(x)} = \infty \quad \text{if } \alpha > 0 \text{ and } n \geq 1.$$

44. Let  $f$  be differentiable on some deleted neighborhood  $N$  of  $x_0$ , and suppose that  $f$  and  $f'$  have no zeros in  $N$ . Find

(a)  $\lim_{x \rightarrow x_0} |f(x)|^{f(x)}$  if  $\lim_{x \rightarrow x_0} f(x) = 0$ ;

(b)  $\lim_{x \rightarrow x_0} |f(x)|^{1/(f(x)-1)}$  if  $\lim_{x \rightarrow x_0} f(x) = 1$ ;

(c)  $\lim_{x \rightarrow x_0} |f(x)|^{1/f(x)}$  if  $\lim_{x \rightarrow x_0} f(x) = \infty$ .

45. Suppose that  $f$  and  $g$  are differentiable and  $g'$  has no zeros on  $(a, b)$ . Suppose also that  $\lim_{x \rightarrow b^-} f'(x)/g'(x) = L$  and either

$$\lim_{x \rightarrow b^-} f(x) = \lim_{x \rightarrow b^-} g(x) = 0$$

or

$$\lim_{x \rightarrow b^-} f(x) = \infty \quad \text{and} \quad \lim_{x \rightarrow b^-} g(x) = \pm\infty.$$

Find  $\lim_{x \rightarrow b^-} (1 + f(x))^{1/g(x)}$ .

46. We distinguish between  $\infty \cdot \infty (= \infty)$  and  $(-\infty)\infty (= -\infty)$  and between  $\infty + \infty (= \infty)$  and  $-\infty - \infty (= -\infty)$ . Why don't we distinguish between  $0 \cdot \infty$  and  $0 \cdot (-\infty)$ ,  $\infty - \infty$  and  $-\infty + \infty$ ,  $\infty/\infty$  and  $-\infty/\infty$ , and  $1^\infty$  and  $1^{-\infty}$ ?

## 2.5 TAYLOR'S THEOREM

A *polynomial* is a function of the form

$$p(x) = a_0 + a_1(x - x_0) + \cdots + a_n(x - x_0)^n, \quad (2.5.1)$$

where  $a_0, \dots, a_n$  and  $x_0$  are constants. Since it is easy to calculate the values of a polynomial, considerable effort has been devoted to using them to approximate more complicated functions. Taylor's theorem is one of the oldest and most important results on this question.

The polynomial (2.5.1) is said to be written *in powers of*  $x - x_0$ , and is *of degree*  $n$  if  $a_n \neq 0$ . If we wish to leave open the possibility that  $a_n = 0$ , we say that  $p$  is of degree  $\leq n$ . In particular, a constant polynomial  $p(x) = a_0$  is of degree zero if  $a_0 \neq 0$ . If  $a_0 = 0$ , so that  $p$  vanishes identically, then  $p$  has no degree according to our definition, which requires at least one coefficient to be nonzero. For convenience we say that the identically zero polynomial  $p$  has degree  $-\infty$ . (Any negative number would do as well as  $-\infty$ . The point is that with this convention, the statement that  $p$  is a polynomial of degree  $\leq n$  includes the possibility that  $p$  is identically zero.)

### Taylor Polynomials

We saw in Lemma 2.3.2 that if  $f$  is differentiable at  $x_0$ , then

$$f(x) = f(x_0) + f'(x_0)(x - x_0) + E(x)(x - x_0),$$

where

$$\lim_{x \rightarrow x_0} E(x) = 0.$$

To generalize this result, we first restate it: the polynomial

$$T_1(x) = f(x_0) + f'(x_0)(x - x_0),$$

which is of degree  $\leq 1$  and satisfies

$$T_1(x_0) = f(x_0), \quad T_1'(x_0) = f'(x_0),$$

approximates  $f$  so well near  $x_0$  that

$$\lim_{x \rightarrow x_0} \frac{f(x) - T_1(x)}{x - x_0} = 0. \quad (2.5.2)$$

Now suppose that  $f$  has  $n$  derivatives at  $x_0$  and  $T_n$  is the polynomial of degree  $\leq n$  such that

$$T_n^{(r)}(x_0) = f^{(r)}(x_0), \quad 0 \leq r \leq n. \quad (2.5.3)$$

How well does  $T_n$  approximate  $f$  near  $x_0$ ?

To answer this question, we must first find  $T_n$ . Since  $T_n$  is a polynomial of degree  $\leq n$ , it can be written as

$$T_n(x) = a_0 + a_1(x - x_0) + \cdots + a_n(x - x_0)^n, \quad (2.5.4)$$

where  $a_0, \dots, a_n$  are constants. Differentiating (2.5.4) yields

$$T_n^{(r)}(x_0) = r!a_r, \quad 0 \leq r \leq n,$$

so (2.5.3) determines  $a_r$  uniquely as

$$a_r = \frac{f^{(r)}(x_0)}{r!}, \quad 0 \leq r \leq n.$$

Therefore,

$$\begin{aligned} T_n(x) &= f(x_0) + \frac{f'(x_0)}{1!}(x - x_0) + \cdots + \frac{f^{(n)}(x_0)}{n!}(x - x_0)^n \\ &= \sum_{r=0}^n \frac{f^{(r)}(x_0)}{r!}(x - x_0)^r. \end{aligned}$$

We call  $T_n$  the *nth Taylor polynomial of  $f$  about  $x_0$* .

The following theorem describes how  $T_n$  approximates  $f$  near  $x_0$ .

**Theorem 2.5.1** *If  $f^{(n)}(x_0)$  exists for some integer  $n \geq 1$  and  $T_n$  is the  $n$ th Taylor polynomial of  $f$  about  $x_0$ , then*

$$\lim_{x \rightarrow x_0} \frac{f(x) - T_n(x)}{(x - x_0)^n} = 0. \quad (2.5.5)$$

**Proof** The proof is by induction. Let  $P_n$  be the assertion of the theorem. From (2.5.2) we know that (2.5.5) is true if  $n = 1$ ; that is,  $P_1$  is true. Now suppose that  $P_n$  is true for some integer  $n \geq 1$ , and  $f^{(n+1)}$  exists. Since the ratio

$$\frac{f(x) - T_{n+1}(x)}{(x - x_0)^{n+1}}$$

is indeterminate of the form  $0/0$  as  $x \rightarrow x_0$ , L'Hospital's rule implies that

$$\lim_{x \rightarrow x_0} \frac{f(x) - T_{n+1}(x)}{(x - x_0)^{n+1}} = \frac{1}{n+1} \lim_{x \rightarrow x_0} \frac{f'(x) - T'_{n+1}(x)}{(x - x_0)^n} \quad (2.5.6)$$

if the limit on the right exists. But  $f'$  has an  $n$ th derivative at  $x_0$ , and

$$T'_{n+1}(x) = \sum_{r=0}^n \frac{f^{(r+1)}(x_0)}{r!} (x - x_0)^r$$

is the  $n$ th Taylor polynomial of  $f'$  about  $x_0$ . Therefore, the induction assumption, applied to  $f'$ , implies that

$$\lim_{x \rightarrow x_0} \frac{f'(x) - T'_{n+1}(x)}{(x - x_0)^n} = 0.$$

This and (2.5.6) imply that

$$\lim_{x \rightarrow x_0} \frac{f(x) - T_{n+1}(x)}{(x - x_0)^{n+1}} = 0,$$

which completes the induction. ■

It can be shown (Exercise 2.5.8) that if

$$p_n = a_0 + a_1(x - x_0) + \cdots + a_n(x - x_0)^n$$

is a polynomial of degree  $\leq n$  such that

$$\lim_{x \rightarrow x_0} \frac{f(x) - p_n(x)}{(x - x_0)^n} = 0,$$

then

$$a_r = \frac{f^{(r)}(x_0)}{r!};$$

that is,  $p_n = T_n$ . Thus,  $T_n$  is the only polynomial of degree  $\leq n$  that approximates  $f$  near  $x_0$  in the manner indicated in (2.5.5).

Theorem 2.5.1 can be restated as a generalization of Lemma 2.3.2.

**Lemma 2.5.2** *If  $f^{(n)}(x_0)$  exists, then*

$$f(x) = \sum_{r=0}^n \frac{f^{(r)}(x_0)}{r!} (x - x_0)^r + E_n(x)(x - x_0)^n, \quad (2.5.7)$$

where

$$\lim_{x \rightarrow x_0} E_n(x) = E_n(x_0) = 0.$$

**Proof** Define

$$E_n(x) = \begin{cases} \frac{f(x) - T_n(x)}{(x - x_0)^n}, & x \in D_f - \{x_0\}, \\ 0, & x = x_0. \end{cases}$$

Then (2.5.5) implies that  $\lim_{x \rightarrow x_0} E_n(x) = E_n(x_0) = 0$ , and it is straightforward to verify (2.5.7). ■

**Example 2.5.1** If  $f(x) = e^x$ , then  $f^{(n)}(x) = e^x$ . Therefore,  $f^{(n)}(0) = 1$  for  $n \geq 0$ , so the  $n$ th Taylor polynomial of  $f$  about  $x_0 = 0$  is

$$T_n(x) = \sum_{r=0}^n \frac{x^r}{r!} = 1 + \frac{x}{1!} + \frac{x^2}{2!} + \cdots + \frac{x^n}{n!}. \quad (2.5.8)$$

Theorem 2.5.1 implies that

$$\lim_{x \rightarrow 0} \frac{e^x - \sum_{r=0}^n \frac{x^r}{r!}}{x^n} = 0.$$

(See also Exercise 2.4.38.)

**Example 2.5.2** If  $f(x) = \log x$ , then  $f(1) = 0$  and

$$f^{(r)}(x) = (-1)^{(r-1)} \frac{(r-1)!}{x^r}, \quad r \geq 1,$$

so the  $n$ th Taylor polynomial of  $f$  about  $x_0 = 1$  is

$$T_n(x) = \sum_{r=1}^n \frac{(-1)^{r-1}}{r} (x-1)^r$$

if  $n \geq 1$ . ( $T_0 = 0$ .) Theorem 2.5.1 implies that

$$\lim_{x \rightarrow 1} \frac{\log x - \sum_{r=1}^n (-1)^{r-1} \frac{(x-1)^r}{r}}{(x-1)^n} = 0, \quad n \geq 1.$$

**Example 2.5.3** If  $f(x) = (1+x)^q$ , then

$$\begin{aligned} f'(x) &= q(1+x)^{q-1} \\ f''(x) &= q(q-1)(1+x)^{q-2} \\ &\vdots \\ f^{(n)}(x) &= q(q-1) \cdots (q-n+1)(1+x)^{q-n}. \end{aligned}$$

If we define

$$\binom{q}{0} = 1 \quad \text{and} \quad \binom{q}{n} = \frac{q(q-1)\cdots(q-n+1)}{n!}, \quad n \geq 1,$$

then

$$\frac{f^{(n)}(0)}{n!} = \binom{q}{n},$$

and the  $n$ th Taylor polynomial of  $f$  about 0 can be written as

$$T_n(x) = \sum_{r=0}^n \binom{q}{r} x^r. \quad (2.5.9)$$

Theorem 2.5.1 implies that

$$\lim_{x \rightarrow 0} \frac{(1+x)^q - \sum_{r=0}^n \binom{q}{r} x^r}{x^n} = 0, \quad n \geq 0. \quad \blacksquare$$

If  $q$  is a nonnegative integer, then  $\binom{q}{n}$  is the binomial coefficient defined in Exercise 1.2.19. In this case, we see from (2.5.9) that

$$T_n(x) = (1+x)^q = f(x), \quad n \geq q.$$

## Applications to Finding Local Extrema

Lemma 2.5.2 yields the following theorem.

**Theorem 2.5.3** *Suppose that  $f$  has  $n$  derivatives at  $x_0$  and  $n$  is the smallest positive integer such that  $f^{(n)}(x_0) \neq 0$ .*

- (a) *If  $n$  is odd,  $x_0$  is not a local extreme point of  $f$ .*
- (b) *If  $n$  is even,  $x_0$  is a local maximum of  $f$  if  $f^{(n)}(x_0) < 0$ , or a local minimum of  $f$  if  $f^{(n)}(x_0) > 0$ .*

**Proof** Since  $f^{(r)}(x_0) = 0$  for  $1 \leq r \leq n-1$ , (2.5.7) implies that

$$f(x) - f(x_0) = \left[ \frac{f^{(n)}(x_0)}{n!} + E_n(x) \right] (x - x_0)^n \quad (2.5.10)$$

in some interval containing  $x_0$ . Since  $\lim_{x \rightarrow x_0} E_n(x) = 0$  and  $f^{(n)}(x_0) \neq 0$ , there is a  $\delta > 0$  such that

$$|E_n(x)| < \left| \frac{f^{(n)}(x_0)}{n!} \right| \quad \text{if} \quad |x - x_0| < \delta.$$

This and (2.5.10) imply that

$$\frac{f(x) - f(x_0)}{(x - x_0)^n} \quad (2.5.11)$$

has the same sign as  $f^{(n)}(x_0)$  if  $0 < |x - x_0| < \delta$ . If  $n$  is odd the denominator of (2.5.11) changes sign in every neighborhood of  $x_0$ , and therefore so must the numerator (since the ratio has constant sign for  $0 < |x - x_0| < \delta$ ). Consequently,  $f(x_0)$  cannot be a local extreme value of  $f$ . This proves (a). If  $n$  is even, the denominator of (2.5.11) is positive for  $x \neq x_0$ , so  $f(x) - f(x_0)$  must have the same sign as  $f^{(n)}(x_0)$  for  $0 < |x - x_0| < \delta$ . This proves (b). ■

For  $n = 2$ , (b) is called the *second derivative test* for local extreme points.

**Example 2.5.4** If  $f(x) = e^{x^3}$ , then  $f'(x) = 3x^2e^{x^3}$ , and 0 is the only critical point of  $f$ . Since

$$f''(x) = (6x + 9x^4)e^{x^3}$$

and

$$f'''(x) = (6 + 54x^3 + 27x^6)e^{x^3},$$

$f''(0) = 0$  and  $f'''(0) \neq 0$ . Therefore, Theorem 2.5.3 implies that 0 is not a local extreme point of  $f$ . Since  $f$  is differentiable everywhere, it has no local maxima or minima.

**Example 2.5.5** If  $f(x) = \sin x^2$ , then  $f'(x) = 2x \cos x^2$ , so the critical points of  $f$  are 0 and  $\pm \sqrt{(k + 1/2)\pi}$ ,  $k = 0, 1, 2, \dots$ . Since

$$f''(x) = 2 \cos x^2 - 4x^2 \sin x^2,$$

$$f''(0) = 2 \quad \text{and} \quad f''\left(\pm \sqrt{(k + 1/2)\pi}\right) = (-1)^{k+1}(4k + 2)\pi.$$

Therefore, Theorem 2.5.3 implies that  $f$  attains local minima at 0 and  $\pm \sqrt{(k + 1/2)\pi}$  for odd integers  $k$ , and local maxima at  $\pm \sqrt{(k + 1/2)\pi}$  for even integers  $k$ .

## Taylor's theorem

Theorem 2.5.1 implies that the error in approximating  $f(x)$  by  $T_n(x)$  approaches zero faster than  $(x - x_0)^n$  as  $x$  approaches  $x_0$ ; however, it gives no estimate of the error in approximating  $f(x)$  by  $T_n(x)$  for a fixed  $x$ . For instance, it provides no estimate of the error in the approximation

$$e^{0.1} \approx T_2(0.1) = 1 + \frac{0.1}{1!} + \frac{(0.1)^2}{2!} = 1.105 \quad (2.5.12)$$

obtained by setting  $n = 2$  and  $x = 0.1$  in (2.5.8). The following theorem provides a way of estimating errors of this kind under the additional assumption that  $f^{(n+1)}$  exists in a neighborhood of  $x_0$ .

**Theorem 2.5.4 (Taylor's Theorem)** Suppose that  $f^{(n+1)}$  exists on an open interval  $I$  about  $x_0$ , and let  $x$  be in  $I$ . Then the remainder

$$R_n(x) = f(x) - T_n(x)$$

can be written as

$$R_n(x) = \frac{f^{(n+1)}(c)}{(n+1)!} (x - x_0)^{n+1},$$

where  $c$  depends upon  $x$  and is between  $x$  and  $x_0$ .

This theorem follows from an extension of the mean value theorem that we will prove below. For now, let us assume that Theorem 2.5.4 is correct, and apply it.

**Example 2.5.6** If  $f(x) = e^x$ , then  $f'''(x) = e^x$ , and Theorem 2.5.4 with  $n = 2$  implies that

$$e^x = 1 + x + \frac{x^2}{2!} + \frac{e^c x^3}{3!},$$

where  $c$  is between 0 and  $x$ . Hence, from (2.5.12),

$$e^{0.1} = 1.105 + \frac{e^c (0.1)^3}{6},$$

where  $0 < c < 0.1$ . Since  $0 < e^c < e^{0.1}$ , we know from this that

$$1.105 < e^{0.1} < 1.105 + \frac{e^{0.1} (0.1)^3}{6}.$$

The second inequality implies that

$$e^{0.1} \left[ 1 - \frac{(0.1)^3}{6} \right] < 1.105,$$

so

$$e^{0.1} < 1.1052.$$

Therefore,

$$1.105 < e^{0.1} < 1.1052,$$

and the error in (2.5.12) is less than 0.0002.

**Example 2.5.7** In numerical analysis, *forward differences* are used to approximate derivatives. If  $h > 0$ , the *first and second forward differences with spacing  $h$*  are defined by

$$\Delta f(x) = f(x+h) - f(x)$$

and

$$\begin{aligned} \Delta^2 f(x) &= \Delta[\Delta f(x)] = \Delta f(x+h) - \Delta f(x) \\ &= f(x+2h) - 2f(x+h) + f(x). \end{aligned} \tag{2.5.13}$$

Higher forward differences are defined inductively (Exercise 2.5.18).



We will find upper bounds for the magnitudes of the errors in the approximations

$$f'(x_0) \approx \frac{\Delta f(x_0)}{h} \quad (2.5.14)$$

and

$$f''(x_0) \approx \frac{\Delta^2 f(x_0)}{h^2}. \quad (2.5.15)$$

If  $f''$  exists on an open interval containing  $x_0$  and  $x_0 + h$ , we can use Theorem 2.5.4 to estimate the error in (2.5.14) by writing

$$f(x_0 + h) = f(x_0) + f'(x_0)h + \frac{f''(c)h^2}{2}, \quad (2.5.16)$$

where  $x_0 < c < x_0 + h$ . We can rewrite (2.5.16) as

$$\frac{f(x_0 + h) - f(x_0)}{h} - f'(x_0) = \frac{f''(c)h}{2},$$

which is equivalent to

$$\frac{\Delta f(x_0)}{h} - f'(x_0) = \frac{f''(c)h}{2}.$$

Therefore,

$$\left| \frac{\Delta f(x_0)}{h} - f'(x_0) \right| \leq \frac{M_2 h}{2},$$

where  $M_2$  is an upper bound for  $|f''|$  on  $(x_0, x_0 + h)$ .

If  $f'''$  exists on an open interval containing  $x_0$  and  $x_0 + 2h$ , we can use Theorem 2.5.4 to estimate the error in (2.5.15) by writing

$$f(x_0 + h) = f(x_0) + hf'(x_0) + \frac{h^2}{2}f''(x_0) + \frac{h^3}{6}f'''(c_0)$$

and

$$f(x_0 + 2h) = f(x_0) + 2hf'(x_0) + 2h^2f''(x_0) + \frac{4h^3}{3}f'''(c_1),$$

where  $x_0 < c_0 < x_0 + h$  and  $x_0 < c_1 < x_0 + 2h$ . These two equations imply that

$$f(x_0 + 2h) - 2f(x_0 + h) + f(x_0) = h^2 f''(x_0) + \left[ \frac{4}{3}f'''(c_1) - \frac{1}{3}f'''(c_0) \right] h^3,$$

which can be rewritten as

$$\frac{\Delta^2 f(x_0)}{h^2} - f''(x_0) = \left[ \frac{4}{3}f'''(c_1) - \frac{1}{3}f'''(c_0) \right] h,$$

because of (2.5.13). Therefore,

$$\left| \frac{\Delta^2 f(x_0)}{h^2} - f''(x_0) \right| \leq \frac{5M_3 h}{3},$$

where  $M_3$  is an upper bound for  $|f'''|$  on  $(x_0, x_0 + 2h)$ .

### The Extended Mean Value Theorem

We now consider the extended mean value theorem, which implies Theorem 2.5.4 (Exercise 2.5.24). In the following theorem,  $a$  and  $b$  are the endpoints of an interval, but we do not assume that  $a < b$ .

**Theorem 2.5.5 (Extended Mean Value Theorem)** *Suppose that  $f$  is continuous on a finite closed interval  $I$  with endpoints  $a$  and  $b$  (that is, either  $I = (a, b)$  or  $I = (b, a)$ ),  $f^{(n+1)}$  exists on the open interval  $I^0$ , and, if  $n > 0$ , that  $f', \dots, f^{(n)}$  exist and are continuous at  $a$ . Then*

$$f(b) - \sum_{r=0}^n \frac{f^{(r)}(a)}{r!} (b-a)^r = \frac{f^{(n+1)}(c)}{(n+1)!} (b-a)^{n+1} \quad (2.5.17)$$

for some  $c$  in  $I^0$ .

**Proof** The proof is by induction. The mean value theorem (Theorem 2.3.11) implies the conclusion for  $n = 0$ . Now suppose that  $n \geq 1$ , and assume that the assertion of the theorem is true with  $n$  replaced by  $n - 1$ . The left side of (2.5.17) can be written as

$$f(b) - \sum_{r=0}^n \frac{f^{(r)}(a)}{r!} (b-a)^r = K \frac{(b-a)^{n+1}}{(n+1)!} \quad (2.5.18)$$

for some number  $K$ . We must prove that  $K = f^{(n+1)}(c)$  for some  $c$  in  $I^0$ . To this end, consider the auxiliary function

$$h(x) = f(x) - \sum_{r=0}^n \frac{f^{(r)}(a)}{r!} (x-a)^r - K \frac{(x-a)^{n+1}}{(n+1)!},$$

which satisfies

$$h(a) = 0, \quad h(b) = 0,$$

(the latter because of (2.5.18)) and is continuous on the closed interval  $I$  and differentiable on  $I^0$ , with

$$h'(x) = f'(x) - \sum_{r=0}^{n-1} \frac{f^{(r+1)}(a)}{r!} (x-a)^r - K \frac{(x-a)^n}{n!}. \quad (2.5.19)$$

Therefore, Rolle's theorem (Theorem 2.3.8) implies that  $h'(b_1) = 0$  for some  $b_1$  in  $I^0$ ; thus, from (2.5.19),

$$f'(b_1) - \sum_{r=0}^{n-1} \frac{f^{(r+1)}(a)}{r!} (b_1-a)^r - K \frac{(b_1-a)^n}{n!} = 0.$$

If we temporarily write  $f' = g$ , this becomes

$$g(b_1) - \sum_{r=0}^{n-1} \frac{g^{(r)}(a)}{r!} (b_1-a)^r - K \frac{(b_1-a)^n}{n!} = 0. \quad (2.5.20)$$

Since  $b_1 \in I^0$ , the hypotheses on  $f$  imply that  $g$  is continuous on the closed interval  $J$  with endpoints  $a$  and  $b_1$ ,  $g^{(n)}$  exists on  $J^0$ , and, if  $n \geq 1$ ,  $g', \dots, g^{(n-1)}$  exist and are continuous at  $a$  (also at  $b_1$ , but this is not important). The induction hypothesis, applied to  $g$  on the interval  $J$ , implies that

$$g(b_1) - \sum_{r=0}^{n-1} \frac{g^{(r)}(a)}{r!} (b_1 - a)^r = \frac{g^{(n)}(c)}{n!} (b_1 - a)^n$$

for some  $c$  in  $J^0$ . Comparing this with (2.5.20) and recalling that  $g = f'$  yields

$$K = g^{(n)}(c) = f^{(n+1)}(c).$$

Since  $c$  is in  $I^0$ , this completes the induction. ■

## 2.5 Exercises

---

1. Let

$$f(x) = \begin{cases} e^{-1/x^2}, & x \neq 0, \\ 0, & x = 0. \end{cases}$$

Show that  $f$  has derivatives of all orders on  $(-\infty, \infty)$  and every Taylor polynomial of  $f$  about 0 is identically zero. HINT: See Exercise 2.4.40.

2. Suppose that  $f^{(n+1)}(x_0)$  exists, and let  $T_n$  be the  $n$ th Taylor polynomial of  $f$  about  $x_0$ . Show that the function

$$E_n(x) = \begin{cases} \frac{f(x) - T_n(x)}{(x - x_0)^n}, & x \in D_f - \{x_0\}, \\ 0, & x = x_0, \end{cases}$$

is differentiable at  $x_0$ , and find  $E'_n(x_0)$ .

3. (a) Prove: If  $f$  is continuous at  $x_0$  and there are constants  $a_0$  and  $a_1$  such that

$$\lim_{x \rightarrow x_0} \frac{f(x) - a_0 - a_1(x - x_0)}{x - x_0} = 0,$$

then  $a_0 = f(x_0)$ ,  $f'$  is differentiable at  $x_0$ , and  $f'(x_0) = a_1$ .

- (b) Give a counterexample to the following statement: If  $f$  and  $f'$  are continuous at  $x_0$  and there are constants  $a_0$ ,  $a_1$ , and  $a_2$  such that

$$\lim_{x \rightarrow x_0} \frac{f(x) - a_0 - a_1(x - x_0) - a_2(x - x_0)^2}{(x - x_0)^2} = 0,$$

then  $f''(x_0)$  exists.

4. (a) Prove: if  $f''(x_0)$  exists, then

$$\lim_{h \rightarrow 0} \frac{f(x_0 + h) - 2f(x_0) + f(x_0 - h)}{h^2} = f''(x_0).$$

(b) Prove or give a counterexample: If the limit in (a) exists, then so does  $f''(x_0)$ , and they are equal.

5. A function  $f$  has a *simple* zero (or a zero of *multiplicity* 1) at  $x_0$  if  $f$  is differentiable in a neighborhood of  $x_0$  and  $f(x_0) = 0$ , while  $f'(x_0) \neq 0$ .

(a) Prove that  $f$  has a simple zero at  $x_0$  if and only if

$$f(x) = g(x)(x - x_0),$$

where  $g$  is continuous at  $x_0$  and differentiable on a deleted neighborhood of  $x_0$ , and  $g(x_0) \neq 0$ .

(b) Give an example showing that  $g$  in (a) need not be differentiable at  $x_0$ .

6. A function  $f$  has a *double* zero (or a zero of *multiplicity* 2) at  $x_0$  if  $f$  is twice differentiable on a neighborhood of  $x_0$  and  $f(x_0) = f'(x_0) = 0$ , while  $f''(x_0) \neq 0$ .

(a) Prove that  $f$  has a double zero at  $x_0$  if and only if

$$f(x) = g(x)(x - x_0)^2,$$

where  $g$  is continuous at  $x_0$  and twice differentiable on a deleted neighborhood of  $x_0$ ,  $g(x_0) \neq 0$ , and

$$\lim_{x \rightarrow x_0} (x - x_0)g'(x) = 0.$$

(b) Give an example showing that  $g$  in (a) need not be differentiable at  $x_0$ .

7. Let  $n$  be a positive integer. A function  $f$  has a zero of *multiplicity*  $n$  at  $x_0$  if  $f$  is  $n$  times differentiable on a neighborhood of  $x_0$ ,  $f(x_0) = f'(x_0) = \cdots = f^{(n-1)}(x_0) = 0$  and  $f^{(n)}(x_0) \neq 0$ . Prove that  $f$  has a zero of multiplicity  $n$  at  $x_0$  if and only if

$$f(x) = g(x)(x - x_0)^n,$$

where  $g$  is continuous at  $x_0$  and  $n$  times differentiable on a deleted neighborhood of  $x_0$ ,  $g(x_0) \neq 0$ , and

$$\lim_{x \rightarrow x_0} (x - x_0)^j g^{(j)}(x) = 0, \quad 1 \leq j \leq n - 1.$$

HINT: Use Exercise 2.5.6 and induction.

8. (a) Let

$$Q(x) = \alpha_0 + \alpha_1(x - x_0) + \cdots + \alpha_n(x - x_0)^n$$

be a polynomial of degree  $\leq n$  such that

$$\lim_{x \rightarrow x_0} \frac{Q(x)}{(x - x_0)^n} = 0.$$

Show that  $\alpha_0 = \alpha_1 = \cdots = \alpha_n = 0$ .

(b) Suppose that  $f$  is  $n$  times differentiable at  $x_0$  and  $p$  is a polynomial

$$p(x) = a_0 + a_1(x - x_0) + \cdots + a_n(x - x_0)^n$$

of degree  $\leq n$  such that

$$\lim_{x \rightarrow x_0} \frac{f(x) - p(x)}{(x - x_0)^n} = 0.$$

Show that

$$a_r = \frac{f^{(r)}(x_0)}{r!} \quad \text{if } 0 \leq r \leq n;$$

that is,  $p = T_n$ , the  $n$ th Taylor polynomial of  $f$  about  $x_0$ .

9. Show that if  $f^{(n)}(x_0)$  and  $g^{(n)}(x_0)$  exist and

$$\lim_{x \rightarrow x_0} \frac{f(x) - g(x)}{(x - x_0)^n} = 0,$$

then  $f^{(r)}(x_0) = g^{(r)}(x_0)$ ,  $0 \leq r \leq n$ .

10. (a) Let  $F_n$ ,  $G_n$ , and  $H_n$  be the  $n$ th Taylor polynomials about  $x_0$  of  $f$ ,  $g$ , and their product  $h = fg$ . Show that  $H_n$  can be obtained by multiplying  $F_n$  by  $G_n$  and retaining only the powers of  $x - x_0$  through the  $n$ th. HINT: Use Exercise 2.5.8(b).

(b) Use the method suggested by (a) to compute  $h^{(r)}(x_0)$ ,  $r = 1, 2, 3, 4$ .

(i)  $h(x) = e^x \sin x, \quad x_0 = 0$

(ii)  $h(x) = (\cos \pi x/2)(\log x), \quad x_0 = 1$

(iii)  $h(x) = x^2 \cos x, \quad x_0 = \pi/2$

(iv)  $h(x) = (1 + x)^{-1} e^{-x}, \quad x_0 = 0$

11. (a) It can be shown that if  $g$  is  $n$  times differentiable at  $x$  and  $f$  is  $n$  times differentiable at  $g(x)$ , then the composite function  $h(x) = f(g(x))$  is  $n$  times differentiable at  $x$  and

$$h^{(n)}(x) = \sum_{r=1}^n f^{(r)}(g(x)) \sum_r \frac{r!}{r_1! \cdots r_n!} \left(\frac{g'(x)}{1!}\right)^{r_1} \left(\frac{g''(x)}{2!}\right)^{r_2} \cdots \left(\frac{g^{(n)}(x)}{n!}\right)^{r_n}$$

where  $\sum_r$  is over all  $n$ -tuples  $(r_1, r_2, \dots, r_n)$  of nonnegative integers such that

$$r_1 + r_2 + \cdots + r_n = r$$

and

$$r_1 + 2r_2 + \cdots + nr_n = n.$$

(This is *Faa di Bruno's formula*). However, this formula is quite complicated. Justify the following alternative method for computing the derivatives of a composite function at a point  $x_0$ :



15. Find the critical points of

$$f(x) = \frac{x^3}{3} + \frac{bx^2}{2} + cx + d$$

and identify them as local maxima, local minima, or neither.

16. Find an upper bound for the magnitude of the error in the approximation.

(a)  $\sin x \approx x, \quad |x| < \frac{\pi}{20}$

(b)  $\sqrt{1+x} \approx 1 + \frac{x}{2}, \quad |x| < \frac{1}{8}$

(c)  $\cos x \approx \frac{1}{\sqrt{2} \left[ 1 - \left( x - \frac{\pi}{4} \right) \right]}, \quad \frac{\pi}{4} < x < \frac{5\pi}{16}$

(d)  $\log x \approx (x-1) - \frac{(x-1)^2}{2} + \frac{(x-1)^3}{3}, \quad |x-1| < \frac{1}{64}$

17. Prove: If

$$T_n(x) = \sum_{r=0}^n \frac{x^r}{r!},$$

then

$$T_n(x) < T_{n+1}(x) < e^x < \left[ 1 - \frac{x^{n+1}}{(n+1)!} \right]^{-1} T_n(x)$$

if  $0 < x < [(n+1)!]^{1/(n+1)}$ .

18. The forward difference operators with spacing  $h > 0$  are defined by

$$\Delta^0 f(x) = f(x), \quad \Delta f(x) = f(x+h) - f(x),$$

$$\Delta^{n+1} f(x) = \Delta [\Delta^n f(x)], \quad n \geq 1.$$

- (a) Prove by induction on  $n$ : If  $k \geq 2$ ,  $c_1, \dots, c_k$  are constants, and  $n \geq 1$ , then

$$\Delta^n [c_1 f_1(x) + \dots + c_k f_k(x)] = c_1 \Delta^n f_1(x) + \dots + c_k \Delta^n f_k(x).$$

- (b) Prove by induction: If  $n \geq 1$ , then

$$\Delta^n f(x) = \sum_{m=0}^n (-1)^{n-m} \binom{n}{m} f(x+mh).$$

HINT: See Exercise 1.2.19.

In Exercises 2.5.19–2.5.22,  $\Delta$  is the forward difference operator with spacing  $h > 0$ .

19. Let  $m$  and  $n$  be nonnegative integers, and let  $x_0$  be any real number. Prove by induction on  $n$  that

$$\Delta^n(x - x_0)^m = \begin{cases} 0 & \text{if } 0 \leq m \leq n, \\ n!h^n & \text{if } m = n. \end{cases}$$

Does this suggest an analogy between “differencing” and differentiation?

20. Find an upper bound for the magnitude of the error in the approximation

$$f''(x_0) \approx \frac{\Delta^2 f(x_0 - h)}{h^2},$$

- (a) assuming that  $f'''$  is bounded on  $(x_0 - h, x_0 + h)$ ;  
 (b) assuming that  $f^{(4)}$  is bounded on  $(x_0 - h, x_0 + h)$ .
21. Let  $f'''$  be bounded on an open interval containing  $x_0$  and  $x_0 + 2h$ . Find a constant  $k$  such that the magnitude of the error in the approximation

$$f'(x_0) \approx \frac{\Delta f(x_0)}{h} + k \frac{\Delta^2 f(x_0)}{h^2}$$

is not greater than  $Mh^2$ , where  $M = \sup\{|f'''(c)| \mid |x_0 - c| < 2h\}$ .

22. Prove: If  $f^{(n+1)}$  is bounded on an open interval containing  $x_0$  and  $x_0 + nh$ , then

$$\left| \frac{\Delta^n f(x_0)}{h^n} - f^{(n)}(x_0) \right| \leq A_n M_{n+1} h,$$

where  $A_n$  is a constant independent of  $f$  and

$$M_{n+1} = \sup_{x_0 < c < x_0 + nh} |f^{(n+1)}(c)|.$$

HINT: See Exercises 2.5.18 and 2.5.19.

23. Suppose that  $f^{(n+1)}$  exists on  $(a, b)$ ,  $x_0, \dots, x_n$  are in  $(a, b)$ , and  $p$  is the polynomial of degree  $\leq n$  such that  $p(x_i) = f(x_i)$ ,  $0 \leq i \leq n$ . Prove: If  $x \in (a, b)$ , then

$$f(x) = p(x) + \frac{f^{(n+1)}(c)}{(n+1)!} (x - x_0)(x - x_1) \cdots (x - x_n),$$

where  $c$ , which depends on  $x$ , is in  $(a, b)$ . HINT: Let  $x$  be fixed, distinct from  $x_0, x_1, \dots, x_n$ , and consider the function

$$g(y) = f(y) - p(y) - \frac{K}{(n+1)!} (y - x_0)(y - x_1) \cdots (y - x_n),$$

where  $K$  is chosen so that  $g(x) = 0$ . Use Rolle's theorem to show that  $K = f^{(n+1)}(c)$  for some  $c$  in  $(a, b)$ .

24. Deduce Theorem 2.5.4 from Theorem 2.5.5.



## CHAPTER 3

### Integral Calculus of Functions of One Variable

IN THIS CHAPTER we discuss the Riemann on a finite interval  $[a, b]$ , and improper integrals in which either the function or the interval of integration is unbounded.

SECTION 3.1 begins with the definition of the Riemann integral and presents the geometrical interpretation of the Riemann integral as the area under a curve. We show that an unbounded function cannot be Riemann integrable. Then we define upper and lower sums and upper and lower integrals of a bounded function. The section concludes with the definition of the Riemann–Stieltjes integral.

SECTION 3.2 presents necessary and sufficient conditions for the existence of the Riemann integral in terms of upper and lower sums and upper and lower integrals. We show that continuous functions and bounded monotonic functions are Riemann integrable.

SECTION 3.3 begins with proofs that the sum and product of Riemann integrable functions are integrable, and that  $|f|$  is Riemann integrable if  $f$  is Riemann integrable. Other topics covered include the first mean value theorem for integrals, antiderivatives, the fundamental theorem of calculus, change of variables, integration by parts, and the second mean value theorem for integrals.

SECTION 3.4 presents a comprehensive discussion of improper integrals. Concepts defined and considered include absolute and conditional convergence of an improper integral, Dirichlet’s test, and change of variable in an improper integral.

SECTION 3.5 defines the notion of a set with Lebesgue measure zero, and presents a necessary and sufficient condition for a bounded function  $f$  to be Riemann integrable on an interval  $[a, b]$ ; namely, that the discontinuities of  $f$  form a set with Lebesgue measure zero.

#### 3.1 DEFINITION OF THE INTEGRAL

The integral that you studied in calculus is the *Riemann integral*, named after the German mathematician [Bernhard Riemann](#), who provided a rigorous formulation of the integral to

replace the intuitive notion due to [Newton](#) and [Leibniz](#). Since Riemann's time, other kinds of integrals have been defined and studied; however, they are all generalizations of the Riemann integral, and it is hardly possible to understand them or appreciate the reasons for developing them without a thorough understanding of the Riemann integral. In this section we deal with functions defined on a finite interval  $[a, b]$ . A *partition of  $[a, b]$*  is a set of subintervals

$$[x_0, x_1], [x_1, x_2], \dots, [x_{n-1}, x_n], \quad (3.1.1)$$

where

$$a = x_0 < x_1 < \dots < x_n = b. \quad (3.1.2)$$

Thus, any set of  $n + 1$  points satisfying (3.1.2) defines a partition  $P$  of  $[a, b]$ , which we denote by

$$P = \{x_0, x_1, \dots, x_n\}.$$

The points  $x_0, x_1, \dots, x_n$  are the *partition points* of  $P$ . The largest of the lengths of the subintervals (3.1.1) is the *norm* of  $P$ , written as  $\|P\|$ ; thus,

$$\|P\| = \max_{1 \leq i \leq n} (x_i - x_{i-1}).$$

If  $P$  and  $P'$  are partitions of  $[a, b]$ , then  $P'$  is a *refinement of  $P$*  if every partition point of  $P$  is also a partition point of  $P'$ ; that is, if  $P'$  is obtained by inserting additional points between those of  $P$ . If  $f$  is defined on  $[a, b]$ , then a sum

$$\sigma = \sum_{j=1}^n f(c_j)(x_j - x_{j-1}),$$

where

$$x_{j-1} \leq c_j \leq x_j, \quad 1 \leq j \leq n,$$

is a *Riemann sum of  $f$  over the partition  $P = \{x_0, x_1, \dots, x_n\}$* . (Occasionally we will say more simply that  $\sigma$  is a Riemann sum of  $f$  over  $[a, b]$ .) Since  $c_j$  can be chosen arbitrarily in  $[x_j, x_{j-1}]$ , there are infinitely many Riemann sums for a given function  $f$  over a given partition  $P$ .

**Definition 3.1.1** Let  $f$  be defined on  $[a, b]$ . We say that  $f$  is *Riemann integrable on  $[a, b]$*  if there is a number  $L$  with the following property: For every  $\epsilon > 0$ , there is a  $\delta > 0$  such that

$$|\sigma - L| < \epsilon$$

if  $\sigma$  is any Riemann sum of  $f$  over a partition  $P$  of  $[a, b]$  such that  $\|P\| < \delta$ . In this case, we say that  $L$  is the *Riemann integral of  $f$  over  $[a, b]$* , and write

$$\int_a^b f(x) dx = L.$$

We leave it to you (Exercise 3.1.1) to show that  $\int_a^b f(x) dx$  is unique, if it exists; that is, there cannot be more than one number  $L$  that satisfies Definition 3.1.1.

For brevity we will say “integrable” and “integral” when we mean “Riemann integrable” and “Riemann integral.” Saying that  $\int_a^b f(x) dx$  exists is equivalent to saying that  $f$  is integrable on  $[a, b]$ .

**Example 3.1.1** If

$$f(x) = 1, \quad a \leq x \leq b,$$

then

$$\sum_{j=1}^n f(c_j)(x_j - x_{j-1}) = \sum_{j=1}^n (x_j - x_{j-1}).$$

Most of the terms in the sum on the right cancel in pairs; that is,

$$\begin{aligned} \sum_{j=1}^n (x_j - x_{j-1}) &= (x_1 - x_0) + (x_2 - x_1) + \cdots + (x_n - x_{n-1}) \\ &= -x_0 + (x_1 - x_1) + (x_2 - x_2) + \cdots + (x_{n-1} - x_{n-1}) + x_n \\ &= x_n - x_0 \\ &= b - a. \end{aligned}$$

Thus, every Riemann sum of  $f$  over any partition of  $[a, b]$  equals  $b - a$ , so

$$\int_a^b dx = b - a.$$

**Example 3.1.2** Riemann sums for the function

$$f(x) = x, \quad a \leq x \leq b,$$

are of the form

$$\sigma = \sum_{j=1}^n c_j(x_j - x_{j-1}). \quad (3.1.3)$$

Since  $x_{j-1} \leq c_j \leq x_j$  and  $(x_j + x_{j-1})/2$  is the midpoint of  $[x_{j-1}, x_j]$ , we can write

$$c_j = \frac{x_j + x_{j-1}}{2} + d_j, \quad (3.1.4)$$

where

$$|d_j| \leq \frac{x_j - x_{j-1}}{2} \leq \frac{\|P\|}{2}. \quad (3.1.5)$$

Substituting (3.1.4) into (3.1.3) yields

$$\begin{aligned} \sigma &= \sum_{j=1}^n \frac{x_j + x_{j-1}}{2} (x_j - x_{j-1}) + \sum_{j=1}^n d_j (x_j - x_{j-1}) \\ &= \frac{1}{2} \sum_{j=1}^n (x_j^2 - x_{j-1}^2) + \sum_{j=1}^n d_j (x_j - x_{j-1}). \end{aligned} \quad (3.1.6)$$

Because of cancellations like those in Example 3.1.1,

$$\sum_{j=1}^n (x_j^2 - x_{j-1}^2) = b^2 - a^2,$$

so (3.1.6) can be rewritten as

$$\sigma = \frac{b^2 - a^2}{2} + \sum_{j=1}^n d_j (x_j - x_{j-1}).$$

Hence,

$$\begin{aligned} \left| \sigma - \frac{b^2 - a^2}{2} \right| &\leq \sum_{j=1}^n |d_j| (x_j - x_{j-1}) \leq \frac{\|P\|}{2} \sum_{j=1}^n (x_j - x_{j-1}) \quad (\text{see (3.1.5)}) \\ &= \frac{\|P\|}{2} (b - a). \end{aligned}$$

Therefore, every Riemann sum of  $f$  over a partition  $P$  of  $[a, b]$  satisfies

$$\left| \sigma - \frac{b^2 - a^2}{2} \right| < \epsilon \quad \text{if} \quad \|P\| < \delta = \frac{2\epsilon}{b - a}.$$

Hence,

$$\int_a^b x \, dx = \frac{b^2 - a^2}{2}.$$

### The Integral as the Area Under a Curve

An important application of the integral, indeed, the one invariably used to motivate its definition, is the computation of the area bounded by a curve  $y = f(x)$ , the  $x$ -axis, and the lines  $x = a$  and  $x = b$  (“the area under the curve”), as in Figure 3.1.1.

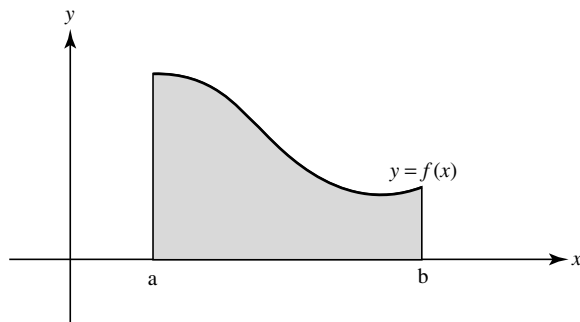


Figure 3.1.1

For simplicity, suppose that  $f(x) > 0$ . Then  $f(c_j)(x_j - x_{j-1})$  is the area of a rectangle with base  $x_j - x_{j-1}$  and height  $f(c_j)$ , so the Riemann sum

$$\sum_{j=1}^n f(c_j)(x_j - x_{j-1})$$

can be interpreted as the sum of the areas of rectangles related to the curve  $y = f(x)$ , as shown in Figure 3.1.2.

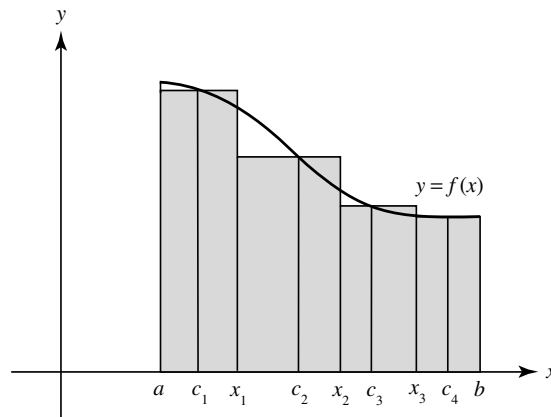


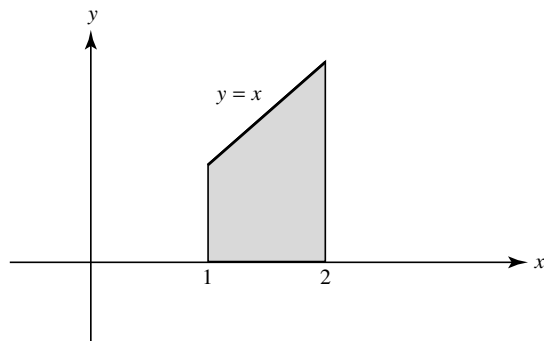
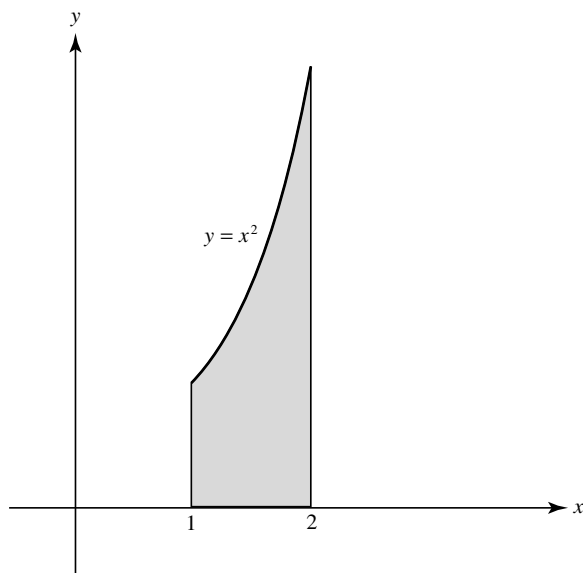
Figure 3.1.2

An apparently plausible argument, that the Riemann sums approximate the area under the curve more and more closely as the number of rectangles increases and the largest of their widths is made smaller, seems to support the assertion that  $\int_a^b f(x) dx$  equals the area under the curve. This argument is useful as a motivation for Definition 3.1.1, which without it would seem mysterious. Nevertheless, the logic is incorrect, since it is based on the assumption that the area under the curve has been previously defined in some other way. Although this is true for certain curves such as, for example, those consisting of line segments or circular arcs, it is not true in general. In fact, the area under a more complicated curve is *defined* to be equal to the integral, if the integral exists. That this new definition is consistent with the old one, where the latter applies, is evidence that the integral provides a useful generalization of the definition of area.

**Example 3.1.3** Let  $f(x) = x$ ,  $1 \leq x \leq 2$  (Figure 3.1.3, page 118). The region under the curve consists of a square of unit area, surmounted by a triangle of area  $1/2$ ; thus, the area of the region is  $3/2$ . From Example 3.1.2,

$$\int_1^2 x dx = \frac{1}{2}(2^2 - 1^2) = \frac{3}{2},$$

so the integral equals the area under the curve.

**Figure 3.1.3****Figure 3.1.4**

**Example 3.1.4** If

$$f(x) = x^2, \quad 1 \leq x \leq 2$$

(Figure 3.1.4), then

$$\int_1^2 f(x) dx = \frac{1}{3}(2^3 - 1^3) = \frac{7}{3}$$

(Exercise 3.1.4), so we say that the area under the curve is  $7/3$ . However, this is the *definition* of the area rather than a confirmation of a previously known fact, as in Example 3.1.3.

**Theorem 3.1.2** *If  $f$  is unbounded on  $[a, b]$ , then  $f$  is not integrable on  $[a, b]$ .*

**Proof** We will show that if  $f$  is unbounded on  $[a, b]$ ,  $P$  is any partition of  $[a, b]$ , and  $M > 0$ , then there are Riemann sums  $\sigma$  and  $\sigma'$  of  $f$  over  $P$  such that

$$|\sigma - \sigma'| \geq M. \quad (3.1.7)$$

We leave it to you (Exercise 3.1.2) to complete the proof by showing from this that  $f$  cannot satisfy Definition 3.1.1.

Let

$$\sigma = \sum_{j=1}^n f(c_j)(x_j - x_{j-1})$$

be a Riemann sum of  $f$  over a partition  $P$  of  $[a, b]$ . There must be an integer  $i$  in  $\{1, 2, \dots, n\}$  such that

$$|f(c) - f(c_i)| \geq \frac{M}{x_i - x_{i-1}} \quad (3.1.8)$$

for some  $c$  in  $[x_{i-1}, x_i]$ , because if there were not so, we would have

$$|f(x) - f(c_j)| < \frac{M}{x_j - x_{j-1}}, \quad x_{j-1} \leq x \leq x_j, \quad 1 \leq j \leq n.$$

Then

$$\begin{aligned} |f(x)| &= |f(c_j) + f(x) - f(c_j)| \leq |f(c_j)| + |f(x) - f(c_j)| \\ &\leq |f(c_j)| + \frac{M}{x_j - x_{j-1}}, \quad x_{j-1} \leq x \leq x_j, \quad 1 \leq j \leq n. \end{aligned}$$

which implies that

$$|f(x)| \leq \max_{1 \leq j \leq n} |f(c_j)| + \frac{M}{x_j - x_{j-1}}, \quad a \leq x \leq b,$$

contradicting the assumption that  $f$  is unbounded on  $[a, b]$ .

Now suppose that  $c$  satisfies (3.1.8), and consider the Riemann sum

$$\sigma' = \sum_{j=1}^n f(c'_j)(x_j - x_{j-1})$$

over the same partition  $P$ , where

$$c'_j = \begin{cases} c_j, & j \neq i, \\ c, & j = i. \end{cases}$$

Since

$$|\sigma - \sigma'| = |f(c) - f(c_i)|(x_i - x_{i-1}),$$

(3.1.8) implies (3.1.7). ■

### Upper and Lower Integrals

Because of Theorem 3.1.2, we consider only bounded functions throughout the rest of this section.

To prove directly from Definition 3.1.1 that  $\int_a^b f(x) dx$  exists, it is necessary to discover its value  $L$  in one way or another and to show that  $L$  has the properties required by the definition. For a specific function it may happen that this can be done by straightforward calculation, as in Examples 3.1.1 and 3.1.2. However, this is not so if the objective is to find general conditions which imply that  $\int_a^b f(x) dx$  exists. The following approach avoids the difficulty of having to discover  $L$  in advance, without knowing whether it exists in the first place, and requires only that we compare two numbers that must exist if  $f$  is bounded on  $[a, b]$ . We will see that  $\int_a^b f(x) dx$  exists if and only if these two numbers are equal.

**Definition 3.1.3** If  $f$  is bounded on  $[a, b]$  and  $P = \{x_0, x_1, \dots, x_n\}$  is a partition of  $[a, b]$ , let

$$M_j = \sup_{x_{j-1} \leq x \leq x_j} f(x)$$

and

$$m_j = \inf_{x_{j-1} \leq x \leq x_j} f(x).$$

The *upper sum of  $f$  over  $P$*  is

$$S(P) = \sum_{j=1}^n M_j (x_j - x_{j-1}),$$

and the *upper integral of  $f$  over  $[a, b]$* , denoted by

$$\overline{\int_a^b} f(x) dx,$$

is the infimum of all upper sums. The *lower sum of  $f$  over  $P$*  is

$$s(P) = \sum_{j=1}^n m_j (x_j - x_{j-1}),$$

and the *lower integral of  $f$  over  $[a, b]$* , denoted by

$$\underline{\int_a^b} f(x) dx,$$

is the supremum of all lower sums. ■



If  $m \leq f(x) \leq M$  for all  $x$  in  $[a, b]$ , then

$$m(b-a) \leq s(P) \leq S(P) \leq M(b-a)$$

for every partition  $P$ ; thus, the set of upper sums of  $f$  over all partitions  $P$  of  $[a, b]$  is bounded, as is the set of lower sums. Therefore, Theorems 1.1.3 and 1.1.8 imply that  $\int_a^b f(x) dx$  and  $\int_a^b f(x) dx$  exist, are unique, and satisfy the inequalities

$$m(b-a) \leq \int_a^b f(x) dx \leq M(b-a)$$

and

$$m(b-a) \leq \int_a^b f(x) dx \leq M(b-a).$$

**Theorem 3.1.4** Let  $f$  be bounded on  $[a, b]$ , and let  $P$  be a partition of  $[a, b]$ . Then

- (a) The upper sum  $S(P)$  of  $f$  over  $P$  is the supremum of the set of all Riemann sums of  $f$  over  $P$ .  
 (b) The lower sum  $s(P)$  of  $f$  over  $P$  is the infimum of the set of all Riemann sums of  $f$  over  $P$ .

**Proof** (a) If  $P = \{x_0, x_1, \dots, x_n\}$ , then

$$S(P) = \sum_{j=1}^n M_j(x_j - x_{j-1}),$$

where

$$M_j = \sup_{x_{j-1} \leq x \leq x_j} f(x).$$

An arbitrary Riemann sum of  $f$  over  $P$  is of the form

$$\sigma = \sum_{j=1}^n f(c_j)(x_j - x_{j-1}),$$

where  $x_{j-1} \leq c_j \leq x_j$ . Since  $f(c_j) \leq M_j$ , it follows that  $\sigma \leq S(P)$ .

Now let  $\epsilon > 0$  and choose  $\bar{c}_j$  in  $[x_{j-1}, x_j]$  so that

$$f(\bar{c}_j) > M_j - \frac{\epsilon}{n(x_j - x_{j-1})}, \quad 1 \leq j \leq n.$$

The Riemann sum produced in this way is

$$\bar{\sigma} = \sum_{j=1}^n f(\bar{c}_j)(x_j - x_{j-1}) > \sum_{j=1}^n \left[ M_j - \frac{\epsilon}{n(x_j - x_{j-1})} \right] (x_j - x_{j-1}) = S(P) - \epsilon.$$

Now Theorem 1.1.3 implies that  $S(P)$  is the supremum of the set of Riemann sums of  $f$  over  $P$ .

(b) Exercise 3.1.7. ■

**Example 3.1.5** Let

$$f(x) = \begin{cases} 0 & \text{if } x \text{ is irrational,} \\ 1 & \text{if } x \text{ is rational,} \end{cases}$$

and  $P = \{x_0, x_1, \dots, x_n\}$  be a partition of  $[a, b]$ . Since every interval contains both rational and irrational numbers (Theorems 1.1.6 and 1.1.7),

$$m_j = 0 \quad \text{and} \quad M_j = 1, \quad 1 \leq j \leq n.$$

Hence,

$$S(P) = \sum_{j=1}^n 1 \cdot (x_j - x_{j-1}) = b - a$$

and

$$s(P) = \sum_{j=1}^n 0 \cdot (x_j - x_{j-1}) = 0.$$

Since all upper sums equal  $b - a$  and all lower sums equal 0, Definition 3.1.3 implies that

$$\overline{\int_a^b} f(x) dx = b - a \quad \text{and} \quad \underline{\int_a^b} f(x) dx = 0.$$

**Example 3.1.6** Let  $f$  be defined on  $[1, 2]$  by  $f(x) = 0$  if  $x$  is irrational and  $f(p/q) = 1/q$  if  $p$  and  $q$  are positive integers with no common factors (Exercise 2.2.7). If  $P = \{x_0, x_1, \dots, x_n\}$  is any partition of  $[1, 2]$ , then  $m_j = 0$ ,  $1 \leq j \leq n$ , so  $s(P) = 0$ ; hence,

$$\underline{\int_1^2} f(x) dx = 0.$$

We now show that

$$\overline{\int_1^2} f(x) dx = 0 \tag{3.1.9}$$

also. Since  $S(P) > 0$  for every  $P$ , Definition 3.1.3 implies that

$$\overline{\int_1^2} f(x) dx \geq 0,$$

so we need only show that

$$\overline{\int_1^2} f(x) dx \leq 0,$$

which will follow if we show that no positive number is less than every upper sum. To this end, we observe that if  $0 < \epsilon < 2$ , then  $f(x) \geq \epsilon/2$  for only finitely many values of  $x$  in  $[1, 2]$ .

Let  $k$  be the number of such points and let  $P_0$  be a partition of  $[1, 2]$  such that

$$\|P_0\| < \frac{\epsilon}{2k}. \tag{3.1.10}$$

Consider the upper sum

$$S(P_0) = \sum_{j=1}^n M_j (x_j - x_{j-1}).$$

There are at most  $k$  values of  $j$  in this sum for which  $M_j \geq \epsilon/2$ , and  $M_j \leq 1$  even for these. The contribution of these terms to the sum is less than  $k(\epsilon/2k) = \epsilon/2$ , because of (3.1.10). Since  $M_j < \epsilon/2$  for all other values of  $j$ , the sum of the other terms is less than

$$\frac{\epsilon}{2} \sum_{j=1}^n (x_j - x_{j-1}) = \frac{\epsilon}{2} (x_n - x_0) = \frac{\epsilon}{2} (2 - 1) = \frac{\epsilon}{2}.$$

Therefore,  $S(P_0) < \epsilon$  and, since  $\epsilon$  can be chosen as small as we wish, no positive number is less than all upper sums. This proves (3.1.9). ■

The motivation for Definition 3.1.3 can be seen by again considering the idea of area under a curve. Figure 3.1.5 shows the graph of a positive function  $y = f(x)$ ,  $a \leq x \leq b$ , with  $[a, b]$  partitioned into four subintervals.

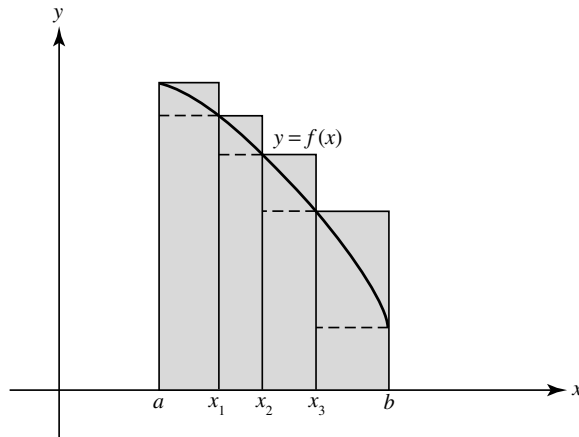


Figure 3.1.5

The upper and lower sums of  $f$  over this partition can be interpreted as the sums of the areas of the rectangles surmounted by the solid and dashed lines, respectively. This indicates that a sensible definition of area  $A$  under the curve must admit the inequalities

$$s(P) \leq A \leq S(P)$$

for every partition  $P$  of  $[a, b]$ . Thus,  $A$  must be an upper bound for all lower sums and a lower bound for all upper sums of  $f$  over partitions of  $[a, b]$ . If

$$\overline{\int_a^b} f(x) dx = \underline{\int_a^b} f(x) dx, \quad (3.1.11)$$

there is only one number, the common value of the upper and lower integrals, with this property, and we define  $A$  to be that number; if (3.1.11) does not hold, then  $A$  is not defined. We will see below that this definition of area is consistent with the definition stated earlier in terms of Riemann sums.

**Example 3.1.7** Returning to Example 3.1.3, consider the function

$$f(x) = x, \quad 1 \leq x \leq 2.$$

If  $P = \{x_0, x_1, \dots, x_n\}$  is a partition of  $[1, 2]$ , then, since  $f$  is increasing,

$$M_j = f(x_j) = x_j \quad \text{and} \quad m_j = f(x_{j-1}) = x_{j-1}.$$

Hence,

$$S(P) = \sum_{j=1}^n x_j(x_j - x_{j-1}) \quad (3.1.12)$$

and

$$s(P) = \sum_{j=1}^n x_{j-1}(x_j - x_{j-1}). \quad (3.1.13)$$

By writing

$$x_j = \frac{x_j + x_{j-1}}{2} + \frac{x_j - x_{j-1}}{2},$$

we see from (3.1.12) that

$$\begin{aligned} S(P) &= \frac{1}{2} \sum_{j=1}^n (x_j^2 - x_{j-1}^2) + \frac{1}{2} \sum_{j=1}^n (x_j - x_{j-1})^2 \\ &= \frac{1}{2} (2^2 - 1^2) + \frac{1}{2} \sum_{j=1}^n (x_j - x_{j-1})^2. \end{aligned} \quad (3.1.14)$$

Since

$$0 < \sum_{j=1}^n (x_j - x_{j-1})^2 \leq \|P\| \sum_{j=1}^n (x_j - x_{j-1}) = \|P\|(2 - 1),$$

(3.1.14) implies that

$$\frac{3}{2} < S(P) \leq \frac{3}{2} + \frac{\|P\|}{2}.$$

Since  $\|P\|$  can be made as small as we please, Definition 3.1.3 implies that

$$\int_a^b f(x) dx = \frac{3}{2}.$$

A similar argument starting from (3.1.13) shows that

$$\frac{3}{2} - \frac{\|P\|}{2} \leq s(P) < \frac{3}{2},$$

so

$$\int_a^b f(x) dx = \frac{3}{2}.$$

Since the upper and lower integrals both equal  $3/2$ , the area under the curve is  $3/2$  according to our new definition. This is consistent with the result in Example 3.1.3.

### The Riemann–Stieltjes Integral

The *Riemann–Stieltjes integral* is an important generalization of the Riemann integral. We define it here, but confine our study of it to the exercises in this and other sections of this chapter.

**Definition 3.1.5** Let  $f$  and  $g$  be defined on  $[a, b]$ . We say that  $f$  is *Riemann–Stieltjes integrable with respect to  $g$  on  $[a, b]$*  if there is a number  $L$  with the following property: For every  $\epsilon > 0$ , there is a  $\delta > 0$  such that

$$\left| \sum_{j=1}^n f(c_j) [g(x_j) - g(x_{j-1})] - L \right| < \epsilon, \quad (3.1.15)$$

provided only that  $P = \{x_0, x_1, \dots, x_n\}$  is a partition of  $[a, b]$  such that  $\|P\| < \delta$  and

$$x_{j-1} \leq c_j \leq x_j, \quad j = 1, 2, \dots, n.$$

In this case, we say that  $L$  is *the Riemann–Stieltjes integral of  $f$  with respect to  $g$  over  $[a, b]$* , and write

$$\int_a^b f(x) dg(x) = L.$$

The sum

$$\sum_{j=1}^n f(c_j) [g(x_j) - g(x_{j-1})]$$

in (3.1.15) is a *Riemann–Stieltjes sum of  $f$  with respect to  $g$  over the partition  $P$* .

### 3.1 Exercises

1. Show that there cannot be more than one number  $L$  that satisfies Definition 3.1.1.
2. (a) Prove: If  $\int_a^b f(x) dx$  exists, then for every  $\epsilon > 0$ , there is a  $\delta > 0$  such that  $|\sigma_1 - \sigma_2| < \epsilon$  if  $\sigma_1$  and  $\sigma_2$  are Riemann sums of  $f$  over partitions  $P_1$  and  $P_2$  of  $[a, b]$  with norms less than  $\delta$ .

- (b) Suppose that there is an  $M > 0$  such that, for every  $\delta > 0$ , there are Riemann sums  $\sigma_1$  and  $\sigma_2$  over a partition  $P$  of  $[a, b]$  with  $\|P\| < \delta$  such that  $|\sigma_1 - \sigma_2| \geq M$ . Use (a) to prove that  $f$  is not integrable over  $[a, b]$ .
3. Suppose that  $\int_a^b f(x) dx$  exists and there is a number  $A$  such that, for every  $\epsilon > 0$  and  $\delta > 0$ , there is a partition  $P$  of  $[a, b]$  with  $\|P\| < \delta$  and a Riemann sum  $\sigma$  of  $f$  over  $P$  that satisfies the inequality  $|\sigma - A| < \epsilon$ . Show that  $\int_a^b f(x) dx = A$ .
4. Prove directly from Definition 3.1.1 that

$$\int_a^b x^2 dx = \frac{b^3 - a^3}{3}.$$

Do not assume in advance that the integral exists. The proof of this is part of the problem. HINT: Let  $P = \{x_0, x_2, \dots, x_n\}$  be an arbitrary partition of  $[a, b]$ . Use the mean value theorem to show that

$$\frac{b^3 - a^3}{3} = \sum_{j=1}^n d_j^2 (x_j - x_{j-1})$$

for some points  $d_1, \dots, d_n$ , where  $x_{j-1} < d_j < x_j$ . Then relate this sum to arbitrary Riemann sums for  $f(x) = x^2$  over  $P$ .

5. Generalize the proof of Exercise 3.1.4 to show directly from Definition 3.1.1 that

$$\int_a^b x^m dx = \frac{b^{m+1} - a^{m+1}}{m+1}$$

if  $m$  is an integer  $\geq 0$ .

6. Prove directly from Definition 3.1.1 that  $f(x)$  is integrable on  $[a, b]$  if and only if  $f(-x)$  is integrable on  $[-b, -a]$ , and, in this case,

$$\int_a^b f(x) dx = \int_{-b}^{-a} f(-x) dx.$$

7. Let  $f$  be bounded on  $[a, b]$  and let  $P$  be a partition of  $[a, b]$ . Prove: The lower sum  $s(P)$  of  $f$  over  $P$  is the infimum of the set of all Riemann sums of  $f$  over  $P$ .
8. Let  $f$  be defined on  $[a, b]$  and let  $P = \{x_0, x_1, \dots, x_n\}$  be a partition of  $[a, b]$ .
- (a) Prove: If  $f$  is continuous on  $[a, b]$ , then  $s(P)$  and  $S(P)$  are Riemann sums of  $f$  over  $P$ .
- (b) Name another class of functions for which the conclusion of (a) is valid.
- (c) Give an example where  $s(P)$  and  $S(P)$  are not Riemann sums of  $f$  over  $P$ .

9. Find  $\int_0^1 f(x) dx$  and  $\overline{\int_0^1} f(x) dx$  if

$$(a) f(x) = \begin{cases} x & \text{if } x \text{ is rational,} \\ -x & \text{if } x \text{ is irrational.} \end{cases} \quad (b) f(x) = \begin{cases} 1 & \text{if } x \text{ is rational,} \\ x & \text{if } x \text{ is irrational.} \end{cases}$$

10. Given that  $\int_a^b e^x dx$  exists, evaluate it by using the formula

$$1 + r + r^2 + \cdots + r^n = \frac{1 - r^{n+1}}{1 - r} \quad (r \neq 1)$$

to calculate certain Riemann sums. HINT: See Exercise 3.1.3.

11. Given that  $\int_0^b \sin x dx$  exists, evaluate it by using the identity

$$\cos(j-1)\theta - \cos(j+1)\theta = 2 \sin \theta \sin j\theta$$

to calculate certain Riemann sums. HINT: See Exercise 3.1.3.

12. Given that  $\int_0^b \cos x dx$  exists, evaluate it by using the identity

$$\sin(j+1)\theta - \sin(j-1)\theta = 2 \sin \theta \cos j\theta$$

to calculate certain Riemann sums. HINT: See Exercise 3.1.3.

13. Show that if  $g(x) = x + c$  ( $c = \text{constant}$ ), then  $\int_a^b f(x) dg(x)$  exists if and only if  $\int_a^b f(x) dx$  exists, in which case

$$\int_a^b f(x) dg(x) = \int_a^b f(x) dx.$$

14. Suppose that  $-\infty < a < d < c < \infty$  and

$$g(x) = \begin{cases} g_1, & a < x < d, \\ g_2, & d < x < b, \end{cases} \quad (g_1, g_2 = \text{constants}),$$

and let  $g(a)$ ,  $g(b)$ , and  $g(d)$  be arbitrary. Suppose that  $f$  is defined on  $[a, b]$ , continuous from the right at  $a$  and from the left at  $b$ , and continuous at  $d$ . Show that  $\int_a^b f(x) dg(x)$  exists, and find its value.

15. Suppose that  $-\infty < a = a_0 < a_1 < \cdots < a_p = b < \infty$ , let  $g(x) = g_m$  (constant) on  $(a_{m-1}, a_m)$ ,  $1 \leq m \leq p$ , and let  $g(a_0), g(a_1), \dots, g(a_p)$  be arbitrary. Suppose that  $f$  is defined on  $[a, b]$ , continuous from the right at  $a$  and from the left at  $b$ , and continuous at  $a_1, a_2, \dots, a_{p-1}$ . Evaluate  $\int_a^b f(x) dg(x)$ . HINT: See Exercise 3.1.14.

16. (a) Give an example where  $\int_a^b f(x) dg(x)$  exists even though  $f$  is unbounded on  $[a, b]$ . (Thus, the analog of Theorem 3.1.2 does not hold for the Riemann–Stieltjes integral.)

(b) State and prove an analog of Theorem 3.1.2 for the case where  $g$  is increasing.

17. For the case where  $g$  is nondecreasing and  $f$  is bounded on  $[a, b]$ , define upper and lower Riemann–Stieltjes integrals in a way analogous to Definition 3.1.3.

### 3.2 EXISTENCE OF THE INTEGRAL

The following lemma is the starting point for our study of the integrability of a bounded function  $f$  on a closed interval  $[a, b]$ .

**Lemma 3.2.1** *Suppose that*

$$|f(x)| \leq M, \quad a \leq x \leq b, \quad (3.2.1)$$

and let  $P'$  be a partition of  $[a, b]$  obtained by adding  $r$  points to a partition  $P = \{x_0, x_1, \dots, x_n\}$  of  $[a, b]$ . Then

$$S(P) \geq S(P') \geq S(P) - 2Mr\|P\| \quad (3.2.2)$$

and

$$s(P) \leq s(P') \leq s(P) + 2Mr\|P\|. \quad (3.2.3)$$

**Proof** We will prove (3.2.2) and leave the proof of (3.2.3) to you (Exercise 3.2.1). First suppose that  $r = 1$ , so  $P'$  is obtained by adding one point  $c$  to the partition  $P = \{x_0, x_1, \dots, x_n\}$ ; then  $x_{i-1} < c < x_i$  for some  $i$  in  $\{1, 2, \dots, n\}$ . If  $j \neq i$ , the product  $M_j(x_j - x_{j-1})$  appears in both  $S(P)$  and  $S(P')$  and cancels out of the difference  $S(P) - S(P')$ . Therefore, if

$$M_{i1} = \sup_{x_{i-1} \leq x \leq c} f(x) \quad \text{and} \quad M_{i2} = \sup_{c \leq x \leq x_i} f(x),$$

then

$$\begin{aligned} S(P) - S(P') &= M_i(x_i - x_{i-1}) - M_{i1}(c - x_{i-1}) - M_{i2}(x_i - c) \\ &= (M_i - M_{i1})(c - x_{i-1}) + (M_i - M_{i2})(x_i - c). \end{aligned} \quad (3.2.4)$$

Since (3.2.1) implies that

$$0 \leq M_i - M_{ir} \leq 2M, \quad r = 1, 2,$$

(3.2.4) implies that

$$0 \leq S(P) - S(P') \leq 2M(x_i - x_{i-1}) \leq 2M\|P\|.$$

This proves (3.2.2) for  $r = 1$ .

Now suppose that  $r > 1$  and  $P'$  is obtained by adding points  $c_1, c_2, \dots, c_r$  to  $P$ . Let  $P^{(0)} = P$  and, for  $j \geq 1$ , let  $P^{(j)}$  be the partition of  $[a, b]$  obtained by adding  $c_j$  to  $P^{(j-1)}$ . Then the result just proved implies that

$$0 \leq S(P^{(j-1)}) - S(P^{(j)}) \leq 2M\|P^{(j-1)}\|, \quad 1 \leq j \leq r.$$



Adding these inequalities and taking account of cancellations yields

$$0 \leq S(P^{(0)}) - S(P^{(r)}) \leq 2M(\|P^{(0)}\| + \|P^{(1)}\| + \cdots + \|P^{(r-1)}\|). \quad (3.2.5)$$

Since  $P^{(0)} = P$ ,  $P^{(r)} = P'$ , and  $\|P^{(k)}\| \leq \|P^{(k-1)}\|$  for  $1 \leq k \leq r-1$ , (3.2.5) implies that

$$0 \leq S(P) - S(P') \leq 2Mr\|P\|,$$

which is equivalent to (3.2.2). ■

**Theorem 3.2.2** *If  $f$  is bounded on  $[a, b]$ , then*

$$\int_a^b f(x) dx \leq \overline{\int_a^b f(x) dx}. \quad (3.2.6)$$

**Proof** Suppose that  $P_1$  and  $P_2$  are partitions of  $[a, b]$  and  $P'$  is a refinement of both. Letting  $P = P_1$  in (3.2.3) and  $P = P_2$  in (3.2.2) shows that

$$s(P_1) \leq s(P') \quad \text{and} \quad S(P') \leq S(P_2).$$

Since  $s(P') \leq S(P')$ , this implies that  $s(P_1) \leq S(P_2)$ . Thus, every lower sum is a lower bound for the set of all upper sums. Since  $\overline{\int_a^b f(x) dx}$  is the infimum of this set, it follows that

$$s(P_1) \leq \overline{\int_a^b f(x) dx}$$

for every partition  $P_1$  of  $[a, b]$ . This means that  $\overline{\int_a^b f(x) dx}$  is an upper bound for the set of all lower sums. Since  $\int_a^b f(x) dx$  is the supremum of this set, this implies (3.2.6). ■

**Theorem 3.2.3** *If  $f$  is integrable on  $[a, b]$ , then*

$$\int_a^b f(x) dx = \overline{\int_a^b f(x) dx} = \int_a^b f(x) dx.$$

**Proof** We prove that  $\overline{\int_a^b f(x) dx} = \int_a^b f(x) dx$  and leave it to you to show that  $\int_a^b f(x) dx = \int_a^b f(x) dx$  (Exercise 3.2.2).

Suppose that  $P$  is a partition of  $[a, b]$  and  $\sigma$  is a Riemann sum of  $f$  over  $P$ . Since

$$\begin{aligned} \overline{\int_a^b f(x) dx} - \int_a^b f(x) dx &= \left( \overline{\int_a^b f(x) dx} - S(P) \right) + (S(P) - \sigma) \\ &\quad + \left( \sigma - \int_a^b f(x) dx \right), \end{aligned}$$

the triangle inequality implies that

$$\left| \overline{\int_a^b} f(x) dx - \int_a^b f(x) dx \right| \leq \left| \overline{\int_a^b} f(x) dx - S(P) \right| + |S(P) - \sigma| + \left| \sigma - \int_a^b f(x) dx \right|. \quad (3.2.7)$$

Now suppose that  $\epsilon > 0$ . From Definition 3.1.3, there is a partition  $P_0$  of  $[a, b]$  such that

$$\overline{\int_a^b} f(x) dx \leq S(P_0) < \overline{\int_a^b} f(x) dx + \frac{\epsilon}{3}. \quad (3.2.8)$$

From Definition 3.1.1, there is a  $\delta > 0$  such that

$$\left| \sigma - \int_a^b f(x) dx \right| < \frac{\epsilon}{3} \quad (3.2.9)$$

if  $\|P\| < \delta$ . Now suppose that  $\|P\| < \delta$  and  $P$  is a refinement of  $P_0$ . Since  $S(P) \leq S(P_0)$  by Lemma 3.2.1, (3.2.8) implies that

$$\overline{\int_a^b} f(x) dx \leq S(P) < \overline{\int_a^b} f(x) dx + \frac{\epsilon}{3},$$

so

$$\left| S(P) - \overline{\int_a^b} f(x) dx \right| < \frac{\epsilon}{3} \quad (3.2.10)$$

in addition to (3.2.9). Now (3.2.7), (3.2.9), and (3.2.10) imply that

$$\left| \overline{\int_a^b} f(x) dx - \int_a^b f(x) dx \right| < \frac{2\epsilon}{3} + |S(P) - \sigma| \quad (3.2.11)$$

for every Riemann sum  $\sigma$  of  $f$  over  $P$ . Since  $S(P)$  is the supremum of these Riemann sums (Theorem 3.1.4), we may choose  $\sigma$  so that

$$|S(P) - \sigma| < \frac{\epsilon}{3}.$$

Now (3.2.11) implies that

$$\left| \overline{\int_a^b} f(x) dx - \int_a^b f(x) dx \right| < \epsilon.$$

Since  $\epsilon$  is an arbitrary positive number, it follows that

$$\overline{\int_a^b} f(x) dx = \int_a^b f(x) dx.$$

■

**Lemma 3.2.4** *If  $f$  is bounded on  $[a, b]$  and  $\epsilon > 0$ , there is a  $\delta > 0$  such that*

$$\int_a^{\overline{b}} f(x) dx \leq S(P) < \int_a^{\overline{b}} f(x) dx + \epsilon \quad (3.2.12)$$

and

$$\int_a^{\underline{b}} f(x) dx \geq s(P) > \int_a^{\underline{b}} f(x) dx - \epsilon$$

if  $\|P\| < \delta$ .

**Proof** We show that (3.2.12) holds if  $\|P\|$  is sufficiently small, and leave the rest of the proof to you (Exercise 3.2.3).

The first inequality in (3.2.12) follows immediately from Definition 3.1.3. To establish the second inequality, suppose that  $|f(x)| \leq K$  if  $a \leq x \leq b$ . From Definition 3.1.3, there is a partition  $P_0 = \{x_0, x_1, \dots, x_{r+1}\}$  of  $[a, b]$  such that

$$S(P_0) < \int_a^{\overline{b}} f(x) dx + \frac{\epsilon}{2}. \quad (3.2.13)$$

If  $P$  is any partition of  $[a, b]$ , let  $P'$  be constructed from the partition points of  $P_0$  and  $P$ . Then

$$S(P') \leq S(P_0), \quad (3.2.14)$$

by Lemma 3.2.1. Since  $P'$  is obtained by adding at most  $r$  points to  $P$ , Lemma 3.2.1 implies that

$$S(P') \geq S(P) - 2Kr\|P\|. \quad (3.2.15)$$

Now (3.2.13), (3.2.14), and (3.2.15) imply that

$$\begin{aligned} S(P) &\leq S(P') + 2Kr\|P\| \\ &\leq S(P_0) + 2Kr\|P\| \\ &< \int_a^{\overline{b}} f(x) dx + \frac{\epsilon}{2} + 2Kr\|P\|. \end{aligned}$$

Therefore, (3.2.12) holds if

$$\|P\| < \delta = \frac{\epsilon}{4Kr}.$$

■

**Theorem 3.2.5** *If  $f$  is bounded on  $[a, b]$  and*

$$\int_a^b f(x) dx = \overline{\int_a^b f(x) dx} = L, \quad (3.2.16)$$

*then  $f$  is integrable on  $[a, b]$  and*

$$\int_a^b f(x) dx = L. \quad (3.2.17)$$

**Proof** If  $\epsilon > 0$ , there is a  $\delta > 0$  such that

$$\int_a^b f(x) dx - \epsilon < s(P) \leq S(P) < \overline{\int_a^b} f(x) dx + \epsilon \quad (3.2.18)$$

if  $\|P\| < \delta$  (Lemma 3.2.4). If  $\sigma$  is a Riemann sum of  $f$  over  $P$ , then

$$s(P) \leq \sigma \leq S(P),$$

so (3.2.16) and (3.2.18) imply that

$$L - \epsilon < \sigma < L + \epsilon$$

if  $\|P\| < \delta$ . Now Definition 3.1.1 implies (3.2.17). ■

Theorems 3.2.3 and 3.2.5 imply the following theorem.

**Theorem 3.2.6** *A bounded function  $f$  is integrable on  $[a, b]$  if and only if*

$$\int_a^b f(x) dx = \overline{\int_a^b} f(x) dx.$$

The next theorem translates this into a test that can be conveniently applied.

**Theorem 3.2.7** *If  $f$  is bounded on  $[a, b]$ , then  $f$  is integrable on  $[a, b]$  if and only if for each  $\epsilon > 0$  there is a partition  $P$  of  $[a, b]$  for which*

$$S(P) - s(P) < \epsilon. \quad (3.2.19)$$

**Proof** We leave it to you (Exercise 3.2.4) to show that if  $\int_a^b f(x) dx$  exists, then (3.2.19) holds for  $\|P\|$  sufficiently small. This implies that the stated condition is necessary for integrability. To show that it is sufficient, we observe that since

$$s(P) \leq \int_a^b f(x) dx \leq \overline{\int_a^b} f(x) dx \leq S(P)$$

for all  $P$ , (3.2.19) implies that

$$0 \leq \overline{\int_a^b} f(x) dx - \int_a^b f(x) dx < \epsilon.$$

Since  $\epsilon$  can be any positive number, this implies that

$$\overline{\int_a^b} f(x) dx = \int_a^b f(x) dx.$$

Therefore,  $\int_a^b f(x) dx$  exists, by Theorem 3.2.5. ■

The next two theorems are important applications of Theorem 3.2.7.

**Theorem 3.2.8** *If  $f$  is continuous on  $[a, b]$ , then  $f$  is integrable on  $[a, b]$ .*

**Proof** Let  $P = \{x_0, x_1, \dots, x_n\}$  be a partition of  $[a, b]$ . Since  $f$  is continuous on  $[a, b]$ , there are points  $c_j$  and  $c'_j$  in  $[x_{j-1}, x_j]$  such that

$$f(c_j) = M_j = \sup_{x_{j-1} \leq x \leq x_j} f(x)$$

and

$$f(c'_j) = m_j = \inf_{x_{j-1} \leq x \leq x_j} f(x)$$

(Theorem 2.2.9). Therefore,

$$S(P) - s(P) = \sum_{j=1}^n [f(c_j) - f(c'_j)](x_j - x_{j-1}). \quad (3.2.20)$$

Since  $f$  is uniformly continuous on  $[a, b]$  (Theorem 2.2.12), there is for each  $\epsilon > 0$  a  $\delta > 0$  such that

$$|f(x') - f(x)| < \frac{\epsilon}{b-a}$$

if  $x$  and  $x'$  are in  $[a, b]$  and  $|x - x'| < \delta$ . If  $\|P\| < \delta$ , then  $|c_j - c'_j| < \delta$  and, from (3.2.20),

$$S(P) - s(P) < \frac{\epsilon}{b-a} \sum_{j=1}^n (x_j - x_{j-1}) = \epsilon.$$

Hence,  $f$  is integrable on  $[a, b]$ , by Theorem 3.2.7. ■

**Theorem 3.2.9** *If  $f$  is monotonic on  $[a, b]$ , then  $f$  is integrable on  $[a, b]$ .*

**Proof** Let  $P = \{x_0, x_1, \dots, x_n\}$  be a partition of  $[a, b]$ . Since  $f$  is nondecreasing,

$$f(x_j) = M_j = \sup_{x_{j-1} \leq x \leq x_j} f(x)$$

and

$$f(x_{j-1}) = m_j = \inf_{x_{j-1} \leq x \leq x_j} f(x).$$

Hence,

$$S(P) - s(P) = \sum_{j=1}^n (f(x_j) - f(x_{j-1}))(x_j - x_{j-1}).$$

Since  $0 < x_j - x_{j-1} \leq \|P\|$  and  $f(x_j) - f(x_{j-1}) \geq 0$ ,

$$\begin{aligned} S(P) - s(P) &\leq \|P\| \sum_{j=1}^n (f(x_j) - f(x_{j-1})) \\ &= \|P\| (f(b) - f(a)). \end{aligned}$$

Therefore,

$$S(P) - s(P) < \epsilon \quad \text{if} \quad \|P\|(f(b) - f(a)) < \epsilon,$$

so  $f$  is integrable on  $[a, b]$ , by Theorem 3.2.7.

The proof for nonincreasing  $f$  is similar. ■

We will also use Theorem 3.2.7 in the next section to establish properties of the integral. In Section 3.5 we will study more general conditions for integrability.

### 3.2 Exercises

---

1. Complete the proof of Lemma 3.2.1 by verifying Eqn. (3.2.3).
2. Show that if  $f$  is integrable on  $[a, b]$ , then

$$\int_a^b f(x) dx = \int_a^b f(x) dx.$$

3. Prove: If  $f$  is bounded on  $[a, b]$ , there is for each  $\epsilon > 0$  a  $\delta > 0$  such that

$$\int_a^b f(x) dx \geq \int_a^b f(x) dx - \epsilon < s(P)$$

if  $\|P\| < \delta$ .

4. Prove: If  $f$  is integrable on  $[a, b]$  and  $\epsilon > 0$ , then  $S(P) - s(P) < \epsilon$  if  $\|P\|$  is sufficiently small. HINT: Use Theorem 3.1.4.
5. Suppose that  $f$  is integrable and  $g$  is bounded on  $[a, b]$ , and  $g$  differs from  $f$  only at points in a set  $H$  with the following property: For each  $\epsilon > 0$ ,  $H$  can be covered by a finite number of closed subintervals of  $[a, b]$ , the sum of whose lengths is less than  $\epsilon$ . Show that  $g$  is integrable on  $[a, b]$  and that

$$\int_a^b g(x) dx = \int_a^b f(x) dx.$$

HINT: Use Exercise 3.1.3.

6. Suppose that  $g$  is bounded on  $[\alpha, \beta]$ , and let  $Q : \alpha = v_0 < v_1 < \cdots < v_L = \beta$  be a fixed partition of  $[\alpha, \beta]$ . Prove:

$$(a) \int_{\alpha}^{\beta} g(u) du = \sum_{\ell=1}^L \int_{v_{\ell-1}}^{v_{\ell}} g(u) du; \quad (b) \int_{\alpha}^{\beta} g(u) du = \sum_{\ell=1}^L \int_{v_{\ell-1}}^{v_{\ell}} g(u) du.$$

7. A function  $f$  is of bounded variation on  $[a, b]$  if there is a number  $K$  such that

$$\sum_{j=1}^n |f(a_j) - f(a_{j-1})| \leq K$$

whenever  $a = a_0 < a_1 < \cdots < a_n = b$ . (The smallest number with this property is the total variation of  $f$  on  $[a, b]$ .)

- (a) Prove: If  $f$  is of bounded variation on  $[a, b]$ , then  $f$  is bounded on  $[a, b]$ .
- (b) Prove: If  $f$  is of bounded variation on  $[a, b]$ , then  $f$  is integrable on  $[a, b]$ .  
HINT: Use Theorems 3.1.4 and 3.2.7.
8. Let  $P = \{x_0, x_1, \dots, x_n\}$  be a partition of  $[a, b]$ ,  $c_0 = x_0 = a$ ,  $c_{n+1} = x_n = b$ , and  $x_{j-1} \leq c_j \leq x_j$ ,  $j = 1, 2, \dots, n$ . Verify that

$$\sum_{j=1}^n g(c_j)[f(x_j) - f(x_{j-1})] = g(b)f(b) - g(a)f(a) - \sum_{j=0}^n f(x_j)[g(c_{j+1}) - g(c_j)].$$

Use this to prove that if  $\int_a^b f(x) dg(x)$  exists, then so does  $\int_a^b g(x) df(x)$ , and

$$\int_a^b g(x) df(x) = f(b)g(b) - f(a)g(a) - \int_a^b f(x) dg(x).$$

(This is the *integration by parts formula* for Riemann–Stieltjes integrals.)

9. Let  $f$  be continuous and  $g$  be of bounded variation (Exercise 3.2.7) on  $[a, b]$ .
- (a) Show that if  $\epsilon > 0$ , there is a  $\delta > 0$  such that  $|\sigma - \sigma'| < \epsilon/2$  if  $\sigma$  and  $\sigma'$  are Riemann–Stieltjes sums of  $f$  with respect to  $g$  over partitions  $P$  and  $P'$  of  $[a, b]$ , where  $P'$  is a refinement of  $P$  and  $\|P\| < \delta$ . HINT: Use Theorem 2.2.12.
- (b) Let  $\delta$  be as chosen in (a). Suppose that  $\sigma_1$  and  $\sigma_2$  are Riemann–Stieltjes sums of  $f$  with respect to  $g$  over any partitions  $P_1$  and  $P_2$  of  $[a, b]$  with norm less than  $\delta$ . Show that  $|\sigma_1 - \sigma_2| < \epsilon$ .
- (c) If  $\delta > 0$ , let  $L(\delta)$  be the supremum of all Riemann–Stieltjes sums of  $f$  with respect to  $g$  over partitions of  $[a, b]$  with norms less than  $\delta$ . Show that  $L(\delta)$  is finite. Then show that  $L = \lim_{\delta \rightarrow 0^+} L(\delta)$  exists. HINT: Use Theorem 2.1.9.
- (d) Show that  $\int_a^b f(x) dg(x) = L$ .
10. Show that  $\int_a^b f(x) dg(x)$  exists if  $f$  is of bounded variation and  $g$  is continuous on  $[a, b]$ . HINT: See Exercises 3.2.8 and 3.2.9.

### 3.3 PROPERTIES OF THE INTEGRAL

We now use the results of Sections 3.1 and 3.2 to establish the properties of the integral. You are probably familiar with most of these properties, but not with their proofs.

**Theorem 3.3.1** *If  $f$  and  $g$  are integrable on  $[a, b]$ , then so is  $f + g$ , and*

$$\int_a^b (f + g)(x) dx = \int_a^b f(x) dx + \int_a^b g(x) dx.$$



**Proof** Any Riemann sum of  $f + g$  over a partition  $P = \{x_0, x_1, \dots, x_n\}$  of  $[a, b]$  can be written as

$$\begin{aligned}\sigma_{f+g} &= \sum_{j=1}^n [f(c_j) + g(c_j)](x_j - x_{j-1}) \\ &= \sum_{j=1}^n f(c_j)(x_j - x_{j-1}) + \sum_{j=1}^n g(c_j)(x_j - x_{j-1}) \\ &= \sigma_f + \sigma_g,\end{aligned}$$

where  $\sigma_f$  and  $\sigma_g$  are Riemann sums for  $f$  and  $g$ . Definition 3.1.1 implies that if  $\epsilon > 0$  there are positive numbers  $\delta_1$  and  $\delta_2$  such that

$$\left| \sigma_f - \int_a^b f(x) dx \right| < \frac{\epsilon}{2} \quad \text{if } \|P\| < \delta_1$$

and

$$\left| \sigma_g - \int_a^b g(x) dx \right| < \frac{\epsilon}{2} \quad \text{if } \|P\| < \delta_2.$$

If  $\|P\| < \delta = \min(\delta_1, \delta_2)$ , then

$$\begin{aligned}\left| \sigma_{f+g} - \int_a^b f(x) dx - \int_a^b g(x) dx \right| &= \left| \left( \sigma_f - \int_a^b f(x) dx \right) + \left( \sigma_g - \int_a^b g(x) dx \right) \right| \\ &\leq \left| \sigma_f - \int_a^b f(x) dx \right| + \left| \sigma_g - \int_a^b g(x) dx \right| \\ &< \frac{\epsilon}{2} + \frac{\epsilon}{2} = \epsilon,\end{aligned}$$

so the conclusion follows from Definition 3.1.1. ■

The next theorem also follows from Definition 3.1.1 (Exercise 3.3.1).

**Theorem 3.3.2** *If  $f$  is integrable on  $[a, b]$  and  $c$  is a constant, then  $cf$  is integrable on  $[a, b]$  and*

$$\int_a^b cf(x) dx = c \int_a^b f(x) dx.$$

Theorems 3.3.1 and 3.3.2 and induction yield the following result (Exercise 3.3.2).

**Theorem 3.3.3** *If  $f_1, f_2, \dots, f_n$  are integrable on  $[a, b]$  and  $c_1, c_2, \dots, c_n$  are constants, then  $c_1f_1 + c_2f_2 + \dots + c_nf_n$  is integrable on  $[a, b]$  and*

$$\begin{aligned}\int_a^b (c_1f_1 + c_2f_2 + \dots + c_nf_n)(x) dx &= c_1 \int_a^b f_1(x) dx + c_2 \int_a^b f_2(x) dx \\ &\quad + \dots + c_n \int_a^b f_n(x) dx.\end{aligned}$$

**Theorem 3.3.4** If  $f$  and  $g$  are integrable on  $[a, b]$  and  $f(x) \leq g(x)$  for  $a \leq x \leq b$ , then

$$\int_a^b f(x) dx \leq \int_a^b g(x) dx. \quad (3.3.1)$$

**Proof** Since  $g(x) - f(x) \geq 0$ , every lower sum of  $g - f$  over any partition of  $[a, b]$  is nonnegative. Therefore,

$$\int_a^b (g(x) - f(x)) dx \geq 0.$$

Hence,

$$\begin{aligned} \int_a^b g(x) dx - \int_a^b f(x) dx &= \int_a^b (g(x) - f(x)) dx \\ &= \int_a^b (g(x) - f(x)) dx \geq 0, \end{aligned} \quad (3.3.2)$$

which yields (3.3.1). (The first equality in (3.3.2) follows from Theorems 3.3.1 and 3.3.2; the second, from Theorem 3.2.3.) ■

**Theorem 3.3.5** If  $f$  is integrable on  $[a, b]$ , then so is  $|f|$ , and

$$\left| \int_a^b f(x) dx \right| \leq \int_a^b |f(x)| dx. \quad (3.3.3)$$

**Proof** Let  $P$  be a partition of  $[a, b]$  and define

$$\begin{aligned} M_j &= \sup \{f(x) \mid x_{j-1} \leq x \leq x_j\}, \\ m_j &= \inf \{f(x) \mid x_{j-1} \leq x \leq x_j\}, \\ \overline{M}_j &= \sup \{|f(x)| \mid x_{j-1} \leq x \leq x_j\}, \\ \overline{m}_j &= \inf \{|f(x)| \mid x_{j-1} \leq x \leq x_j\}. \end{aligned}$$

Then

$$\begin{aligned} \overline{M}_j - \overline{m}_j &= \sup \{|f(x)| - |f(x')| \mid x_{j-1} \leq x, x' \leq x_j\} \\ &\leq \sup \{|f(x) - f(x')| \mid x_{j-1} \leq x, x' \leq x_j\} \\ &= M_j - m_j. \end{aligned} \quad (3.3.4)$$

Therefore,

$$\overline{S}(P) - \overline{s}(P) \leq S(P) - s(P),$$

where the upper and lower sums on the left are associated with  $|f|$  and those on the right are associated with  $f$ . Now suppose that  $\epsilon > 0$ . Since  $f$  is integrable on  $[a, b]$ , Theorem 3.2.7 implies that there is a partition  $P$  of  $[a, b]$  such that  $S(P) - s(P) < \epsilon$ . This inequality and (3.3.4) imply that  $\overline{S}(P) - \overline{s}(P) < \epsilon$ . Therefore,  $|f|$  is integrable on  $[a, b]$ , again by Theorem 3.2.7.

Since

$$f(x) \leq |f(x)| \quad \text{and} \quad -f(x) \leq |f(x)|, \quad a \leq x \leq b,$$

Theorems 3.3.2 and 3.3.4 imply that

$$\int_a^b f(x) dx \leq \int_a^b |f(x)| dx \quad \text{and} \quad -\int_a^b f(x) dx \leq \int_a^b |f(x)| dx,$$

which implies (3.3.3). ■

**Theorem 3.3.6** *If  $f$  and  $g$  are integrable on  $[a, b]$ , then so is the product  $fg$ .*

**Proof** We consider the case where  $f$  and  $g$  are nonnegative, and leave the rest of the proof to you (Exercise 3.3.4). The subscripts  $f$ ,  $g$ , and  $fg$  in the following argument identify the functions with which the various quantities are associated. We assume that neither  $f$  nor  $g$  is identically zero on  $[a, b]$ , since the conclusion is obvious if one of them is.

If  $P = \{x_0, x_1, \dots, x_n\}$  is a partition of  $[a, b]$ , then

$$S_{fg}(P) - s_{fg}(P) = \sum_{j=1}^n (M_{fg,j} - m_{fg,j})(x_j - x_{j-1}). \quad (3.3.5)$$

Since  $f$  and  $g$  are nonnegative,  $M_{fg,j} \leq M_{f,j}M_{g,j}$  and  $m_{fg,j} \geq m_{f,j}m_{g,j}$ . Hence,

$$\begin{aligned} M_{fg,j} - m_{fg,j} &\leq M_{f,j}M_{g,j} - m_{f,j}m_{g,j} \\ &= (M_{f,j} - m_{f,j})M_{g,j} + m_{f,j}(M_{g,j} - m_{g,j}) \\ &\leq M_g(M_{f,j} - m_{f,j}) + M_f(M_{g,j} - m_{g,j}), \end{aligned}$$

where  $M_f$  and  $M_g$  are upper bounds for  $f$  and  $g$  on  $[a, b]$ . From (3.3.5) and the last inequality,

$$S_{fg}(P) - s_{fg}(P) \leq M_g[S_f(P) - s_f(P)] + M_f[S_g(P) - s_g(P)]. \quad (3.3.6)$$

Now suppose that  $\epsilon > 0$ . Theorem 3.2.7 implies that there are partitions  $P_1$  and  $P_2$  of  $[a, b]$  such that

$$S_f(P_1) - s_f(P_1) < \frac{\epsilon}{2M_g} \quad \text{and} \quad S_g(P_2) - s_g(P_2) < \frac{\epsilon}{2M_f}. \quad (3.3.7)$$

If  $P$  is a refinement of both  $P_1$  and  $P_2$ , then (3.3.7) and Lemma 3.2.1 imply that

$$S_f(P) - s_f(P) < \frac{\epsilon}{2M_g} \quad \text{and} \quad S_g(P) - s_g(P) < \frac{\epsilon}{2M_f}.$$

This and (3.3.6) yield

$$S_{fg}(P) - s_{fg}(P) < \frac{\epsilon}{2} + \frac{\epsilon}{2} = \epsilon.$$

Therefore,  $fg$  is integrable on  $[a, b]$ , by Theorem 3.2.7. ■

**Theorem 3.3.7 (First Mean Value Theorem for Integrals)** *Suppose that  $u$  is continuous and  $v$  is integrable and nonnegative on  $[a, b]$ . Then*

$$\int_a^b u(x)v(x) dx = u(c) \int_a^b v(x) dx \quad (3.3.8)$$

for some  $c$  in  $[a, b]$ .

**Proof** From Theorem 3.2.8,  $u$  is integrable on  $[a, b]$ . Therefore, Theorem 3.3.6 implies that the integral on the left exists. If  $m = \min \{u(x) \mid a \leq x \leq b\}$  and  $M = \max \{u(x) \mid a \leq x \leq b\}$  (recall Theorem 2.2.9), then

$$m \leq u(x) \leq M$$

and, since  $v(x) \geq 0$ ,

$$mv(x) \leq u(x)v(x) \leq Mv(x).$$

Therefore, Theorems 3.3.2 and 3.3.4 imply that

$$m \int_a^b v(x) dx \leq \int_a^b u(x)v(x) dx \leq M \int_a^b v(x) dx. \quad (3.3.9)$$

This implies that (3.3.8) holds for any  $c$  in  $[a, b]$  if  $\int_a^b v(x) dx = 0$ . If  $\int_a^b v(x) dx \neq 0$ , let

$$\bar{u} = \frac{\int_a^b u(x)v(x) dx}{\int_a^b v(x) dx} \quad (3.3.10)$$

Since  $\int_a^b v(x) dx > 0$  in this case (why?), (3.3.9) implies that  $m \leq \bar{u} \leq M$ , and the intermediate value theorem (Theorem 2.2.10) implies that  $\bar{u} = u(c)$  for some  $c$  in  $[a, b]$ . This implies (3.3.8). ■

If  $v(x) \equiv 1$ , then (3.3.10) reduces to

$$\bar{u} = \frac{1}{b-a} \int_a^b u(x) dx,$$

so  $\bar{u}$  is the average of  $u(x)$  over  $[a, b]$ . More generally, if  $v$  is any nonnegative integrable function such that  $\int_a^b v(x) dx \neq 0$ , then  $\bar{u}$  in (3.3.10) is the *weighted average of  $u(x)$  over  $[a, b]$  with respect to  $v$* . Theorem 3.3.7 says that a continuous function assumes any such weighted average at some point in  $[a, b]$ .

**Theorem 3.3.8** *If  $f$  is integrable on  $[a, b]$  and  $a \leq a_1 < b_1 \leq b$ , then  $f$  is integrable on  $[a_1, b_1]$ .*

**Proof** Suppose that  $\epsilon > 0$ . From Theorem 3.2.7, there is a partition  $P = \{x_0, x_1, \dots, x_n\}$  of  $[a, b]$  such that

$$S(P) - s(P) = \sum_{j=1}^n (M_j - m_j)(x_j - x_{j-1}) < \epsilon. \quad (3.3.11)$$

We may assume that  $a_1$  and  $b_1$  are partition points of  $P$ , because if not they can be inserted to obtain a refinement  $P'$  such that  $S(P') - s(P') \leq S(P) - s(P)$  (Lemma 3.2.1). Let  $a_1 = x_r$  and  $b_1 = x_s$ . Since every term in (3.3.11) is nonnegative,

$$\sum_{j=r+1}^s (M_j - m_j)(x_j - x_{j-1}) < \epsilon.$$

Thus,  $\bar{P} = \{x_r, x_{r+1}, \dots, x_s\}$  is a partition of  $[a_1, b_1]$  over which the upper and lower sums of  $f$  satisfy

$$S(\bar{P}) - s(\bar{P}) < \epsilon.$$

Therefore,  $f$  is integrable on  $[a_1, b_1]$ , by Theorem 3.2.7. ■

We leave the proof of the next theorem to you (Exercise 3.3.8).

**Theorem 3.3.9** *If  $f$  is integrable on  $[a, b]$  and  $[b, c]$ , then  $f$  is integrable on  $[a, c]$ , and*

$$\int_a^c f(x) dx = \int_a^b f(x) dx + \int_b^c f(x) dx. \quad (3.3.12)$$

So far we have defined  $\int_a^\beta f(x) dx$  only for the case where  $a < \beta$ . Now we define

$$\int_\beta^\alpha f(x) dx = - \int_\alpha^\beta f(x) dx$$

if  $\alpha < \beta$ , and

$$\int_\alpha^\alpha f(x) dx = 0.$$

With these conventions, (3.3.12) holds no matter what the relative order of  $a$ ,  $b$ , and  $c$ , provided that  $f$  is integrable on some closed interval containing them (Exercise 3.3.9).

Theorem 3.3.8 and these definitions enable us to define a function  $F(x) = \int_c^x f(t) dt$ , where  $c$  is an arbitrary, but fixed, point in  $[a, b]$ .

**Theorem 3.3.10** *If  $f$  is integrable on  $[a, b]$  and  $a \leq c \leq b$ , then the function  $F$  defined by*

$$F(x) = \int_c^x f(t) dt$$

*satisfies a Lipschitz condition on  $[a, b]$ , and is therefore continuous on  $[a, b]$ .*

**Proof** If  $x$  and  $x'$  are in  $[a, b]$ , then

$$F(x) - F(x') = \int_c^x f(t) dt - \int_c^{x'} f(t) dt = \int_{x'}^x f(t) dt,$$

by Theorem 3.3.9 and the conventions just adopted. Since  $|f(t)| \leq K$  ( $a \leq t \leq b$ ) for some constant  $K$ ,

$$\left| \int_{x'}^x f(t) dt \right| \leq K|x - x'|, \quad a \leq x, x' \leq b$$

(Theorem 3.3.5), so

$$|F(x) - F(x')| \leq K|x - x'|, \quad a \leq x, x' \leq b.$$

■

**Theorem 3.3.11** *If  $f$  is integrable on  $[a, b]$  and  $a \leq c \leq b$ , then  $F(x) = \int_c^x f(t) dt$  is differentiable at any point  $x_0$  in  $(a, b)$  where  $f$  is continuous, with  $F'(x_0) = f(x_0)$ . If  $f$  is continuous from the right at  $a$ , then  $F'_+(a) = f(a)$ . If  $f$  is continuous from the left at  $b$ , then  $F'_-(b) = f(b)$ .*

**Proof** We consider the case where  $a < x_0 < b$  and leave the rest to you (Exercise 3.3.14). Since

$$\frac{1}{x - x_0} \int_{x_0}^x f(x_0) dt = f(x_0),$$

we can write

$$\frac{F(x) - F(x_0)}{x - x_0} - f(x_0) = \frac{1}{x - x_0} \int_{x_0}^x [f(t) - f(x_0)] dt.$$

From this and Theorem 3.3.5,

$$\left| \frac{F(x) - F(x_0)}{x - x_0} - f(x_0) \right| \leq \frac{1}{|x - x_0|} \left| \int_{x_0}^x |f(t) - f(x_0)| dt \right|. \quad (3.3.13)$$

(Why do we need the absolute value bars outside the integral?) Since  $f$  is continuous at  $x_0$ , there is for each  $\epsilon > 0$  a  $\delta > 0$  such that

$$|f(t) - f(x_0)| < \epsilon \quad \text{if} \quad |x - x_0| < \delta$$

and  $t$  is between  $x$  and  $x_0$ . Therefore, from (3.3.13),

$$\left| \frac{F(x) - F(x_0)}{x - x_0} - f(x_0) \right| < \epsilon \frac{|x - x_0|}{|x - x_0|} = \epsilon \quad \text{if} \quad 0 < |x - x_0| < \delta.$$

Hence,  $F'(x_0) = f(x_0)$ .

■

**Example 3.3.1** If

$$f(x) = \begin{cases} x, & 0 \leq x \leq 1, \\ x + 1, & 1 < x \leq 2, \end{cases}$$

then the function

$$F(x) = \int_0^x f(t) dt = \begin{cases} \frac{x^2}{2}, & 0 < x \leq 1, \\ \frac{x^2}{2} + x - 1, & 1 < x \leq 2, \end{cases}$$

is continuous on  $[0, 2]$ . As implied by Theorem 3.3.11,

$$F'(x) = \begin{cases} x = f(x), & 0 < x < 1, \\ x + 1 = f(x), & 1 < x < 2, \end{cases}$$

$$F'_+(0) = \lim_{x \rightarrow 0^+} \frac{F(x) - F(0)}{x} = \lim_{x \rightarrow 0^+} \frac{(x^2/2) - 0}{x} = 0 = f(0),$$

$$F'_-(2) = \lim_{x \rightarrow 2^-} \frac{F(x) - F(2)}{x - 2} = \lim_{x \rightarrow 2^-} \frac{(x^2/2) + x - 1 - 3}{x - 2}$$

$$= \lim_{x \rightarrow 2^-} \frac{x + 4}{2} = 3 = f(2).$$

$F$  does not have a derivative at  $x = 1$ , where  $f$  is discontinuous, since

$$F'_-(1) = 1 \quad \text{and} \quad F'_+(1) = 2. \quad \blacksquare$$

The next theorem relates integration and differentiation in another way.

**Theorem 3.3.12** Suppose that  $F$  is continuous on the closed interval  $[a, b]$  and differentiable on the open interval  $(a, b)$ , and  $f$  is integrable on  $[a, b]$ . Suppose also that

$$F'(x) = f(x), \quad a < x < b.$$

Then

$$\int_a^b f(x) dx = F(b) - F(a). \quad (3.3.14)$$

**Proof** If  $P = \{x_0, x_1, \dots, x_n\}$  is a partition of  $[a, b]$ , then

$$F(b) - F(a) = \sum_{j=1}^n (F(x_j) - F(x_{j-1})). \quad (3.3.15)$$

From Theorem 2.3.11, there is in each open interval  $(x_{j-1}, x_j)$  a point  $c_j$  such that

$$F(x_j) - F(x_{j-1}) = f(c_j)(x_j - x_{j-1}).$$

Hence, (3.3.15) can be written as

$$F(b) - F(a) = \sum_{j=1}^n f(c_j)(x_j - x_{j-1}) = \sigma,$$

where  $\sigma$  is a Riemann sum for  $f$  over  $P$ . Since  $f$  is integrable on  $[a, b]$ , there is for each  $\epsilon > 0$  a  $\delta > 0$  such that

$$\left| \sigma - \int_a^b f(x) dx \right| < \epsilon \quad \text{if} \quad \|P\| < \delta.$$

Therefore,

$$\left| F(b) - F(a) - \int_a^b f(x) dx \right| < \epsilon$$

for every  $\epsilon > 0$ , which implies (3.3.14). ■

**Corollary 3.3.13** *If  $f'$  is integrable on  $[a, b]$ , then*

$$\int_a^b f'(x) dx = f(b) - f(a).$$

**Proof** Apply Theorem 3.3.12 with  $F$  and  $f$  replaced by  $f$  and  $f'$ , respectively. ■

A function  $F$  is an *antiderivative* of  $f$  on  $[a, b]$  if  $F$  is continuous on  $[a, b]$  and differentiable on  $(a, b)$ , with

$$F'(x) = f(x), \quad a < x < b.$$

If  $F$  is an antiderivative of  $f$  on  $[a, b]$ , then so is  $F + c$  for any constant  $c$ . Conversely, if  $F_1$  and  $F_2$  are antiderivatives of  $f$  on  $[a, b]$ , then  $F_1 - F_2$  is constant on  $[a, b]$  (Theorem 2.3.12). Theorem 3.3.12 shows that antiderivatives can be used to evaluate integrals.

**Theorem 3.3.14 (Fundamental Theorem of Calculus)** *If  $f$  is continuous on  $[a, b]$ , then  $f$  has an antiderivative on  $[a, b]$ . Moreover, if  $F$  is any antiderivative of  $f$  on  $[a, b]$ , then*

$$\int_a^b f(x) dx = F(b) - F(a).$$

**Proof** The function  $F_0(x) = \int_a^x f(t) dt$  is continuous on  $[a, b]$  by Theorem 3.3.10, and  $F_0'(x) = f(x)$  on  $(a, b)$  by Theorem 3.3.11. Therefore,  $F_0$  is an antiderivative of  $f$  on  $[a, b]$ . Now let  $F = F_0 + c$  ( $c = \text{constant}$ ) be an arbitrary antiderivative of  $f$  on  $[a, b]$ . Then

$$F(b) - F(a) = \int_a^b f(x) dx + c - \int_a^a f(x) dx - c = \int_a^b f(x) dx. \quad \blacksquare$$



When applying this theorem, we will use the familiar notation

$$F(b) - F(a) = F(x) \Big|_a^b.$$

**Theorem 3.3.15 (Integration by Parts)** *If  $u'$  and  $v'$  are integrable on  $[a, b]$ , then*

$$\int_a^b u(x)v'(x) dx = u(x)v(x) \Big|_a^b - \int_a^b v(x)u'(x) dx. \quad (3.3.16)$$

**Proof** Since  $u$  and  $v$  are continuous on  $[a, b]$  (Theorem 2.3.3), they are integrable on  $[a, b]$ . Therefore, Theorems 3.3.1 and 3.3.6 imply that the function

$$(uv)' = u'v + uv'$$

is integrable on  $[a, b]$ , and Theorem 3.3.12 implies that

$$\int_a^b [u(x)v'(x) + u'(x)v(x)] dx = u(x)v(x) \Big|_a^b,$$

which implies (3.3.16). ■

We will use Theorem 3.3.15 here and in the next section to obtain other results.

**Theorem 3.3.16 (Second Mean Value Theorem for Integrals)** *Suppose that  $f'$  is nonnegative and integrable and  $g$  is continuous on  $[a, b]$ . Then*

$$\int_a^b f(x)g(x) dx = f(a) \int_a^c g(x) dx + f(b) \int_c^b g(x) dx \quad (3.3.17)$$

for some  $c$  in  $[a, b]$ .

**Proof** Since  $f$  is differentiable on  $[a, b]$ , it is continuous on  $[a, b]$  (Theorem 2.3.3). Since  $g$  is continuous on  $[a, b]$ , so is  $fg$  (Theorem 2.2.5). Therefore, Theorem 3.2.8 implies that the integrals in (3.3.17) exist. If

$$G(x) = \int_a^x g(t) dt, \quad (3.3.18)$$

then  $G'(x) = g(x)$ ,  $a < x < b$  (Theorem 3.3.11). Therefore, Theorem 3.3.15 with  $u = f$  and  $v = G$  yields

$$\int_a^b f(x)g(x) dx = f(x)G(x) \Big|_a^b - \int_a^b f'(x)G(x) dx. \quad (3.3.19)$$

Since  $f'$  is nonnegative and  $G$  is continuous, Theorem 3.3.7 implies that

$$\int_a^b f'(x)G(x) dx = G(c) \int_a^b f'(x) dx \quad (3.3.20)$$

for some  $c$  in  $[a, b]$ . From Corollary 3.3.12,

$$\int_a^b f'(x) dx = f(b) - f(a).$$

From this and (3.3.18), (3.3.20) can be rewritten as

$$\int_a^b f'(x)G(x) dx = (f(b) - f(a)) \int_a^c g(x) dx.$$

Substituting this into (3.3.19) and noting that  $G(a) = 0$  yields

$$\begin{aligned} \int_a^b f(x)g(x) dx &= f(b) \int_a^b g(x) dx - (f(b) - f(a)) \int_a^c g(x) dx, \\ &= f(a) \int_a^c g(x) dx + f(b) \left( \int_a^b g(x) dx - \int_c^a g(x) dx \right) \\ &= f(a) \int_a^c g(x) dx + f(b) \int_c^b g(x) dx. \end{aligned}$$

■

## Change of Variable

The following theorem on change of variable is useful for evaluating integrals.

**Theorem 3.3.17** Suppose that the transformation  $x = \phi(t)$  maps the interval  $c \leq t \leq d$  into the interval  $a \leq x \leq b$ , with  $\phi(c) = \alpha$  and  $\phi(d) = \beta$ , and let  $f$  be continuous on  $[a, b]$ . Let  $\phi'$  be integrable on  $[c, d]$ . Then

$$\int_a^b f(x) dx = \int_c^d f(\phi(t))\phi'(t) dt. \quad (3.3.21)$$

**Proof** Both integrals in (3.3.21) exist: the one on the left by Theorem 3.2.8, the one on the right by Theorems 3.2.8 and 3.3.6 and the continuity of  $f(\phi(t))$ . By Theorem 3.3.11, the function

$$F(x) = \int_a^x f(y) dy$$

is an antiderivative of  $f$  on  $[a, b]$  and, therefore, also on the closed interval with endpoints  $\alpha$  and  $\beta$ . Hence, by Theorem 3.3.14,

$$\int_a^b f(x) dx = F(\beta) - F(\alpha). \quad (3.3.22)$$

By the chain rule, the function

$$G(t) = F(\phi(t))$$

is an antiderivative of  $f(\phi(t))\phi'(t)$  on  $[c, d]$ , and Theorem 3.3.12 implies that

$$\begin{aligned}\int_c^d f(\phi(t))\phi'(t) dt &= G(d) - G(c) = F(\phi(d)) - F(\phi(c)) \\ &= F(\beta) - F(\alpha).\end{aligned}$$

Comparing this with (3.3.22) yields (3.3.21). ■

**Example 3.3.2** To evaluate the integral

$$I = \int_{-1/\sqrt{2}}^{1/\sqrt{2}} (1 - 2x^2)(1 - x^2)^{-1/2} dx$$

we let

$$f(x) = (1 - 2x^2)(1 - x^2)^{-1/2}, \quad -1/\sqrt{2} \leq x \leq 1/\sqrt{2},$$

and

$$x = \phi(t) = \sin t, \quad -\pi/4 \leq t \leq \pi/4.$$

Then  $\phi'(t) = \cos t$  and

$$\begin{aligned}I &= \int_{-1/\sqrt{2}}^{1/\sqrt{2}} f(x) dx = \int_{-\pi/4}^{\pi/4} f(\sin t) \cos t dt \\ &= \int_{-\pi/4}^{\pi/4} (1 - 2\sin^2 t)(1 - \sin^2 t)^{-1/2} \cos t dt.\end{aligned}\tag{3.3.23}$$

$$(1 - \sin^2 t)^{1/2} = \cos t, \quad -\pi/4 \leq t \leq \pi/4$$

and

$$1 - 2\sin^2 t = \cos 2t,$$

(3.3.23) yields

$$I = \int_{-\pi/4}^{\pi/4} \cos 2t dt = \left. \frac{\sin 2t}{2} \right|_{-\pi/4}^{\pi/4} = 1.$$

**Example 3.3.3** To evaluate the integral

$$I = \int_0^{5\pi} \frac{\sin t}{2 + \cos t} dt,$$

we take  $\phi(t) = \cos t$ . Then  $\phi'(t) = -\sin t$  and

$$I = - \int_0^{5\pi} \frac{\phi'(t)}{2 + \phi(t)} dt = - \int_0^{5\pi} f(\phi(t))\phi'(t) dt,$$

where

$$f(x) = \frac{1}{2 + x}.$$

Therefore, since  $\phi(0) = 1$  and  $\phi(5\pi) = -1$ ,

$$I = - \int_1^{-1} \frac{dx}{2+x} = - \log(2+x) \Big|_1^{-1} = \log 3. \quad \blacksquare$$

These examples illustrate two ways to use Theorem 3.3.17. In Example 3.3.2 we evaluated the left side of (3.3.21) by transforming it to the right side with a suitable substitution  $x = \phi(t)$ , while in Example 3.3.3 we evaluated the right side of (3.3.21) by recognizing that it could be obtained from the left side by a suitable substitution.

The following theorem shows that the rule for change of variable remains valid under weaker assumptions on  $f$  if  $\phi$  is monotonic.

**Theorem 3.3.18** *Suppose that  $\phi'$  is integrable and  $\phi$  is monotonic on  $[c, d]$ , and the transformation  $x = \phi(t)$  maps  $[c, d]$  onto  $[a, b]$ . Let  $f$  be bounded on  $[a, b]$ . Then*

$$g(t) = f(\phi(t))\phi'(t)$$

*is integrable on  $[c, d]$  if and only if  $f$  is integrable over  $[a, b]$ , and in this case*

$$\int_a^b f(x) dx = \int_c^d f(\phi(t))|\phi'(t)| dt.$$

**Proof** We consider the case where  $f$  is nonnegative and  $\phi$  is nondecreasing, and leave the rest of the proof to you (Exercises 3.3.20 and 3.3.21).

First assume that  $\phi$  is increasing. We show first that

$$\overline{\int_a^b} f(x) dx = \overline{\int_c^d} f(\phi(t))\phi'(t) dt. \quad (3.3.24)$$

Let  $\overline{P} = \{t_0, t_1, \dots, t_n\}$  be a partition of  $[c, d]$  and  $P = \{x_0, x_1, \dots, x_n\}$  with  $x_j = \phi(t_j)$  be the corresponding partition of  $[a, b]$ . Define

$$\begin{aligned} U_j &= \sup \{ \phi'(t) \mid t_{j-1} \leq t \leq t_j \}, \\ u_j &= \inf \{ \phi'(t) \mid t_{j-1} \leq t \leq t_j \}, \\ M_j &= \sup \{ f(x) \mid x_{j-1} \leq x \leq x_j \}, \end{aligned}$$

and

$$\overline{M}_j = \sup \{ f(\phi(t))\phi'(t) \mid t_{j-1} \leq t \leq t_j \}.$$

Since  $\phi$  is increasing,  $u_j \geq 0$ . Therefore,

$$0 \leq u_j \leq \phi'(t) \leq U_j, \quad t_{j-1} \leq t \leq t_j.$$

Since  $f$  is nonnegative, this implies that

$$0 \leq f(\phi(t))u_j \leq f(\phi(t))\phi'(t) \leq f(\phi(t))U_j, \quad t_{j-1} \leq t \leq t_j.$$

Therefore,

$$M_j u_j \leq \overline{M}_j \leq M_j U_j,$$

which implies that

$$\overline{M}_j = M_j \rho_j, \quad (3.3.25)$$

where

$$u_j \leq \rho_j \leq U_j. \quad (3.3.26)$$

Now consider the upper sums

$$\overline{S}(\overline{P}) = \sum_{j=1}^n \overline{M}_j (t_j - t_{j-1}) \quad \text{and} \quad S(P) = \sum_{j=1}^n M_j (x_j - x_{j-1}). \quad (3.3.27)$$

From the mean value theorem,

$$x_j - x_{j-1} = \phi(t_j) - \phi(t_{j-1}) = \phi'(\tau_j)(t_j - t_{j-1}), \quad (3.3.28)$$

where  $t_{j-1} < \tau_j < t_j$ , so

$$u_j \leq \phi'(\tau_j) \leq U_j. \quad (3.3.29)$$

From (3.3.25), (3.3.27), and (3.3.28),

$$\overline{S}(\overline{P}) - S(P) = \sum_{j=1}^n M_j (\rho_j - \phi'(\tau_j))(t_j - t_{j-1}). \quad (3.3.30)$$

Now suppose that  $|f(x)| \leq M$ ,  $a \leq x \leq b$ . Then (3.3.26), (3.3.29), and (3.3.30) imply that

$$|\overline{S}(\overline{P}) - S(P)| \leq M \sum_{j=1}^n (U_j - u_j)(t_j - t_{j-1}).$$

The sum on the right is the difference between the upper and lower sums of  $\phi'$  over  $\overline{P}$ . Since  $\phi'$  is integrable on  $[c, d]$ , this can be made as small as we please by choosing  $\|\overline{P}\|$  sufficiently small (Exercise 3.2.4).

From (3.3.28),  $\|P\| \leq K\|\overline{P}\|$  if  $|\phi'(t)| \leq K$ ,  $c \leq t \leq d$ . Hence, Lemma 3.2.4 implies that

$$\left| S(P) - \int_a^b f(x) dx \right| < \frac{\epsilon}{3} \quad \text{and} \quad \left| \overline{S}(\overline{P}) - \int_c^d f(\phi(t))\phi'(t) dt \right| < \frac{\epsilon}{3} \quad (3.3.31)$$

if  $\|\overline{P}\|$  is sufficiently small. Now

$$\begin{aligned} \left| \int_a^b f(x) dx - \int_c^d f(\phi(t))\phi'(t) dt \right| &\leq \left| \int_a^b f(x) dx - S(P) \right| + |S(P) - \overline{S}(\overline{P})| \\ &\quad + \left| \overline{S}(\overline{P}) - \int_c^d f(\phi(t))\phi'(t) dt \right|. \end{aligned}$$

Choosing  $\overline{P}$  so that  $|S(P) - \overline{S}(\overline{P})| < \epsilon/3$  in addition to (3.3.31) yields

$$\left| \int_a^b f(x) dx - \int_c^d f(\phi(t))\phi'(t) dt \right| < \epsilon.$$

Since  $\epsilon$  is an arbitrary positive number, this implies (3.3.24).

If  $\phi$  is nondecreasing (rather than increasing), it may happen that  $x_{j-1} = x_j$  for some values of  $j$ ; however, this is no real complication, since it simply means that some terms in  $S(P)$  vanish.

By applying (3.3.24) to  $-f$ , we infer that

$$\int_a^b f(x) dx = \int_c^d f(\phi(t))\phi'(t) dt, \quad (3.3.32)$$

since

$$\int_a^b (-f)(x) dx = -\int_a^b f(x) dx$$

and

$$\int_c^d (-f(\phi(t))\phi'(t)) dt = -\int_c^d f(\phi(t))\phi'(t) dt.$$

Now suppose that  $f$  is integrable on  $[a, b]$ . Then

$$\int_a^b f(x) dx = \overline{\int_a^b f(x) dx} = \int_a^b f(x) dx,$$

by Theorem 3.2.3. From this, (3.3.24), and (3.3.32),

$$\int_c^d f(\phi(t))\phi'(t) dt = \overline{\int_c^d f(\phi(t))\phi'(t) dt} = \int_a^b f(x) dx.$$

This and Theorem 3.2.5 (applied to  $f(\phi(t))\phi'(t)$ ) imply that  $f(\phi(t))\phi'(t)$  is integrable on  $[c, d]$  and

$$\int_a^b f(x) dx = \int_c^d f(\phi(t))\phi'(t) dt. \quad (3.3.33)$$

A similar argument shows that if  $f(\phi(t))\phi'(t)$  is integrable on  $[c, d]$ , then  $f$  is integrable on  $[a, b]$ , and (3.3.33) holds. ■

### 3.3 Exercises

1. Prove Theorem 3.3.2.
2. Prove Theorem 3.3.3.
3. Can  $|f|$  be integrable on  $[a, b]$  if  $f$  is not?
4. Complete the proof of Theorem 3.3.6. HINT: *The partial proof given above implies that if  $m_1$  and  $m_2$  are lower bounds for  $f$  and  $g$  respectively on  $[a, b]$ , then  $(f - m_1)(g - m_2)$  is integrable on  $[a, b]$ .*
5. Prove: If  $f$  is integrable on  $[a, b]$  and  $|f(x)| \geq \rho > 0$  for  $a \leq x \leq b$ , then  $1/f$  is integrable on  $[a, b]$

6. Suppose that  $f$  is integrable on  $[a, b]$  and define

$$f^+(x) = \begin{cases} f(x) & \text{if } f(x) \geq 0, \\ 0 & \text{if } f(x) < 0, \end{cases} \quad \text{and} \quad f^-(x) = \begin{cases} 0 & \text{if } f(x) \geq 0, \\ f(x) & \text{if } f(x) < 0. \end{cases}$$

Show that  $f^+$  and  $f^-$  are integrable on  $[a, b]$ , and

$$\int_a^b f(x) dx = \int_a^b f^+(x) dx + \int_a^b f^-(x) dx.$$

7. Find the weighted average  $\bar{u}$  of  $u(x)$  over  $[a, b]$  with respect to  $v$ , and find a point  $c$  in  $[a, b]$  such that  $u(c) = \bar{u}$ .

(a)  $u(x) = x, \quad v(x) = x, \quad [a, b] = [0, 1]$

(b)  $u(x) = \sin x, \quad v(x) = x^2, \quad [a, b] = [-1, 1]$

(c)  $u(x) = x^2, \quad v(x) = e^x, \quad [a, b] = [0, 1]$

8. Prove Theorem 3.3.9.

9. Show that

$$\int_a^c f(x) dx = \int_a^b f(x) dx + \int_b^c f(x) dx$$

for all possible relative orderings of  $a, b$ , and  $c$ , provided that  $f$  is integrable on a closed interval containing them.

10. Prove: If  $f$  is integrable on  $[a, b]$  and  $a = a_0 < a_1 < \dots < a_n = b$ , then

$$\int_a^b f(x) dx = \int_{a_0}^{a_1} f(x) dx + \int_{a_1}^{a_2} f(x) dx + \dots + \int_{a_{n-1}}^{a_n} f(x) dx.$$

11. Suppose that  $f$  is continuous on  $[a, b]$  and  $P = \{x_0, x_1, \dots, x_n\}$  is a partition of  $[a, b]$ . Show that there is a Riemann sum of  $f$  over  $P$  that equals  $\int_a^b f(x) dx$ .
12. Suppose that  $f'$  exists and  $|f'(x)| \leq M$  on  $[a, b]$ . Show that any Riemann sum  $\sigma$  of  $f$  over any partition  $P$  of  $[a, b]$  satisfies

$$\left| \sigma - \int_a^b f(x) dx \right| \leq M(b-a)\|P\|.$$

HINT: See Exercise 3.3.11.

13. Prove: If  $f$  is integrable and  $f(x) \geq 0$  on  $[a, b]$ , then  $\int_a^b f(x) dx \geq 0$ , with strict inequality if  $f$  is continuous and positive at some point in  $[a, b]$ .
14. Complete the proof of Theorem 3.3.11.
15. State theorems analogous to Theorems 3.3.10 and 3.3.11 for the function

$$G(x) = \int_x^c f(t) dt,$$

and show how your theorems can be obtained from them.

16. The symbol  $\int f(x) dx$  denotes an antiderivative of  $f$ . A plausible analog of Theorem 3.3.1 would state that if  $f$  and  $g$  have antiderivatives on  $[a, b]$ , then so does  $f + g$ , which is true, and

$$\int (f + g)(x) dx = \int f(x) dx + \int g(x) dx. \quad (\text{A})$$

However, this is not true in the usual sense.

- (a) Why not?  
 (b) State a correct interpretation of (A).
17. (See Exercise 3.3.16.) Formulate a valid interpretation of the relation

$$\int (cf)(x) dx = c \int f(x) dx \quad (c \neq 0).$$

Is your interpretation valid if  $c = 0$ ?

18. (a) Let  $f^{(n+1)}$  be integrable on  $[a, b]$ . Show that

$$f(b) = \sum_{r=0}^n \frac{f^{(r)}(a)}{r!} (b-a)^r + \frac{1}{n!} \int_a^b f^{(n+1)}(t) (b-t)^n dt.$$

HINT: *Integrate by parts and use induction.*

- (b) What is the connection between (a) and Theorem 2.5.5?
19. In addition to the assumptions of Theorem 3.3.16, suppose that  $f(a) = 0$ ,  $f \neq 0$ , and  $g(x) > 0$  ( $a < x < b$ ). Show that there is only one point  $c$  in  $[a, b]$  with the property stated in Theorem 3.3.16. HINT: *Use Exercise 3.3.13.*
20. Assuming that Theorem 3.3.18 is true under the additional assumption that  $f$  is nonnegative on  $[a, b]$ , show that it is true without this assumption.
21. Assuming that the conclusion of Theorem 3.3.18 is true if  $\phi$  is nondecreasing, show that it is true if  $\phi$  is nonincreasing. HINT: *Use Exercise 3.1.6.*
22. Suppose  $g'$  is integrable and  $f$  is continuous on  $[a, b]$ . Show that  $\int_a^b f(x) dg(x)$  exists and equals  $\int_a^b f(x)g'(x) dx$ .
23. Suppose  $f$  and  $g''$  are bounded and  $fg'$  is integrable on  $[a, b]$ . Show that  $\int_a^b f(x) dg(x)$  exists and equals  $\int_a^b f(x)g'(x) dx$ . HINT: *Use Theorem 2.5.4.*

### 3.4 IMPROPER INTEGRALS

So far we have confined our study of the integral to bounded functions on finite closed intervals. This was for good reasons:

- From Theorem 3.1.2, an unbounded function cannot be integrable on a finite closed interval.



- Attempting to formulate Definition 3.1.1 for a function defined on an infinite or semi-infinite interval would introduce questions concerning convergence of the resulting Riemann sums, which would be infinite series.

In this section we extend the definition of integral to include cases where  $f$  is unbounded or the interval is unbounded, or both.

We say  $f$  is *locally integrable* on an interval  $I$  if  $f$  is integrable on every finite closed subinterval of  $I$ . For example,

$$f(x) = \sin x$$

is locally integrable on  $(-\infty, \infty)$ ;

$$g(x) = \frac{1}{x(x-1)}$$

is locally integrable on  $(-\infty, 0)$ ,  $(0, 1)$ , and  $(1, \infty)$ ; and

$$h(x) = \sqrt{x}$$

is locally integrable on  $[0, \infty)$ .

**Definition 3.4.1** If  $f$  is locally integrable on  $[a, b)$ , we define

$$\int_a^b f(x) dx = \lim_{c \rightarrow b^-} \int_a^c f(x) dx \quad (3.4.1)$$

if the limit exists (finite). To include the case where  $b = \infty$ , we adopt the convention that  $\infty^- = \infty$ . ■

The limit in (3.4.1) always exists if  $[a, b)$  is finite and  $f$  is locally integrable and bounded on  $[a, b)$ . In this case, Definitions 3.1.1 and 3.4.1 assign the same value to  $\int_a^b f(x) dx$  no matter how  $f(b)$  is defined (Exercise 3.4.1). However, the limit may also exist in cases where  $b = \infty$  or  $b < \infty$  and  $f$  is unbounded as  $x$  approaches  $b$  from the left. In these cases, Definition 3.4.1 assigns a value to an integral that does not exist in the sense of Definition 3.1.1, and  $\int_a^b f(x) dx$  is said to be an *improper integral* that *converges* to the limit in (3.4.1). We also say in this case that  $f$  is *integrable on  $[a, b)$*  and that  $\int_a^b f(x) dx$  *exists*. If the limit in (3.4.1) does not exist (finite), we say that the improper integral  $\int_a^b f(x) dx$  *diverges*, and  $f$  is *nonintegrable on  $[a, b)$* . In particular, if  $\lim_{c \rightarrow b^-} \int_a^c f(x) dx = \pm\infty$ , we say that  $\int_a^b f(x) dx$  *diverges to  $\pm\infty$* , and we write

$$\int_a^b f(x) dx = \infty \quad \text{or} \quad \int_a^b f(x) dx = -\infty,$$

whichever the case may be.

Similar comments apply to the next two definitions.

**Definition 3.4.2** If  $f$  is locally integrable on  $(a, b]$ , we define

$$\int_a^b f(x) dx = \lim_{c \rightarrow a^+} \int_c^b f(x) dx$$

provided that the limit exists (finite). To include the case where  $a = -\infty$ , we adopt the convention that  $-\infty + = -\infty$ .

**Definition 3.4.3** If  $f$  is locally integrable on  $(a, b)$ , we define

$$\int_a^b f(x) dx = \int_a^\alpha f(x) dx + \int_\alpha^b f(x) dx,$$

where  $a < \alpha < b$ , provided that both improper integrals on the right exist (finite). ■

The existence and value of  $\int_a^b f(x) dx$  according to Definition 3.4.3 do not depend on the particular choice of  $\alpha$  in  $(a, b)$  (Exercise 3.4.2).

When we wish to distinguish between improper integrals and integrals in the sense of Definition 3.1.1, we will call the latter *proper integrals*.

In stating and proving theorems on improper integrals, we will consider integrals of the kind introduced in Definition 3.4.1. Similar results apply to the integrals of Definitions 3.4.2 and 3.4.3. We leave it to you to formulate and use them in the examples and exercises as the need arises.

**Example 3.4.1** The function

$$f(x) = 2x \sin \frac{1}{x} - \cos \frac{1}{x}$$

is locally integrable and the derivative of

$$F(x) = x^2 \sin \frac{1}{x}$$

on  $[-2/\pi, 0)$ . Hence,

$$\int_{-2/\pi}^c f(x) dx = x^2 \sin \frac{1}{x} \Big|_{-2/\pi}^c = c^2 \sin \frac{1}{c} + \frac{4}{\pi^2}$$

and

$$\int_{-2/\pi}^0 f(x) dx = \lim_{c \rightarrow 0^-} \left( c^2 \sin \frac{1}{c} + \frac{4}{\pi^2} \right) = \frac{4}{\pi^2},$$

according to Definition 3.4.1. However, this is not an improper integral, even though  $f(0)$  is not defined and cannot be defined so as to make  $f$  continuous at 0. If we define  $f(0)$  arbitrarily (say  $f(0) = 10$ ), then  $f$  is bounded on the closed interval  $[-2/\pi, 0]$  and continuous except at 0. Therefore,  $\int_{-2/\pi}^0 f(x) dx$  exists and equals  $4/\pi^2$  as a proper integral (Exercise 3.4.1), in the sense of Definition 3.1.1.

**Example 3.4.2** The function

$$f(x) = (1-x)^{-p}$$

is locally integrable on  $[0, 1)$  and, if  $p \neq 1$  and  $0 < c < 1$ ,

$$\int_0^c (1-x)^{-p} dx = \frac{(1-x)^{-p+1}}{p-1} \Big|_0^c = \frac{(1-c)^{-p+1} - 1}{p-1}.$$

Hence,

$$\lim_{c \rightarrow 1^-} \int_0^c (1-x)^{-p} dx = \begin{cases} (1-p)^{-1}, & p < 1, \\ \infty, & p > 1. \end{cases}$$

For  $p = 1$ ,

$$\lim_{c \rightarrow 1^-} \int_0^c (1-x)^{-1} dx = -\lim_{c \rightarrow 1^-} \log(1-c) = \infty.$$

Hence,

$$\int_0^1 (1-x)^{-p} dx = \begin{cases} (1-p)^{-1}, & p < 1, \\ \infty, & p \geq 1. \end{cases}$$

**Example 3.4.3** The function

$$f(x) = x^{-p}$$

is locally integrable on  $[1, \infty)$  and, if  $p \neq 1$  and  $c > 1$ ,

$$\int_1^c x^{-p} dx = \frac{x^{-p+1}}{-p+1} \Big|_1^c = \frac{c^{-p+1} - 1}{-p+1}.$$

Hence,

$$\lim_{c \rightarrow \infty} \int_1^c x^{-p} dx = \begin{cases} (p-1)^{-1}, & p > 1, \\ \infty, & p < 1. \end{cases}$$

For  $p = 1$ ,

$$\lim_{c \rightarrow \infty} \int_1^c x^{-1} dx = \lim_{c \rightarrow \infty} \log c = \infty.$$

Hence,

$$\int_1^\infty x^{-p} dx = \begin{cases} (p-1)^{-1}, & p > 1, \\ \infty, & p \leq 1. \end{cases}$$

**Example 3.4.4** If  $1 < c < \infty$ , then

$$\int_1^c \frac{1}{x} \log \frac{1}{x} dx = -\int_1^c \frac{1}{x} \log x dx = -\frac{1}{2}(\log x)^2 \Big|_1^c = -\frac{1}{2}(\log c)^2.$$

Hence,

$$\lim_{c \rightarrow \infty} \int_1^c \frac{1}{x} \log \frac{1}{x} dx = -\infty,$$

so

$$\int_1^\infty \frac{1}{x} \log \frac{1}{x} dx = -\infty.$$

**Example 3.4.5** The function  $f(x) = \cos x$  is locally integrable on  $[0, \infty)$  and

$$\lim_{c \rightarrow \infty} \int_0^c \cos x \, dx = \lim_{c \rightarrow \infty} \sin c$$

does not exist; thus,  $\int_0^\infty \cos x \, dx$  diverges, but not to  $\pm\infty$ .

**Example 3.4.6** The function  $f(x) = \log x$  is locally integrable on  $(0, 1]$ , but unbounded as  $x \rightarrow 0+$ . Since

$$\lim_{c \rightarrow 0+} \int_c^1 \log x \, dx = \lim_{c \rightarrow 0+} (x \log x - x) \Big|_c^1 = -1 - \lim_{c \rightarrow 0+} (c \log c - c) = -1,$$

Definition 3.4.2 yields

$$\int_0^1 \log x \, dx = -1.$$

**Example 3.4.7** In connection with Definition 3.4.3, it is important to recognize that the improper integrals  $\int_a^\alpha f(x) \, dx$  and  $\int_\alpha^b f(x) \, dx$  must converge *separately* for  $\int_a^b f(x) \, dx$  to converge. For example, the existence of the symmetric limit

$$\lim_{R \rightarrow \infty} \int_{-R}^R f(x) \, dx,$$

which is called the *principal value* of  $\int_{-\infty}^\infty f(x) \, dx$ , does not imply that  $\int_{-\infty}^\infty f(x) \, dx$  converges; thus,

$$\lim_{R \rightarrow \infty} \int_{-R}^R x \, dx = \lim_{R \rightarrow \infty} 0 = 0,$$

but  $\int_0^\infty x \, dx$  and  $\int_{-\infty}^0 x \, dx$  diverge and therefore so does  $\int_{-\infty}^\infty x \, dx$ .

**Theorem 3.4.4** Suppose that  $f_1, f_2, \dots, f_n$  are locally integrable on  $[a, b)$  and that  $\int_a^b f_1(x) \, dx, \int_a^b f_2(x) \, dx, \dots, \int_a^b f_n(x) \, dx$  converge. Let  $c_1, c_2, \dots, c_n$  be constants. Then  $\int_a^b (c_1 f_1 + c_2 f_2 + \dots + c_n f_n)(x) \, dx$  converges and

$$\begin{aligned} \int_a^b (c_1 f_1 + c_2 f_2 + \dots + c_n f_n)(x) \, dx &= c_1 \int_a^b f_1(x) \, dx + c_2 \int_a^b f_2(x) \, dx \\ &\quad + \dots + c_n \int_a^b f_n(x) \, dx. \end{aligned}$$

**Proof** If  $a < c < b$ , then

$$\begin{aligned} \int_a^c (c_1 f_1 + c_2 f_2 + \dots + c_n f_n)(x) \, dx &= c_1 \int_a^c f_1(x) \, dx + c_2 \int_a^c f_2(x) \, dx \\ &\quad + \dots + c_n \int_a^c f_n(x) \, dx, \end{aligned}$$

by Theorem 3.3.3. Letting  $c \rightarrow b-$  yields the stated result. ■

### Improper Integrals of Nonnegative Functions

The theory of improper integrals of nonnegative functions is particularly simple.

**Theorem 3.4.5** *If  $f$  is nonnegative and locally integrable on  $[a, b)$ , then  $\int_a^b f(x) dx$  converges if the function*

$$F(x) = \int_a^x f(t) dt$$

*is bounded on  $[a, b)$ , and  $\int_a^b f(x) dx = \infty$  if it is not. These are the only possibilities, and*

$$\int_a^b f(t) dt = \sup_{a \leq x < b} F(x)$$

*in either case.*

**Proof** Since  $F$  is nondecreasing on  $[a, b)$ , Theorem 2.1.9(a) implies the conclusion. ■

We often write

$$\int_a^b f(x) dx < \infty$$

to indicate that an improper integral of a nonnegative function converges. Theorem 3.4.5 justifies this convention, since it asserts that a divergent integral of this kind can only diverge to  $\infty$ . Similarly, if  $f$  is nonpositive and  $\int_a^b f(x) dx$  converges, we write

$$\int_a^b f(x) dx > -\infty$$

because a divergent integral of this kind can only diverge to  $-\infty$ . (To see this, apply Theorem 3.4.5 to  $-f$ .) These conventions do not apply to improper integrals of functions that assume both positive and negative values in  $(a, b)$ , since they may diverge without diverging to  $\pm\infty$ .

**Theorem 3.4.6 (Comparison Test)** *If  $f$  and  $g$  are locally integrable on  $[a, b)$  and*

$$0 \leq f(x) \leq g(x), \quad a \leq x < b, \quad (3.4.2)$$

*then*

$$(a) \quad \int_a^b f(x) dx < \infty \quad \text{if} \quad \int_a^b g(x) dx < \infty$$

*and*

$$(b) \quad \int_a^b g(x) dx = \infty \quad \text{if} \quad \int_a^b f(x) dx = \infty.$$

**Proof** (a) Assumption (3.4.2) implies that

$$\int_a^x f(t) dt \leq \int_a^x g(t) dt, \quad a \leq x < b$$

(Theorem 3.3.4), so

$$\sup_{a \leq x < b} \int_a^x f(t) dt \leq \sup_{a \leq x < b} \int_a^x g(t) dt.$$

If  $\int_a^b g(x) dx < \infty$ , the right side of this inequality is finite by Theorem 3.4.5, so the left side is also. This implies that  $\int_a^b f(x) dx < \infty$ , again by Theorem 3.4.5.

(b) The proof is by contradiction. If  $\int_a^b g(x) dx < \infty$ , then (a) implies that  $\int_a^b f(x) dx < \infty$ , contradicting the assumption that  $\int_a^b f(x) dx = \infty$ . ■

The comparison test is particularly useful if the integrand of the improper integral is complicated but can be compared with a function that is easy to integrate.

**Example 3.4.8** The improper integral

$$I = \int_0^1 \frac{2 + \sin \pi x}{(1-x)^p} dx$$

converges if  $p < 1$ , since

$$0 < \frac{2 + \sin \pi x}{(1-x)^p} \leq \frac{3}{(1-x)^p}, \quad 0 \leq x < 1,$$

and, from Example 3.4.2,

$$\int_0^1 \frac{3 dx}{(1-x)^p} < \infty, \quad p < 1.$$

However,  $I$  diverges if  $p \geq 1$ , since

$$0 < \frac{1}{(1-x)^p} \leq \frac{2 + \sin \pi x}{(1-x)^p}, \quad 0 \leq x < 1,$$

and

$$\int_0^1 \frac{dx}{(1-x)^p} = \infty, \quad p \geq 1. \quad \blacksquare$$

If  $f$  is any function (not necessarily nonnegative) locally integrable on  $[a, b)$ , then

$$\int_a^c f(x) dx = \int_a^{a_1} f(x) dx + \int_{a_1}^c f(x) dx$$

if  $a_1$  and  $c$  are in  $[a, b)$ . Since  $\int_a^{a_1} f(x) dx$  is a proper integral, on letting  $c \rightarrow b^-$  we conclude that if either of the improper integrals  $\int_a^b f(x) dx$  and  $\int_{a_1}^b f(x) dx$  converges then so does the other, and in this case

$$\int_a^b f(x) dx = \int_a^{a_1} f(x) dx + \int_{a_1}^b f(x) dx.$$

This means that any theorem implying convergence or divergence of an improper integral  $\int_a^b f(x) dx$  in the sense of Definition 3.4.1 remains valid if its hypotheses are satisfied on a subinterval  $[a_1, b)$  of  $[a, b)$  rather than on all of  $[a, b)$ . For example, Theorem 3.4.6 remains valid if (3.4.2) is replaced by

$$0 \leq f(x) \leq g(x), \quad a_1 \leq x < b,$$

where  $a_1$  is any point in  $[a, b)$ .

From this, you can see that if  $f(x) \geq 0$  on some subinterval  $[a_1, b)$  of  $[a, b)$ , but not necessarily for all  $x$  in  $[a, b)$ , we can still use the convention introduced earlier for positive functions; that is, we can write  $\int_a^b f(x) dx < \infty$  if the improper integral converges or  $\int_a^b f(x) dx = \infty$  if it diverges.

**Example 3.4.9** If  $p \geq 0$ , then

$$\frac{x^{-p}}{2} \leq \frac{(x-1)^p(2+\sin x)}{(x-1/3)^{2p}} \leq 4x^{-p}$$

for  $x$  sufficiently large. Therefore, Theorem 3.4.6 and Example 3.4.3 imply that

$$\int_1^\infty \frac{(x-1)^p(2+\sin x)}{(x-1/3)^{2p}} dx$$

converges if  $p > 1$  or diverges if  $p \leq 1$ .

**Theorem 3.4.7** Suppose that  $f$  and  $g$  are locally integrable on  $[a, b)$ ,  $g(x) > 0$  and  $f(x) \geq 0$  on some subinterval  $[a_1, b)$  of  $[a, b)$ , and

$$\lim_{x \rightarrow b^-} \frac{f(x)}{g(x)} = M. \quad (3.4.3)$$

- (a) If  $0 < M < \infty$ , then  $\int_a^b f(x) dx$  and  $\int_a^b g(x) dx$  converge or diverge together.
- (b) If  $M = \infty$  and  $\int_a^b g(x) dx = \infty$ , then  $\int_a^b f(x) dx = \infty$ .
- (c) If  $M = 0$  and  $\int_a^b g(x) dx < \infty$ , then  $\int_a^b f(x) dx < \infty$ .

**Proof** (a) From (3.4.3), there is a point  $a_2$  in  $[a_1, b)$  such that

$$0 < \frac{M}{2} < \frac{f(x)}{g(x)} < \frac{3M}{2}, \quad a_2 \leq x < b,$$

and therefore

$$\frac{M}{2}g(x) < f(x) < \frac{3M}{2}g(x), \quad a_2 \leq x < b. \quad (3.4.4)$$

Theorem 3.4.6 and the first inequality in (3.4.4) imply that

$$\int_{a_2}^b g(x) dx < \infty \quad \text{if} \quad \int_{a_2}^b f(x) dx < \infty.$$

Theorem 3.4.6 and the second inequality in (3.4.4) imply that

$$\int_{a_2}^b f(x) dx < \infty \quad \text{if} \quad \int_{a_2}^b g(x) dx < \infty.$$

Therefore,  $\int_{a_2}^b f(x) dx$  and  $\int_{a_2}^b g(x) dx$  converge or diverge together, and in the latter case they must diverge to  $\infty$ , since their integrands are nonnegative (Theorem 3.4.5).

(b) If  $M = \infty$ , there is a point  $a_2$  in  $[a_1, b)$  such that

$$f(x) \geq g(x), \quad a_2 \leq x \leq b,$$

so Theorem 3.4.6(b) implies that  $\int_a^b f(x) dx = \infty$ .

(c) If  $M = 0$ , there is a point  $a_2$  in  $[a_1, b)$  such that

$$f(x) \leq g(x), \quad a_2 \leq x \leq b,$$

so Theorem 3.4.6(a) implies that  $\int_a^b f(x) dx < \infty$ . ■

The hypotheses of Theorem 3.4.7(b) and (c) do not imply that  $\int_a^b f(x) dx$  and  $\int_a^b g(x) dx$  necessarily converge or diverge together. For example, if  $b = \infty$ , then  $f(x) = 1/x$  and  $g(x) = 1/x^2$  satisfy the hypotheses of Theorem 3.4.7(b), while  $f(x) = 1/x^2$  and  $g(x) = 1/x$  satisfy the hypotheses of Theorem 3.4.7(c). However,  $\int_1^\infty 1/x dx = \infty$ , while  $\int_1^\infty 1/x^2 dx < \infty$ .

**Example 3.4.10** Let  $f(x) = (1+x)^{-p}$  and  $g(x) = x^{-p}$ . Since

$$\lim_{x \rightarrow \infty} \frac{f(x)}{g(x)} = 1$$

and  $\int_1^\infty x^{-p} dx$  converges if  $p > 1$  or diverges if  $p \leq 1$  (Example 3.4.3), Theorem 3.4.7 implies that the same is true of

$$\int_1^\infty (1+x)^{-p} dx.$$

**Example 3.4.11** The function

$$f(x) = x^{-p}(1+x)^{-q}$$

is locally integrable on  $(0, \infty)$ . To see whether

$$I = \int_0^\infty x^{-p}(1+x)^{-q} dx$$

converges according to Definition 3.4.3, we consider the improper integrals

$$I_1 = \int_0^1 x^{-p}(1+x)^{-q} dx \quad \text{and} \quad I_2 = \int_1^\infty x^{-p}(1+x)^{-q} dx$$



separately. (The choice of 1 as the upper limit of  $I_1$  and the lower limit of  $I_2$  is completely arbitrary; any other positive number would do just as well.) Since

$$\lim_{x \rightarrow 0^+} \frac{f(x)}{x^{-p}} = \lim_{x \rightarrow 0^+} (1+x)^{-q} = 1$$

and

$$\int_0^1 x^{-p} dx = \begin{cases} (1-p)^{-1}, & p < 1, \\ \infty, & p \geq 1, \end{cases}$$

Theorem 3.4.7 implies that  $I_1$  converges if and only if  $p < 1$ . Since

$$\lim_{x \rightarrow \infty} \frac{f(x)}{x^{-p-q}} = \lim_{x \rightarrow \infty} (1+x)^{-q} x^q = 1$$

and

$$\int_1^{\infty} x^{-p-q} dx = \begin{cases} (p+q-1)^{-1}, & p+q > 1, \\ \infty, & p+q \leq 1, \end{cases}$$

Theorem 3.4.7 implies that  $I_2$  converges if and only if  $p+q > 1$ . Combining these results, we conclude that  $I$  converges according to Definition 3.4.3 if and only if  $p < 1$  and  $p+q > 1$ .

### Absolute Integrability

**Definition 3.4.8** We say that  $f$  is *absolutely integrable* on  $[a, b)$  if  $f$  is locally integrable on  $[a, b)$  and  $\int_a^b |f(x)| dx < \infty$ . In this case we also say that  $\int_a^b f(x) dx$  *converges absolutely* or *is absolutely convergent*.

**Example 3.4.12** If  $f$  is nonnegative and integrable on  $[a, b)$ , then  $f$  is absolutely integrable on  $[a, b)$ , since  $|f| = f$ .

**Example 3.4.13** Since

$$\left| \frac{\sin x}{x^p} \right| \leq \frac{1}{x^p}$$

and  $\int_1^{\infty} x^{-p} dx < \infty$  if  $p > 1$  (Example 3.4.3), Theorem 3.4.6 implies that

$$\int_1^{\infty} \frac{|\sin x|}{x^p} dx < \infty, \quad p > 1;$$

that is, the function

$$f(x) = \frac{\sin x}{x^p}$$

is absolutely integrable on  $[1, \infty)$  if  $p > 1$ . It is not absolutely integrable on  $[1, \infty)$  if  $p \leq 1$ . To see this, we first consider the case where  $p = 1$ . Let  $k$  be an integer greater than 3. Then

$$\begin{aligned}
\int_1^{k\pi} \frac{|\sin x|}{x} dx &> \int_{\pi}^{k\pi} \frac{|\sin x|}{x} dx \\
&= \sum_{j=1}^{k-1} \int_{j\pi}^{(j+1)\pi} \frac{|\sin x|}{x} dx \\
&> \sum_{j=1}^{k-1} \frac{1}{(j+1)\pi} \int_{j\pi}^{(j+1)\pi} |\sin x| dx.
\end{aligned} \tag{3.4.5}$$

But

$$\int_{j\pi}^{(j+1)\pi} |\sin x| dx = \int_0^{\pi} \sin x dx = 2,$$

so (3.4.5) implies that

$$\int_1^{k\pi} \frac{|\sin x|}{x} dx > \frac{2}{\pi} \sum_{j=1}^{k-1} \frac{1}{j+1}. \tag{3.4.6}$$

However,

$$\frac{1}{j+1} \geq \int_{j+1}^{j+2} \frac{dx}{x}, \quad j = 1, 2, \dots,$$

so (3.4.6) implies that

$$\begin{aligned}
\int_1^{k\pi} \frac{|\sin x|}{x} dx &> \frac{2}{\pi} \sum_{j=1}^{k-1} \int_{j+1}^{j+2} \frac{dx}{x} \\
&= \frac{2}{\pi} \int_2^{k+1} \frac{dx}{x} = \frac{2}{\pi} \log \frac{k+1}{2}.
\end{aligned}$$

Since  $\lim_{k \rightarrow \infty} \log[(k+1)/2] = \infty$ , Theorem 3.4.5 implies that

$$\int_1^{\infty} \frac{|\sin x|}{x} dx = \infty.$$

Now Theorem 3.4.6(b) implies that

$$\int_1^{\infty} \frac{|\sin x|}{x^p} dx = \infty, \quad p \leq 1. \tag{3.4.7}$$

**Theorem 3.4.9** *If  $f$  is locally integrable on  $[a, b)$  and  $\int_a^b |f(x)| dx < \infty$ , then  $\int_a^b f(x) dx$  converges; that is, an absolutely convergent integral is convergent.*

**Proof** If

$$g(x) = |f(x)| - f(x),$$

then

$$0 \leq g(x) \leq 2|f(x)|$$

and  $\int_a^b g(x) dx < \infty$ , because of Theorem 3.4.6 and the absolute integrability of  $f$ . Since

$$f = |f| - g,$$

Theorem 3.4.4 implies that  $\int_a^b f(x) dx$  converges. ■

### Conditional Convergence

We say that  $f$  is *nonoscillatory* at  $b^-$  ( $= \infty$  if  $b = \infty$ ) if  $f$  is defined on  $[a, b)$  and does not change sign on some subinterval  $[a_1, b)$  of  $[a, b)$ . If  $f$  changes sign on every such subinterval,  $f$  is *oscillatory* at  $b^-$ . For a function that is locally integrable on  $[a, b)$  and nonoscillatory at  $b^-$ , convergence and absolute convergence of  $\int_a^b f(x) dx$  amount to the same thing (Exercise 3.4.16), so absolute convergence is not an interesting concept in connection with such functions. However, an oscillatory function may be integrable, but not absolutely integrable, on  $[a, b)$ , as the next example shows. We then say that  $f$  is *conditionally* integrable on  $[a, b)$ , and that  $\int_a^b f(x) dx$  converges *conditionally*.

**Example 3.4.14** We saw in Example 3.4.13 that the integral

$$I(p) = \int_1^\infty \frac{\sin x}{x^p} dx$$

is not absolutely convergent if  $0 < p \leq 1$ . We will show that it converges conditionally for these values of  $p$ .

Integration by parts yields

$$\int_1^c \frac{\sin x}{x^p} dx = \frac{-\cos c}{c^p} + \cos 1 - p \int_1^c \frac{\cos x}{x^{p+1}} dx. \quad (3.4.8)$$

Since

$$\left| \frac{\cos x}{x^{p+1}} \right| \leq \frac{1}{x^{p+1}}$$

and  $\int_1^\infty x^{-p-1} dx < \infty$  if  $p > 0$ , Theorem 3.4.6 implies that  $x^{-p-1} \cos x$  is absolutely integrable  $[1, \infty)$  if  $p > 0$ . Therefore, Theorem 3.4.9 implies that  $x^{-p-1} \cos x$  is integrable  $[1, \infty)$  if  $p > 0$ . Letting  $c \rightarrow \infty$  in (3.4.8), we find that  $I(p)$  converges, and

$$I(p) = \cos 1 - p \int_1^\infty \frac{\cos x}{x^{p+1}} dx \quad \text{if } p > 0.$$

This and (3.4.7) imply that  $I(p)$  converges conditionally if  $0 < p \leq 1$ . ■

The method used in Example 3.4.14 is a special case of the following test for convergence of improper integrals.

**Theorem 3.4.10 (Dirichlet's Test)** Suppose that  $f$  is continuous and its antiderivative  $F(x) = \int_a^x f(t) dt$  is bounded on  $[a, b)$ . Let  $g'$  be absolutely integrable on  $[a, b)$ , and suppose that

$$\lim_{x \rightarrow b^-} g(x) = 0. \quad (3.4.9)$$

Then  $\int_a^b f(x)g(x) dx$  converges.

**Proof** The continuous function  $fg$  is locally integrable on  $[a, b)$ . Integration by parts yields

$$\int_a^c f(x)g(x) dx = F(c)g(c) - \int_a^c F(x)g'(x) dx, \quad a \leq c < b. \quad (3.4.10)$$

Theorem 3.4.6 implies that the integral on the right converges absolutely as  $c \rightarrow b^-$ , since  $\int_a^b |g'(x)| dx < \infty$  by assumption, and

$$|F(x)g'(x)| \leq M|g'(x)|,$$

where  $M$  is an upper bound for  $|F|$  on  $[a, b)$ . Moreover, (3.4.9) and the boundedness of  $F$  imply that  $\lim_{c \rightarrow b^-} F(c)g(c) = 0$ . Letting  $c \rightarrow b^-$  in (3.4.10) yields

$$\int_a^b f(x)g(x) dx = - \int_a^b F(x)g'(x) dx,$$

where the integral on the right converges absolutely. ■

Dirichlet's test is useful only if  $f$  is oscillatory at  $b^-$ , since it can be shown that if  $f$  is nonoscillatory at  $b^-$  and  $F$  is bounded on  $[a, b)$ , then  $\int_a^b |f(x)g(x)| dx < \infty$  if only  $g$  is locally integrable and bounded on  $[a, b)$  (Exercise 3.4.14).

**Example 3.4.15** Dirichlet's test can also be used to show that certain integrals diverge. For example,

$$\int_1^\infty x^q \sin x dx$$

diverges if  $q > 0$ , but none of the other tests that we have studied so far implies this. It is not enough to argue that the integrand does not approach zero as  $x \rightarrow \infty$  (a common mistake), since this does not imply divergence (Exercise 4.4.31). To see that the integral diverges, we observe that if it converged for some  $q > 0$ , then  $F(x) = \int_1^x x^q \sin x dx$  would be bounded on  $[1, \infty)$ , and we could let

$$f(x) = x^q \sin x \quad \text{and} \quad g(x) = x^{-q}$$

in Theorem 3.4.10 and conclude that

$$\int_1^\infty \sin x dx$$

also converges. This is false. ■

The method used in Example 3.4.15 is a special case of the following test for divergence of improper integrals.

**Theorem 3.4.11** Suppose that  $u$  is continuous on  $[a, b)$  and  $\int_a^b u(x) dx$  diverges. Let  $v$  be positive and differentiable on  $[a, b)$ , and suppose that  $\lim_{x \rightarrow b^-} v(x) = \infty$  and  $v'/v^2$  is absolutely integrable on  $[a, b)$ . Then  $\int_a^b u(x)v(x) dx$  diverges.

**Proof** The proof is by contradiction. Let  $f = uv$  and  $g = 1/v$ , and suppose that  $\int_a^b u(x)v(x) dx$  converges. Then  $f$  has the bounded antiderivative  $F(x) = \int_a^x u(t)v(t) dt$  on  $[a, b)$ ,  $\lim_{x \rightarrow \infty} g(x) = 0$  and  $g' = -v'/v^2$  is absolutely integrable on  $[a, b)$ . Therefore, Theorem 3.4.10 implies that  $\int_a^b u(x) dx$  converges, a contradiction. ■

If Dirichlet's test shows that  $\int_a^b f(x)g(x) dx$  converges, there remains the question of whether it converges absolutely or conditionally. The next theorem sometimes answers this question. Its proof can be modeled after the method of Example 3.4.13 (Exercise 3.4.17). The idea of an infinite sequence, which we will discuss in Section 4.1, enters into the statement of this theorem. We assume that you recall the concept sufficiently well from calculus to understand the meaning of the theorem.

**Theorem 3.4.12** Suppose that  $g$  is monotonic on  $[a, b)$  and  $\int_a^b g(x) dx = \infty$ . Let  $f$  be locally integrable on  $[a, b)$  and

$$\int_{x_j}^{x_{j+1}} |f(x)| dx \geq \rho, \quad j \geq 0,$$

for some positive  $\rho$ , where  $\{x_j\}$  is an increasing infinite sequence of points in  $[a, b)$  such that  $\lim_{j \rightarrow \infty} x_j = b$  and  $x_{j+1} - x_j \leq M$ ,  $j \geq 0$ , for some  $M$ . Then

$$\int_a^b |f(x)g(x)| dx = \infty.$$

### Change of Variable in an Improper Integral

The next theorem enables us to investigate an improper integral by transforming it into another whose convergence or divergence is known. It follows from Theorem 3.3.18 and Definitions 3.4.1, 3.4.2, and 3.4.3. We omit the proof.

**Theorem 3.4.13** Suppose that  $\phi$  is monotonic and  $\phi'$  is locally integrable on either of the half-open intervals  $I = [c, d)$  or  $(c, d]$ , and let  $x = \phi(t)$  map  $I$  onto either of the half-open intervals  $J = [a, b)$  or  $J = (a, b]$ . Let  $f$  be locally integrable on  $J$ . Then the improper integrals

$$\int_a^b f(x) dx \quad \text{and} \quad \int_c^d f(\phi(t)) |\phi'(t)| dt$$

diverge or converge together, in the latter case to the same value. The same conclusion holds if  $\phi$  and  $\phi'$  have the stated properties only on the open interval  $(a, b)$ , the transformation  $x = \phi(t)$  maps  $(c, d)$  onto  $(a, b)$ , and  $f$  is locally integrable on  $(a, b)$ .

**Example 3.4.16** To apply Theorem 3.4.13 to

$$\int_0^{\infty} \sin x^2 dx,$$

we use the change of variable  $x = \phi(t) = \sqrt{t}$ , which takes  $[c, d) = [0, \infty)$  into  $[a, b) = [0, \infty)$ , with  $\phi'(t) = 1/(2\sqrt{t})$ . Theorem 3.4.13 implies that

$$\int_0^{\infty} \sin x^2 dx = \frac{1}{2} \int_0^{\infty} \frac{\sin t}{\sqrt{t}} dt.$$

Since the integral on the right converges (Example 3.4.14), so does the one on the left.

**Example 3.4.17** The integral

$$\int_1^{\infty} x^{-p} dx$$

converges if and only if  $p > 1$  (Example 3.4.3). Defining  $\phi(t) = 1/t$  and applying Theorem 3.4.13 yields

$$\int_1^{\infty} x^{-p} dx = \int_0^1 t^p | -t^{-2} | dt = \int_0^1 t^{p-2} dt,$$

which implies that  $\int_0^1 t^q dt$  converges if and only if  $q > -1$ .

### 3.4 Exercises

1. (a) Let  $f$  be locally integrable and bounded on  $[a, b)$ , and let  $f(b)$  be defined arbitrarily. Show that  $f$  is properly integrable on  $[a, b]$ , that  $\int_a^b f(x) dx$  does not depend on  $f(b)$ , and that

$$\int_a^b f(x) dx = \lim_{c \rightarrow b^-} \int_a^c f(x) dx.$$

- (b) State a result analogous to (a) which ends with the conclusion that

$$\int_a^b f(x) dx = \lim_{c \rightarrow a^+} \int_c^b f(x) dx.$$

2. Show that neither the existence nor the value of the improper integral of Definition 3.4.3 depends on the choice of the intermediate point  $\alpha$ .

3. Prove: If  $\int_a^b f(x) dx$  exists according to Definition 3.4.1 or 3.4.2, then  $\int_a^b f(x) dx$  also exists according to Definition 3.4.3.
4. Find all values of  $p$  for which the following integrals exist (i) as proper integrals (perhaps after defining  $f$  at the endpoints of the interval) or (ii) as improper integrals. (iii) Evaluate the integrals for the values of  $p$  for which they converge.

$$(a) \int_0^{1/\pi} \left( px^{p-1} \sin \frac{1}{x} - x^{p-2} \cos \frac{1}{x} \right) dx$$

$$(b) \int_0^{2/\pi} \left( px^{p-1} \frac{\cos}{1} x + x^{p-2} \sin \frac{1}{x} \right) dx$$

$$(c) \int_0^\infty e^{-px} dx \quad (d) \int_0^1 x^{-p} dx \quad (e) \int_0^\infty x^{-p} dx.$$

5. Evaluate

$$(a) \int_0^\infty e^{-x} x^n dx \quad (n = 0, 1, \dots) \quad (b) \int_0^\infty e^{-x} \sin x dx$$

$$(c) \int_{-\infty}^\infty \frac{x dx}{x^2 + 1} \quad (d) \int_0^1 \frac{x dx}{\sqrt{1-x^2}}$$

$$(e) \int_0^\pi \left( \frac{\cos x}{x} - \frac{\sin x}{x^2} \right) dx \quad (f) \int_{\pi/2}^\infty \left( \frac{\sin x}{x} + \frac{\cos x}{x^2} \right) dx$$

6. Prove: If  $\int_a^b f(x) dx$  exists as a proper or improper integral, then

$$\lim_{x \rightarrow b^-} \int_x^b f(t) dt = 0.$$

7. Prove: If  $f$  is locally integrable on  $[a, b)$ , then  $\int_a^b f(x) dx$  exists if and only if for each  $\epsilon > 0$  there is a number  $r$  in  $(a, b)$  such that

$$\left| \int_{x_1}^{x_2} f(t) dt \right| < \epsilon$$

whenever  $r \leq x_1, x_2 < b$ . HINT: See Exercise 2.1.38.

8. Determine whether the integral converges or diverges.

$$(a) \int_1^\infty \frac{\log x + \sin x}{\sqrt{x}} dx \quad (b) \int_{-\infty}^\infty \frac{(x^2 + 3)^{3/2}}{(x^4 + 1)^{3/2}} \sin^2 x dx$$

$$(c) \int_0^\infty \frac{1 + \cos^2 x}{\sqrt{1+x^2}} dx \quad (d) \int_0^\infty \frac{4 + \cos x}{(1+x)\sqrt{x}} dx$$

$$(e) \int_0^\infty (x^{27} + \sin x)e^{-x} dx \quad (f) \int_0^\infty x^{-p}(2 + \sin x) dx$$

9. Find all values of  $p$  for which the integral converges.

$$(a) \int_0^{\pi/2} \frac{\sin x}{x^p} dx \quad (b) \int_0^{\pi/2} \frac{\cos x}{x^p} dx \quad (c) \int_0^{\infty} x^p e^{-x} dx$$

$$(d) \int_0^{\pi/2} \frac{\sin x}{(\tan x)^p} dx \quad (e) \int_1^{\infty} \frac{dx}{x(\log x)^p} \quad (f) \int_0^1 \frac{dx}{x(|\log x|)^p}$$

$$(g) \int_0^{\pi} \frac{x dx}{(\sin x)^p}$$

10. Let  $L_n(x)$  be the iterated logarithm defined in Exercise 2.4.42. Show that

$$\int_a^{\infty} \frac{dx}{L_0(x)L_1(x)\cdots L_k(x)[L_{k+1}(x)]^p}$$

converges if and only if  $p > 1$ . Here  $a$  is any number such that  $L_{k+1}(x) > 0$  for  $x \geq a$ .

11. Find conditions on  $p$  and  $q$  such that the integral converges.

$$(a) \int_{-1}^1 \frac{(\cos \pi x/2)^q}{(1-x^2)^p} dx \quad (b) \int_{-1}^1 (1-x)^p (1+x)^q dx$$

$$(c) \int_0^{\infty} \frac{x^p dx}{(1+x^2)^q} \quad (d) \int_1^{\infty} \frac{[\log(1+x)]^p (\log x)^q}{x^{p+q}} dx$$

$$(e) \int_1^{\infty} \frac{(\log(1+x) - \log x)^q}{x^p} dx \quad (f) \int_0^{\infty} \frac{(x - \sin x)^q}{x^p} dx$$

12. Let  $f$  and  $g$  be polynomials and suppose that  $g$  has no real zeros. Find necessary and sufficient conditions for convergence of

$$\int_{-\infty}^{\infty} \frac{f(x)}{g(x)} dx.$$

13. Prove: If  $f$  and  $g$  are locally integrable on  $[a, b)$  and the improper integrals  $\int_a^b f^2(x) dx$  and  $\int_a^b g^2(x) dx$  converge, then  $\int_a^b f(x)g(x) dx$  converges absolutely. HINT:  $(f \pm g)^2 \geq 0$ .

14. Suppose that  $f$  is locally integrable and  $F(x) = \int_a^x f(t) dt$  is bounded on  $[a, b)$ , and let  $f$  be nonoscillatory at  $b-$ . Let  $g$  be locally integrable and bounded on  $[a, b)$ . Show that

$$\int_a^b |f(x)g(x)| dx < \infty.$$

15. Suppose that  $g$  is positive and nonincreasing on  $[a, b)$  and  $\int_a^b f(x) dx$  exists as a proper or absolutely convergent improper integral. Show that  $\int_a^b f(x)g(x) dx$  exists and



$$\lim_{x \rightarrow b^-} \frac{1}{g(x)} \int_x^b f(t)g(t) dt = 0.$$

HINT: Use Exercise 3.4.6.

16. Show that if  $f$  is locally integrable on  $[a, b)$  and nonoscillatory at  $b^-$ , then  $\int_a^b f(x) dx$  exists if and only if  $\int_a^b |f(x)| dx < \infty$ .
17. (a) Prove Theorem 3.4.12. HINT: See Example 3.4.13.  
 (b) Show that  $g$  satisfies the assumptions of Theorem 3.4.10 if  $g'$  is locally integrable,  $g$  is monotonic on  $[a, b)$ , and  $\lim_{x \rightarrow b^-} g(x) = 0$ .
18. Find all values of  $p$  for which the integral converges (i) absolutely; (ii) conditionally.
- (a)  $\int_1^\infty \frac{\cos x}{x^p} dx$       (b)  $\int_2^\infty \frac{\sin x}{x(\log x)^p} dx$       (c)  $\int_2^\infty \frac{\sin x}{x^p \log x} dx$
- (d)  $\int_1^\infty \frac{\sin 1/x}{x^p} dx$       (e)  $\int_0^\infty \frac{\sin^2 x \sin 2x}{x^p} dx$       (f)  $\int_{-\infty}^\infty \frac{\sin x}{(1+x^2)^p} dx$
19. Suppose that  $g''$  is absolutely integrable on  $[0, \infty)$ ,  $\lim_{x \rightarrow \infty} g'(x) = 0$ , and  $\lim_{x \rightarrow \infty} g(x) = L$  (finite or infinite). Show that  $\int_0^\infty g(x) \sin x dx$  converges if and only if  $L = 0$ .  
 HINT: Integrate by parts.
20. Let  $h$  be continuous on  $[0, \infty)$ . Prove:  
 (a) If  $\int_0^\infty e^{-s_0 x} h(x) dx$  converges absolutely, then  $\int_0^\infty e^{-sx} h(x) dx$  converges absolutely if  $s > s_0$ .  
 (b) If  $\int_0^\infty e^{-s_0 x} h(x) dx$  converges, then  $\int_0^\infty e^{-sx} h(x) dx$  converges if  $s > s_0$ .
21. Suppose that  $f$  is locally integrable on  $[0, \infty)$ ,  $\lim_{x \rightarrow \infty} f(x) = A$ , and  $\alpha > -1$ . Find  $\lim_{x \rightarrow \infty} x^{-\alpha-1} \int_0^x f(t)t^\alpha dt$ , and prove your answer.
22. Suppose that  $f$  is continuous and  $F(x) = \int_a^x f(t) dt$  is bounded on  $[a, b)$ . Suppose also that  $g > 0$ ,  $g'$  is nonnegative and locally integrable on  $[a, b)$ , and  $\lim_{x \rightarrow b^-} g(x) = \infty$ . Show that

$$\lim_{x \rightarrow b^-} \frac{1}{[g(x)]^\rho} \int_a^x f(t)g(t) dt = 0, \quad \rho > 1.$$

HINT: Integrate by parts.

23. In addition to the assumptions of Exercise 3.4.22, assume that  $\int_a^b f(t) dt$  converges. Show that

$$\lim_{x \rightarrow b^-} \frac{1}{g(x)} \int_a^x f(t)g(t) dt = 0.$$

HINT: Let  $F(x) = \int_x^b f(t) dt$ , integrate by parts, and use Exercise 3.4.6.

24. Suppose that  $f$  is continuous,  $g'(x) \leq 0$ , and  $g(x) > 0$  on  $[a, b)$ . Show that if  $g'$  is integrable on  $[a, b)$  and  $\int_a^b f(x) dx$  exists, then  $\int_a^b f(x)g(x) dx$  exists and

$$\lim_{x \rightarrow b^-} \frac{1}{g(x)} \int_x^b f(t)g(t) dt = 0.$$

HINT: Let  $F(x) = \int_x^b f(t) dt$ , integrate by parts, and use Exercise 3.4.6.

25. Find all values of  $p$  for which the integral converges (i) absolutely; (ii) conditionally.

(a)  $\int_0^1 x^p \sin 1/x dx$       (b)  $\int_0^1 |\log x|^p dx$       (c)  $\int_1^\infty x^p \cos(\log x) dx$

(d)  $\int_1^\infty (\log x)^p dx$       (e)  $\int_0^\infty \sin x^p dx$

26. Let  $u_1$  be positive and satisfy the differential equation

$$u'' + p(x)u = 0, \quad 0 \leq x < \infty. \quad (\text{A})$$

- (a) Prove: If

$$\int_0^\infty \frac{dx}{u_1^2(x)} < \infty,$$

then the function

$$u_2(x) = u_1(x) \int_x^\infty \frac{dt}{u_1^2(t)}$$

also satisfies (A), while if

$$\int_0^\infty \frac{dx}{u_1^2(x)} = \infty,$$

then the function

$$u_2(x) = u_1(x) \int_0^x \frac{dt}{u_1^2(t)}$$

also satisfies (A).

- (b) Prove: If (A) has a solution that is positive on  $[0, \infty)$ , then (A) has solutions  $y_1$  and  $y_2$  that are positive on  $(0, \infty)$  and have the following properties:

$$y_1(x)y_2'(x) - y_1'(x)y_2(x) = 1, \quad x > 0,$$

$$\left[ \frac{y_1(x)}{y_2(x)} \right]' < 0, \quad x > 0,$$

and

$$\lim_{x \rightarrow \infty} \frac{y_1(x)}{y_2(x)} = 0.$$

27. (a) Prove: If  $h$  is continuous on  $[0, \infty)$ , then the function

$$u(x) = c_1 e^{-x} + c_2 e^x + \int_0^x h(t) \sinh(x-t) dt$$

satisfies the differential equation

$$u'' - u = h(x), \quad x > 0.$$

- (b) Rewrite  $u$  in the form

$$u(x) = a(x)e^{-x} + b(x)e^x$$

and show that

$$u'(x) = -a(x)e^{-x} + b(x)e^x.$$

- (c) Show that if  $\lim_{x \rightarrow \infty} a(x) = A$  (finite), then

$$\lim_{x \rightarrow \infty} e^{2x} [b(x) - B] = 0$$

for some constant  $B$ . HINT: Use Exercise 3.4.24. Show also that

$$\lim_{x \rightarrow \infty} e^x [u(x) - Ae^{-x} - Be^x] = 0.$$

- (d) Prove: If  $\lim_{x \rightarrow \infty} b(x) = B$  (finite), then

$$\lim_{x \rightarrow \infty} u(x)e^{-x} = \lim_{x \rightarrow \infty} u'(x)e^{-x} = B.$$

HINT: Use Exercise 3.4.23.

28. Suppose that the differential equation

$$u'' + p(x)u = 0 \tag{A}$$

has a positive solution on  $[0, \infty)$ , and therefore has two solutions  $y_1$  and  $y_2$  with the properties given in Exercise 3.4.26(b).

- (a) Prove: If  $h$  is continuous on  $[0, \infty)$  and  $c_1$  and  $c_2$  are constants, then

$$u(x) = c_1 y_1(x) + c_2 y_2(x) + \int_0^x h(t) [y_1(t)y_2(x) - y_1(x)y_2(t)] dt \tag{B}$$

satisfies the differential equation

$$u'' + p(x)u = h(x).$$

For convenience in (b) and (c), rewrite (B) as

$$u(x) = a(x)y_1(x) + b(x)y_2(x).$$

(b) Prove: If  $\int_0^\infty h(t)y_2(t) dt$  converges, then  $\int_0^\infty h(t)y_1(t) dt$  converges, and

$$\lim_{x \rightarrow \infty} \frac{u(x) - Ay_1(x) - By_2(x)}{y_1(x)} = 0$$

for some constants  $A$  and  $B$ . HINT: Use Exercise 3.4.24 with  $f = hy_2$  and  $g = y_1/y_2$ .

(c) Prove: If  $\int_0^\infty h(t)y_1(t) dt$  converges, then

$$\lim_{x \rightarrow \infty} \frac{u(x)}{y_2(x)} = B$$

for some constant  $B$ . HINT: Use Exercise 3.4.23 with  $f = hy_1$  and  $g = y_2/y_1$ .

29. Suppose that  $f$ ,  $f_1$ , and  $g$  are continuous,  $f > 0$ , and  $(f_1/f)'$  is absolutely integrable on  $[a, b)$ . Show that  $\int_a^b f_1(x)g(x) dx$  converges if  $\int_a^b f(x)g(x) dx$  does.
30. Let  $g$  be locally integrable and  $f$  continuous, with  $f(x) \geq \rho > 0$  on  $[a, b)$ . Suppose that for some positive  $M$  and for every  $r$  in  $[a, b)$  there are points  $x_1$  and  $x_2$  such that (a)  $r < x_1 < x_2 < b$ ; (b)  $g$  does not change sign in  $[x_1, x_2]$ ; and (c)  $\int_{x_1}^{x_2} |g(x)| dx \geq M$ . Show that  $\int_a^b f(x)g(x) dx$  diverges. HINT: Use Exercise 3.4.7 and Theorem 3.3.7.

### 3.5 A MORE ADVANCED LOOK AT THE EXISTENCE OF THE PROPER RIEMANN INTEGRAL

In Section 3.2 we found necessary and sufficient conditions for existence of the proper Riemann integral, and in Section 3.3 we used them to study the properties of the integral. However, it is awkward to apply these conditions to a specific function and determine whether it is integrable, since they require computations of upper and lower sums and upper and lower integrals, which may be difficult. The main result of this section is an integrability criterion due to Lebesgue that does not require computation, but has to do with how badly discontinuous a function may be and still be integrable.

We emphasize that we are again considering proper integrals of bounded functions on finite intervals.

**Definition 3.5.1** If  $f$  is bounded on  $[a, b]$ , the *oscillation of  $f$  on  $[a, b]$*  is defined by

$$W_f[a, b] = \sup_{a \leq x, x' \leq b} |f(x) - f(x')|,$$

which can also be written as

$$W_f[a, b] = \sup_{a \leq x \leq b} f(x) - \inf_{a \leq x \leq b} f(x)$$

(Exercise 3.5.1). If  $a < x < b$ , the *oscillation of  $f$  at  $x$*  is defined by

$$w_f(x) = \lim_{h \rightarrow 0^+} W_f(x-h, x+h).$$

The corresponding definitions for  $x = a$  and  $x = b$  are

$$w_f(a) = \lim_{h \rightarrow 0^+} W_f(a, a+h) \quad \text{and} \quad w_f(b) = \lim_{h \rightarrow 0^+} W_f(b-h, b). \quad \blacksquare$$

For a fixed  $x$  in  $(a, b)$ ,  $W_f(x-h, x+h)$  is a nonnegative and nondecreasing function of  $h$  for  $0 < h < \min(x-a, b-x)$ ; therefore,  $w_f(x)$  exists and is nonnegative, by Theorem 2.1.9. Similar arguments apply to  $w_f(a)$  and  $w_f(b)$ .

**Theorem 3.5.2** *Let  $f$  be defined on  $[a, b]$ . Then  $f$  is continuous at  $x_0$  in  $[a, b]$  if and only if  $w_f(x_0) = 0$ . (Continuity at  $a$  or  $b$  means continuity from the right or left, respectively.)*

**Proof** Suppose that  $a < x_0 < b$ . First, suppose that  $w_f(x_0) = 0$  and  $\epsilon > 0$ . Then

$$W_f[x_0-h, x_0+h] < \epsilon$$

for some  $h > 0$ , so

$$|f(x) - f(x')| < \epsilon \quad \text{if} \quad x_0 - h \leq x, x' \leq x_0 + h.$$

Letting  $x' = x_0$ , we conclude that

$$|f(x) - f(x_0)| < \epsilon \quad \text{if} \quad |x - x_0| < h.$$

Therefore,  $f$  is continuous at  $x_0$ .

Conversely, if  $f$  is continuous at  $x_0$  and  $\epsilon > 0$ , there is a  $\delta > 0$  such that

$$|f(x) - f(x_0)| < \frac{\epsilon}{2} \quad \text{and} \quad |f(x') - f(x_0)| < \frac{\epsilon}{2}$$

if  $x_0 - \delta \leq x, x' \leq x_0 + \delta$ . From the triangle inequality,

$$|f(x) - f(x')| \leq |f(x) - f(x_0)| + |f(x') - f(x_0)| < \epsilon,$$

so

$$W_f[x_0-h, x_0+h] \leq \epsilon \quad \text{if} \quad h < \delta;$$

therefore,  $w_f(x_0) = 0$ . Similar arguments apply if  $x_0 = a$  or  $x_0 = b$ .  $\blacksquare$

**Lemma 3.5.3** *If  $w_f(x) < \epsilon$  for  $a \leq x \leq b$ , then there is a  $\delta > 0$  such that  $W_f[a_1, b_1] \leq \epsilon$ , provided that  $[a_1, b_1] \subset [a, b]$  and  $b_1 - a_1 < \delta$ .*

**Proof** We use the Heine–Borel theorem (Theorem 1.3.7). If  $w_f(x) < \epsilon$ , there is an  $h_x > 0$  such that

$$|f(x') - f(x'')| < \epsilon \tag{3.5.1}$$

if

$$x - 2h_x < x', x'' < x + 2h_x \quad \text{and} \quad x', x'' \in [a, b]. \quad (3.5.2)$$

If  $I_x = (x - h_x, x + h_x)$ , then the collection

$$\mathcal{H} = \{I_x \mid a \leq x \leq b\}$$

is an open covering of  $[a, b]$ , so the Heine–Borel theorem implies that there are finitely many points  $x_1, x_2, \dots, x_n$  in  $[a, b]$  such that  $I_{x_1}, I_{x_2}, \dots, I_{x_n}$  cover  $[a, b]$ . Let

$$h = \min_{1 \leq i \leq n} h_{x_i}$$

and suppose that  $[a_1, b_1] \subset [a, b]$  and  $b_1 - a_1 < h$ . If  $x'$  and  $x''$  are in  $[a_1, b_1]$ , then  $x' \in I_{x_r}$  for some  $r$  ( $1 \leq r \leq n$ ), so

$$|x' - x_r| < h_{x_r}.$$

Therefore,

$$\begin{aligned} |x'' - x_r| &\leq |x'' - x'| + |x' - x_r| < b_1 - a_1 + h_{x_r} \\ &< h + h_{x_r} \leq 2h_{x_r}. \end{aligned}$$

Thus, any two points  $x'$  and  $x''$  in  $[a_1, b_1]$  satisfy (3.5.2) with  $x = x_r$ , so they also satisfy (3.5.1). Therefore,  $\epsilon$  is an upper bound for the set

$$\{|f(x') - f(x'')| \mid x', x'' \in [a_1, b_1]\},$$

which has the supremum  $W_f[a_1, b_1]$ . Hence,  $W_f[a_1, b_1] \leq \epsilon$ . ■

In the following,  $L(I)$  is the length of the interval  $I$ .

**Lemma 3.5.4** *Let  $f$  be bounded on  $[a, b]$  and define*

$$E_\rho = \{x \in [a, b] \mid w_f(x) \geq \rho\}.$$

*Then  $E_\rho$  is closed, and  $f$  is integrable on  $[a, b]$  if and only if for every pair of positive numbers  $\rho$  and  $\delta$ ,  $E_\rho$  can be covered by finitely many open intervals  $I_1, I_2, \dots, I_p$  such that*

$$\sum_{j=1}^p L(I_j) < \delta. \quad (3.5.3)$$

**Proof** We first show that  $E_\rho$  is closed. Suppose that  $x_0$  is a limit point of  $E_\rho$ . If  $h > 0$ , there is an  $\bar{x}$  from  $E_\rho$  in  $(x_0 - h, x_0 + h)$ . Since  $[\bar{x} - h_1, \bar{x} + h_1] \subset [x_0 - h, x_0 + h]$  for sufficiently small  $h_1$  and  $W_f[\bar{x} - h_1, \bar{x} + h_1] \geq \rho$ , it follows that  $W_f[x_0 - h, x_0 + h] \geq \rho$  for all  $h > 0$ . This implies that  $x_0 \in E_\rho$ , so  $E_\rho$  is closed (Corollary 1.3.6).

Now we will show that the stated condition is necessary for integrability. Suppose that the condition is not satisfied; that is, there is a  $\rho > 0$  and a  $\delta > 0$  such that

$$\sum_{j=1}^p L(I_j) \geq \delta$$

for every finite set  $\{I_1, I_2, \dots, I_p\}$  of open intervals covering  $E_\rho$ . If  $P = \{x_0, x_1, \dots, x_n\}$  is a partition of  $[a, b]$ , then

$$S(P) - s(P) = \sum_{j \in A} (M_j - m_j)(x_j - x_{j-1}) + \sum_{j \in B} (M_j - m_j)(x_j - x_{j-1}), \quad (3.5.4)$$

where

$$A = \{j \mid [x_{j-1}, x_j] \cap E_\rho \neq \emptyset\} \quad \text{and} \quad B = \{j \mid [x_{j-1}, x_j] \cap E_\rho = \emptyset\}.$$

Since  $\bigcup_{j \in A} (x_{j-1}, x_j)$  contains all points of  $E_\rho$  except any of  $x_0, x_1, \dots, x_n$  that may be in  $E_\rho$ , and each of these finitely many possible exceptions can be covered by an open interval of length as small as we please, our assumption on  $E_\rho$  implies that

$$\sum_{j \in A} (x_j - x_{j-1}) \geq \delta.$$

Moreover, if  $j \in A$ , then

$$M_j - m_j \geq \rho,$$

so (3.5.4) implies that

$$S(P) - s(P) \geq \rho \sum_{j \in A} (x_j - x_{j-1}) \geq \rho \delta.$$

Since this holds for every partition of  $[a, b]$ ,  $f$  is not integrable on  $[a, b]$ , by Theorem 3.2.7. This proves that the stated condition is necessary for integrability.

For sufficiency, let  $\rho$  and  $\delta$  be positive numbers and let  $I_1, I_2, \dots, I_p$  be open intervals that cover  $E_\rho$  and satisfy (3.5.3). Let

$$\tilde{I}_j = [a, b] \cap \bar{I}_j.$$

( $\bar{I}_j$  = closure of  $I_j$ .) After combining any of  $\tilde{I}_1, \tilde{I}_2, \dots, \tilde{I}_p$  that overlap, we obtain a set of pairwise disjoint closed subintervals

$$C_j = [\alpha_j, \beta_j], \quad 1 \leq j \leq q (\leq p),$$

of  $[a, b]$  such that

$$a \leq \alpha_1 < \beta_1 < \alpha_2 < \beta_2 \cdots < \alpha_{q-1} < \beta_{q-1} < \alpha_q < \beta_q \leq b, \quad (3.5.5)$$

$$\sum_{i=1}^q (\beta_i - \alpha_i) < \delta \quad (3.5.6)$$

and

$$w_f(x) < \rho, \quad \beta_j \leq x \leq \alpha_{j+1}, \quad 1 \leq j \leq q-1.$$

Also,  $w_f(x) < \rho$  for  $a \leq x \leq \alpha_1$  if  $a < \alpha_1$  and for  $\beta_q \leq x \leq b$  if  $\beta_q < b$ .

Let  $P_0$  be the partition of  $[a, b]$  with the partition points indicated in (3.5.5), and refine  $P_0$  by partitioning each subinterval  $[\beta_j, \alpha_{j+1}]$  (as well as  $[a, \alpha_1]$  if  $a < \alpha_1$  and  $[\beta_q, b]$  if  $\beta_q < b$ ) into subintervals on which the oscillation of  $f$  is not greater than  $\rho$ . This is possible by Lemma 3.5.3. In this way, after renaming the entire collection of partition points, we obtain a partition  $P = \{x_0, x_1, \dots, x_n\}$  of  $[a, b]$  for which  $S(P) - s(P)$  can be written as in (3.5.4), with

$$\sum_{j \in A} (x_j - x_{j-1}) = \sum_{i=1}^q (\beta_i - \alpha_i) < \delta$$

(see (3.5.6)) and

$$M_j - m_j \leq \rho, \quad j \in B.$$

For this partition,

$$\sum_{j \in A} (M_j - m_j)(x_j - x_{j-1}) \leq 2K \sum_{j \in A} (x_j - x_{j-1}) < 2K\delta,$$

where  $K$  is an upper bound for  $|f|$  on  $[a, b]$  and

$$\sum_{j \in B} (M_j - m_j)(x_j - x_{j-1}) \leq \rho(b - a).$$

We have now shown that if  $\rho$  and  $\delta$  are arbitrary positive numbers, there is a partition  $P$  of  $[a, b]$  such that

$$S(P) - s(P) < 2K\delta + \rho(b - a). \quad (3.5.7)$$

If  $\epsilon > 0$ , let

$$\delta = \frac{\epsilon}{4K} \quad \text{and} \quad \rho = \frac{\epsilon}{2(b - a)}.$$

Then (3.5.7) yields

$$S(P) - s(P) < \epsilon,$$

and Theorem 3.2.7 implies that  $f$  is integrable on  $[a, b]$ . ■

We need the next definition to state Lebesgue's integrability condition.

**Definition 3.5.5** A subset  $S$  of the real line is of *Lebesgue measure zero* if for every  $\epsilon > 0$  there is a finite or infinite sequence of open intervals  $I_1, I_2, \dots$  such that

$$S \subset \bigcup_j I_j \quad (3.5.8)$$

and

$$\sum_{j=1}^n L(I_j) < \epsilon, \quad n \geq 1. \quad (3.5.9)$$

■



Note that any subset of a set of Lebesgue measure zero is also of Lebesgue measure zero. (Why?)

**Example 3.5.1** The empty set is of Lebesgue measure zero, since it is contained in any open interval.

**Example 3.5.2** Any finite set  $S = \{x_1, x_2, \dots, x_n\}$  is of Lebesgue measure zero, since we can choose open intervals  $I_1, I_2, \dots, I_n$  such that  $x_j \in I_j$  and  $L(I_j) < \epsilon/n$ ,  $1 \leq j \leq n$ .

**Example 3.5.3** An infinite set is *denumerable* if its members can be listed in a sequence (that is, in a one-to-one correspondence with the positive integers); thus,

$$S = \{x_1, x_2, \dots, x_n, \dots\}. \quad (3.5.10)$$

An infinite set that does not have this property is *nondenumerable*. Any denumerable set (3.5.10) is of Lebesgue measure zero, since if  $\epsilon > 0$ , it is possible to choose open intervals  $I_1, I_2, \dots$ , so that  $x_j \in I_j$  and  $L(I_j) < 2^{-j}\epsilon$ ,  $j \geq 1$ . Then (3.5.9) holds because

$$\frac{1}{2} + \frac{1}{2^2} + \frac{1}{2^3} + \dots + \frac{1}{2^n} = 1 - \frac{1}{2^n} < 1. \quad (3.5.11)$$

There are also nondenumerable sets of Lebesgue measure zero, but it is beyond the scope of this book to discuss examples.

The next theorem is the main result of this section.

**Theorem 3.5.6** *A bounded function  $f$  is integrable on a finite interval  $[a, b]$  if and only if the set  $S$  of discontinuities of  $f$  in  $[a, b]$  is of Lebesgue measure zero.*

**Proof** From Theorem 3.5.2,

$$S = \{x \in [a, b] \mid w_f(x) > 0\}.$$

Since  $w_f(x) > 0$  if and only if  $w_f(x) \geq 1/i$  for some positive integer  $i$ , we can write

$$S = \bigcup_{i=1}^{\infty} S_i, \quad (3.5.12)$$

where

$$S_i = \{x \in [a, b] \mid w_f(x) \geq 1/i\}.$$

Now suppose that  $f$  is integrable on  $[a, b]$  and  $\epsilon > 0$ . From Lemma 3.5.4, each  $S_i$  can be covered by a finite number of open intervals  $I_{i1}, I_{i2}, \dots, I_{in}$  of total length less than  $\epsilon/2^i$ . We simply renumber these intervals consecutively; thus,

$$I_1, I_2, \dots = I_{11}, \dots, I_{1n_1}, I_{21}, \dots, I_{2n_2}, \dots, I_{i1}, \dots, I_{in_i}, \dots$$

Now (3.5.8) and (3.5.9) hold because of (3.5.11) and (3.5.12), and we have shown that the stated condition is necessary for integrability.

For sufficiency, suppose that the stated condition holds and  $\epsilon > 0$ . Then  $S$  can be covered by open intervals  $I_1, I_2, \dots$  that satisfy (3.5.9). If  $\rho > 0$ , then the set

$$E_\rho = \{x \in [a, b] \mid w_f(x) \geq \rho\}$$

of Lemma 3.5.4 is contained in  $S$  (Theorem 3.5.2), and therefore  $E_\rho$  is covered by  $I_1, I_2, \dots$ . Since  $E_\rho$  is closed (Lemma 3.5.4) and bounded, the Heine–Borel theorem implies that  $E_\rho$  is covered by a finite number of intervals from  $I_1, I_2, \dots$ . The sum of the lengths of the latter is less than  $\epsilon$ , so Lemma 3.5.4 implies that  $f$  is integrable on  $[a, b]$ . ■

### 3.5 Exercises

1. In connection with Definition 3.5.1, show that

$$\sup_{x, x' \in [a, b]} |f(x) - f(x')| = \sup_{a \leq x \leq b} f(x) - \inf_{a \leq x \leq b} f(x).$$

2. Use Theorem 3.5.6 to show that if  $f$  is integrable on  $[a, b]$ , then so is  $|f|$  and, if  $f(x) \geq \rho > 0$  ( $a \leq x \leq b$ ), so is  $1/f$ .
3. Prove: The union of two sets of Lebesgue measure zero is of Lebesgue measure zero.
4. Use Theorem 3.5.6 and Exercise 3.5.3 to show that if  $f$  and  $g$  are integrable on  $[a, b]$ , then so are  $f + g$  and  $fg$ .
5. Suppose  $f$  is integrable on  $[a, b]$ ,  $\alpha = \inf_{a \leq x \leq b} f(x)$ , and  $\beta = \sup_{a \leq x \leq b} f(x)$ . Let  $g$  be continuous on  $[\alpha, \beta]$ . Show that the composition  $h = g \circ f$  is integrable on  $[a, b]$ .
6. Let  $f$  be integrable on  $[a, b]$ , let  $\alpha = \inf_{a \leq x \leq b} f(x)$  and  $\beta = \sup_{a \leq x \leq b} f(x)$ , and suppose that  $G$  is continuous on  $[\alpha, \beta]$ . For each  $n \geq 1$ , let

$$a + \frac{(j-1)(b-a)}{n} \leq u_{jn}, v_{jn} \leq a + \frac{j(b-a)}{n}, \quad 1 \leq j \leq n.$$

Show that

$$\lim_{n \rightarrow \infty} \frac{1}{n} \sum_{j=1}^n |G(f(u_{jn})) - G(f(v_{jn}))| = 0.$$

7. Let  $h(x) = 0$  for all  $x$  in  $[a, b]$  except for  $x$  in a set of Lebesgue measure zero. Show that if  $\int_a^b h(x) dx$  exists, it equals zero. HINT: Any subset of a set of measure zero is also of measure zero.
8. Suppose that  $f$  and  $g$  are integrable on  $[a, b]$  and  $f(x) = g(x)$  except for  $x$  in a set of Lebesgue measure zero. Show that

$$\int_a^b f(x) dx = \int_a^b g(x) dx.$$

## CHAPTER 4

### Infinite Sequences and Series

IN THIS CHAPTER we consider infinite sequences and series of constants and functions of a real variable.

SECTION 4.1 introduces infinite sequences of real numbers. The concept of a limit of a sequence is defined, as is the concept of divergence of a sequence to  $\pm\infty$ . We discuss bounded sequences and monotonic sequences. The limit inferior and limit superior of a sequence are defined. We prove the Cauchy convergence criterion for sequences of real numbers.

SECTION 4.2 defines a subsequence of an infinite sequence. We show that if a sequence converges to a limit or diverges to  $\pm\infty$ , then so do all subsequences of the sequence. Limit points and boundedness of a set of real numbers are discussed in terms of sequences of members of the set. Continuity and boundedness of a function are discussed in terms of the values of the function at sequences of points in its domain.

SECTION 4.3 introduces concepts of convergence and divergence to  $\pm\infty$  for infinite series of constants. We prove Cauchy's convergence criterion for a series of constants. In connection with series of positive terms, we consider the comparison test, the integral test, the ratio test, and Raabe's test. For general series, we consider absolute and conditional convergence, Dirichlet's test, rearrangement of terms, and multiplication of one infinite series by another.

SECTION 4.4 deals with pointwise and uniform convergence of sequences and series of functions. Cauchy's uniform convergence criteria for sequences and series are proved, as is Dirichlet's test for uniform convergence of a series. We give sufficient conditions for the limit of a sequence of functions or the sum of an infinite series of functions to be continuous, integrable, or differentiable.

SECTION 4.5 considers power series. It is shown that a power series that converges on an open interval defines an infinitely differentiable function on that interval. We define the Taylor series of an infinitely differentiable function, and give sufficient conditions for the Taylor series to converge to the function on some interval. Arithmetic operations with power series are discussed.

## 4.1 SEQUENCES OF REAL NUMBERS

An *infinite sequence* (more briefly, a *sequence*) of real numbers is a real-valued function defined on a set of integers  $\{n \mid n \geq k\}$ . We call the values of the function the *terms* of the sequence. We denote a sequence by listing its terms in order; thus,

$$\{s_n\}_k^\infty = \{s_k, s_{k+1}, \dots\}. \quad (4.1.1)$$

For example,

$$\begin{aligned} \left\{ \frac{1}{n^2 + 1} \right\}_0^\infty &= \left\{ 1, \frac{1}{2}, \frac{1}{5}, \dots, \frac{1}{n^2 + 1}, \dots \right\}, \\ \{(-1)^n\}_0^\infty &= \{1, -1, 1, \dots, (-1)^n, \dots\}, \end{aligned}$$

and

$$\left\{ \frac{1}{n-2} \right\}_3^\infty = \left\{ 1, \frac{1}{2}, \frac{1}{3}, \dots, \frac{1}{n-2}, \dots \right\}.$$

The real number  $s_n$  is the  $n$ th *term* of the sequence. Usually we are interested only in the terms of a sequence and the order in which they appear, but not in the particular value of  $k$  in (4.1.1). Therefore, we regard the sequences

$$\left\{ \frac{1}{n-2} \right\}_3^\infty \quad \text{and} \quad \left\{ \frac{1}{n} \right\}_1^\infty$$

as identical.

We will usually write  $\{s_n\}$  rather than  $\{s_n\}_k^\infty$ . In the absence of any indication to the contrary, we take  $k = 0$  unless  $s_n$  is given by a rule that is invalid for some nonnegative integer, in which case  $k$  is understood to be the smallest positive integer such that  $s_n$  is defined for all  $n \geq k$ . For example, if

$$s_n = \frac{1}{(n-1)(n-5)},$$

then  $k = 6$ .

The interesting questions about a sequence  $\{s_n\}$  concern the behavior of  $s_n$  for large  $n$ .

### Limit of a Sequence

**Definition 4.1.1** A sequence  $\{s_n\}$  *converges to a limit*  $s$  if for every  $\epsilon > 0$  there is an integer  $N$  such that

$$|s_n - s| < \epsilon \quad \text{if} \quad n \geq N. \quad (4.1.2)$$

In this case we say that  $\{s_n\}$  is *convergent* and write

$$\lim_{n \rightarrow \infty} s_n = s.$$

A sequence that does not converge *diverges*, or is *divergent* ■

As we saw in Section 2.1 when discussing limits of functions, Definition 4.1.1 is not changed by replacing (4.1.2) with

$$|s_n - s| < K\epsilon \quad \text{if } n \geq N,$$

where  $K$  is a positive constant.

**Example 4.1.1** If  $s_n = c$  for  $n \geq k$ , then  $|s_n - c| = 0$  for  $n \geq k$ , and  $\lim_{n \rightarrow \infty} s_n = c$ .

**Example 4.1.2** If

$$s_n = \left\{ \frac{2n + 1}{n + 1} \right\},$$

then  $\lim_{n \rightarrow \infty} s_n = 2$ , since

$$|s_n - 2| = \left| \frac{2n + 1}{n + 1} - \frac{2n + 2}{n + 1} \right| = \frac{1}{n + 1};$$

hence, if  $\epsilon > 0$ , then (4.1.2) holds with  $s = 2$  if  $N \geq 1/\epsilon$ . ■

Definition 4.1.1 does not require that there be an integer  $N$  such that (4.1.2) holds for all  $\epsilon$ ; rather, it requires that for each positive  $\epsilon$  there be an integer  $N$  that satisfies (4.1.2) for that particular  $\epsilon$ . Usually,  $N$  depends on  $\epsilon$  and must be increased if  $\epsilon$  is decreased. The constant sequences (Example 4.1.1) are essentially the only ones for which  $N$  does not depend on  $\epsilon$  (Exercise 4.1.5).

We say that the terms of a sequence  $\{s_n\}_k^\infty$  satisfy a given condition *for all*  $n$  if  $s_n$  satisfies the condition for all  $n \geq k$ , or *for large*  $n$  if there is an integer  $N > k$  such that  $s_n$  satisfies the condition whenever  $n \geq N$ . For example, the terms of  $\{1/n\}_1^\infty$  are positive for all  $n$ , while those of  $\{1 - 7/n\}_1^\infty$  are positive for large  $n$  (take  $N = 8$ ).

## Uniqueness of the Limit

**Theorem 4.1.2** *The limit of a convergent sequence is unique.*

**Proof** Suppose that

$$\lim_{n \rightarrow \infty} s_n = s \quad \text{and} \quad \lim_{n \rightarrow \infty} s_n = s'.$$

We must show that  $s = s'$ . Let  $\epsilon > 0$ . From Definition 4.1.1, there are integers  $N_1$  and  $N_2$  such that

$$|s_n - s| < \epsilon \quad \text{if } n \geq N_1$$

(because  $\lim_{n \rightarrow \infty} s_n = s$ ), and

$$|s_n - s'| < \epsilon \quad \text{if } n \geq N_2$$

(because  $\lim_{n \rightarrow \infty} s_n = s'$ ). These inequalities both hold if  $n \geq N = \max(N_1, N_2)$ , which implies that

$$\begin{aligned} |s - s'| &= |(s - s_N) + (s_N - s')| \\ &\leq |s - s_N| + |s_N - s'| < \epsilon + \epsilon = 2\epsilon. \end{aligned}$$

Since this inequality holds for every  $\epsilon > 0$  and  $|s - s'|$  is independent of  $\epsilon$ , we conclude that  $|s - s'| = 0$ ; that is,  $s = s'$ . ■

### Sequences Diverging to $\pm\infty$

We say that

$$\lim_{n \rightarrow \infty} s_n = \infty$$

if for any real number  $a$ ,  $s_n > a$  for large  $n$ . Similarly,

$$\lim_{n \rightarrow \infty} s_n = -\infty$$

if for any real number  $a$ ,  $s_n < a$  for large  $n$ . However, we do not regard  $\{s_n\}$  as convergent unless  $\lim_{n \rightarrow \infty} s_n$  is finite, as required by Definition 4.1.1. To emphasize this distinction, we say that  $\{s_n\}$  *diverges to*  $\infty$  ( $-\infty$ ) if  $\lim_{n \rightarrow \infty} s_n = \infty$  ( $-\infty$ ).

**Example 4.1.3** The sequence  $\{n/2 + 1/n\}$  diverges to  $\infty$ , since, if  $a$  is any real number, then

$$\frac{n}{2} + \frac{1}{n} > a \quad \text{if } n \geq 2a.$$

The sequence  $\{n - n^2\}$  diverges to  $-\infty$ , since, if  $a$  is any real number, then

$$-n^2 + n = -n(n - 1) < a \quad \text{if } n > 1 + \sqrt{|a|}.$$

Therefore, we write

$$\lim_{n \rightarrow \infty} \left( \frac{n}{2} + \frac{1}{n} \right) = \infty$$

and

$$\lim_{n \rightarrow \infty} (-n^2 + n) = -\infty.$$

The sequence  $\{(-1)^n n^3\}$  diverges, but not to  $-\infty$  or  $\infty$ .

### Bounded Sequences

**Definition 4.1.3** A sequence  $\{s_n\}$  is *bounded above* if there is a real number  $b$  such that

$$s_n \leq b \quad \text{for all } n,$$

*bounded below* if there is a real number  $a$  such that

$$s_n \geq a \quad \text{for all } n,$$

or *bounded* if there is a real number  $r$  such that

$$|s_n| \leq r \quad \text{for all } n.$$

**Example 4.1.4** If  $s_n = [1 + (-1)^n]n$ , then  $\{s_n\}$  is bounded below ( $s_n \geq 0$ ) but unbounded above, and  $\{-s_n\}$  is bounded above ( $-s_n \leq 0$ ) but unbounded below. If  $s_n = (-1)^n$ , then  $\{s_n\}$  is bounded. If  $s_n = (-1)^n n$ , then  $\{s_n\}$  is not bounded above or below.

**Theorem 4.1.4** *A convergent sequence is bounded.*

**Proof** By taking  $\epsilon = 1$  in (4.1.2), we see that if  $\lim_{n \rightarrow \infty} s_n = s$ , then there is an integer  $N$  such that

$$|s_n - s| < 1 \quad \text{if } n \geq N.$$

Therefore,

$$|s_n| = |(s_n - s) + s| \leq |s_n - s| + |s| < 1 + |s| \quad \text{if } n \geq N,$$

and

$$|s_n| \leq \max\{|s_0|, |s_1|, \dots, |s_{N-1}|, 1 + |s|\}$$

for all  $n$ , so  $\{s_n\}$  is bounded. ■

## Monotonic Sequences

**Definition 4.1.5** A sequence  $\{s_n\}$  is *nondecreasing* if  $s_n \geq s_{n-1}$  for all  $n$ , or *nonincreasing* if  $s_n \leq s_{n-1}$  for all  $n$ . A *monotonic sequence* is a sequence that is either nonincreasing or nondecreasing. If  $s_n > s_{n-1}$  for all  $n$ , then  $\{s_n\}$  is *increasing*, while if  $s_n < s_{n-1}$  for all  $n$ ,  $\{s_n\}$  is *decreasing*.

### Theorem 4.1.6

- (a) If  $\{s_n\}$  is nondecreasing, then  $\lim_{n \rightarrow \infty} s_n = \sup\{s_n\}$ .  
 (b) If  $\{s_n\}$  is nonincreasing, then  $\lim_{n \rightarrow \infty} s_n = \inf\{s_n\}$ .

**Proof** (a). Let  $\beta = \sup\{s_n\}$ . If  $\beta < \infty$ , Theorem 1.1.3 implies that if  $\epsilon > 0$  then

$$\beta - \epsilon < s_N \leq \beta$$

for some integer  $N$ . Since  $s_N \leq s_n \leq \beta$  if  $n \geq N$ , it follows that

$$\beta - \epsilon < s_n \leq \beta \quad \text{if } n \geq N.$$

This implies that  $|s_n - \beta| < \epsilon$  if  $n \geq N$ , so  $\lim_{n \rightarrow \infty} s_n = \beta$ , by Definition 4.1.1. If  $\beta = \infty$  and  $b$  is any real number, then  $s_N > b$  for some integer  $N$ . Then  $s_n > b$  for  $n \geq N$ , so  $\lim_{n \rightarrow \infty} s_n = \infty$ .

We leave the proof of (b) to you (Exercise 4.1.8) ■

**Example 4.1.5** If  $s_0 = 1$  and  $s_n = 1 - e^{-s_{n-1}}$ , then  $0 < s_n \leq 1$  for all  $n$ , by induction. Since

$$s_{n+1} - s_n = -(e^{-s_n} - e^{-s_{n-1}}) \quad \text{if } n \geq 1,$$

the mean value theorem (Theorem 2.3.11) implies that

$$s_{n+1} - s_n = e^{-t_n}(s_n - s_{n-1}) \quad \text{if } n \geq 1, \quad (4.1.3)$$

where  $t_n$  is between  $s_{n-1}$  and  $s_n$ . Since  $s_1 - s_0 = -1/e < 0$ , it follows by induction from (4.1.3) that  $s_{n+1} - s_n < 0$  for all  $n$ . Hence,  $\{s_n\}$  is bounded and decreasing, and therefore convergent.

### Sequences of Functional Values

The next theorem enables us to apply the theory of limits developed in Section 2.1 to some sequences. We leave the proof to you (Exercise 4.1.13).

**Theorem 4.1.7** *Let  $\lim_{x \rightarrow \infty} f(x) = L$ , where  $L$  is in the extended reals, and suppose that  $s_n = f(n)$  for large  $n$ . Then*

$$\lim_{n \rightarrow \infty} s_n = L.$$

**Example 4.1.6** Let

$$s_n = \frac{\log n}{n} \quad \text{and} \quad f(x) = \frac{\log x}{x}.$$

By L'Hospital's rule,

$$\lim_{x \rightarrow \infty} \frac{\log x}{x} = \lim_{x \rightarrow \infty} \frac{1/x}{1} = 0.$$

Hence,  $\lim_{n \rightarrow \infty} \log n/n = 0$ .

**Example 4.1.7** Let  $s_n = (1 + 1/n)^n$  and

$$f(x) = \left(1 + \frac{1}{x}\right)^x = e^{x \log(1+1/x)}.$$

By L'Hospital's rule,

$$\begin{aligned} \lim_{x \rightarrow \infty} x \log \left(1 + \frac{1}{x}\right) &= \lim_{x \rightarrow \infty} \frac{\log(1 + 1/x)}{1/x} \\ &= \lim_{x \rightarrow \infty} \frac{\frac{1}{x^2} \frac{1}{1 + 1/x}}{-1/x^2} = 1; \end{aligned}$$

hence,

$$\lim_{x \rightarrow \infty} \left(1 + \frac{1}{x}\right)^x = e^1 = e \quad \text{and} \quad \lim_{n \rightarrow \infty} \left(1 + \frac{1}{n}\right)^n = e.$$

The last equation is sometimes used to define  $e$ .



**Example 4.1.8** Suppose that  $s_n = \rho^n$  with  $\rho > 0$ , and let  $f(x) = \rho^x = e^{x \log \rho}$ . Since

$$\lim_{x \rightarrow \infty} e^{x \log \rho} = \begin{cases} 0, & \text{if } \log \rho < 0 \quad (0 < \rho < 1), \\ 1, & \text{if } \log \rho = 0 \quad (\rho = 1), \\ \infty, & \text{if } \log \rho > 0 \quad (\rho > 1), \end{cases}$$

it follows that

$$\lim_{n \rightarrow \infty} \rho^n = \begin{cases} 0, & 0 < \rho < 1, \\ 1, & \rho = 1, \\ \infty, & \rho > 1. \end{cases}$$

Therefore,

$$\lim_{n \rightarrow \infty} r^n = \begin{cases} 0, & -1 < r < 1, \\ 1, & r = 1, \\ \infty, & r > 1, \end{cases}$$

a result that we will use often.

### A Useful Limit Theorem

The next theorem enables us to investigate convergence of sequences by examining simpler sequences. It is analogous to Theorem 2.1.4.

**Theorem 4.1.8** *Let*

$$\lim_{n \rightarrow \infty} s_n = s \quad \text{and} \quad \lim_{n \rightarrow \infty} t_n = t, \quad (4.1.4)$$

where  $s$  and  $t$  are finite. Then

$$\lim_{n \rightarrow \infty} (cs_n) = cs \quad (4.1.5)$$

if  $c$  is a constant;

$$\lim_{n \rightarrow \infty} (s_n + t_n) = s + t, \quad (4.1.6)$$

$$\lim_{n \rightarrow \infty} (s_n - t_n) = s - t, \quad (4.1.7)$$

$$\lim_{n \rightarrow \infty} (s_n t_n) = st, \quad (4.1.8)$$

and

$$\lim_{n \rightarrow \infty} \frac{s_n}{t_n} = \frac{s}{t} \quad (4.1.9)$$

if  $t_n$  is nonzero for all  $n$  and  $t \neq 0$ .

**Proof** We prove (4.1.8) and (4.1.9) and leave the rest to you (Exercises 4.1.15 and 4.1.17). For (4.1.8), we write

$$s_n t_n - st = s_n t_n - st_n + st_n - st = (s_n - s)t_n + s(t_n - t);$$

hence,

$$|s_n t_n - st| \leq |s_n - s| |t_n| + |s| |t_n - t|. \quad (4.1.10)$$

Since  $\{t_n\}$  converges, it is bounded (Theorem 4.1.4). Therefore, there is a number  $R$  such that  $|t_n| \leq R$  for all  $n$ , and (4.1.10) implies that

$$|s_n t_n - st| \leq R|s_n - s| + |s| |t_n - t|. \quad (4.1.11)$$

From (4.1.4), if  $\epsilon > 0$  there are integers  $N_1$  and  $N_2$  such that

$$|s_n - s| < \epsilon \quad \text{if } n \geq N_1 \quad (4.1.12)$$

and

$$|t_n - t| < \epsilon \quad \text{if } n \geq N_2. \quad (4.1.13)$$

If  $N = \max(N_1, N_2)$ , then (4.1.12) and (4.1.13) both hold when  $n \geq N$ , and (4.1.11) implies that

$$|s_n t_n - st| \leq (R + |s|)\epsilon \quad \text{if } n \geq N.$$

This proves (4.1.8).

Now consider (4.1.9) in the special case where  $s_n = 1$  for all  $n$  and  $t \neq 0$ ; thus, we want to show that

$$\lim_{n \rightarrow \infty} \frac{1}{t_n} = \frac{1}{t}.$$

First, observe that since  $\lim_{n \rightarrow \infty} t_n = t \neq 0$ , there is an integer  $M$  such that  $|t_n| \geq |t|/2$  if  $n \geq M$ . To see this, we apply Definition 4.1.1 with  $\epsilon = |t|/2$ ; thus, there is an integer  $M$  such that  $|t_n - t| < |t|/2$  if  $n \geq M$ . Therefore,

$$|t_n| = |t + (t_n - t)| \geq ||t| - |t_n - t|| \geq \frac{|t|}{2} \quad \text{if } n \geq M.$$

If  $\epsilon > 0$ , choose  $N_0$  so that  $|t_n - t| < \epsilon$  if  $n \geq N_0$ , and let  $N = \max(N_0, M)$ . Then

$$\left| \frac{1}{t_n} - \frac{1}{t} \right| = \frac{|t - t_n|}{|t_n| |t|} \leq \frac{2\epsilon}{|t|^2} \quad \text{if } n \geq N;$$

hence,  $\lim_{n \rightarrow \infty} 1/t_n = 1/t$ . Now we obtain (4.1.9) in the general case from (4.1.8) with  $\{t_n\}$  replaced by  $\{1/t_n\}$ . ■

**Example 4.1.9** To determine the limit of the sequence defined by

$$s_n = \frac{1}{n} \sin \frac{n\pi}{4} + \frac{2(1 + 3/n)}{1 + 1/n},$$

we apply the applicable parts of Theorem 4.1.8 as follows:

$$\begin{aligned} \lim_{n \rightarrow \infty} s_n &= \lim_{n \rightarrow \infty} \frac{1}{n} \sin \frac{n\pi}{4} + \frac{2 \left[ \lim_{n \rightarrow \infty} 1 + 3 \lim_{n \rightarrow \infty} (1/n) \right]}{\lim_{n \rightarrow \infty} 1 + \lim_{n \rightarrow \infty} (1/n)} \\ &= 0 + \frac{2(1 + 3 \cdot 0)}{1 + 0} = 2. \end{aligned}$$

**Example 4.1.10** Sometimes preliminary manipulations are necessary before applying Theorem 4.1.8. For example,

$$\begin{aligned} \lim_{n \rightarrow \infty} \frac{(n/2) + \log n}{3n + 4\sqrt{n}} &= \lim_{n \rightarrow \infty} \frac{1/2 + (\log n)/n}{3 + 4n^{-1/2}} \\ &= \frac{\lim_{n \rightarrow \infty} 1/2 + \lim_{n \rightarrow \infty} (\log n)/n}{\lim_{n \rightarrow \infty} 3 + 4 \lim_{n \rightarrow \infty} n^{-1/2}} \\ &= \frac{1/2 + 0}{3 + 0} \quad (\text{see Example 4.1.6}) \\ &= \frac{1}{6}. \end{aligned}$$

**Example 4.1.11** Suppose that  $-1 < r < 1$  and

$$s_0 = 1, \quad s_1 = 1 + r, \quad s_2 = 1 + r + r^2, \dots, \quad s_n = 1 + r + \dots + r^n.$$

Since

$$s_n - rs_n = (1 + r + \dots + r^n) - (r + r^2 + \dots + r^{n+1}) = 1 - r^{n+1},$$

it follows that

$$s_n = \frac{1 - r^{n+1}}{1 - r}. \quad (4.1.14)$$

From Example 4.1.8,  $\lim_{n \rightarrow \infty} r^{n+1} = 0$ , so (4.1.14) and Theorem 4.1.8 yield

$$\lim_{n \rightarrow \infty} (1 + r + \dots + r^n) = \frac{1}{1 - r} \quad \text{if } -1 < r < 1. \quad \blacksquare$$

Equations (4.1.5)–(4.1.8) are valid even if  $s$  and  $t$  are arbitrary extended reals, provided that their right sides are defined in the extended reals (Exercises 4.1.16, 4.1.18, and 4.1.21); (4.1.9) is valid if  $s/t$  is defined in the extended reals and  $t \neq 0$  (Exercise 4.1.22).

**Example 4.1.12** If  $-1 < r < 1$ , then

$$\lim_{n \rightarrow \infty} \frac{r^n}{n!} = \frac{\lim_{n \rightarrow \infty} r^n}{\lim_{n \rightarrow \infty} n!} = \frac{0}{\infty} = 0,$$

from (4.1.9) and Example 4.1.8. However, if  $r > 1$ , (4.1.9) and Example 4.1.8 yield

$$\lim_{n \rightarrow \infty} \frac{r^n}{n!} = \frac{\lim_{n \rightarrow \infty} r^n}{\lim_{n \rightarrow \infty} n!} = \frac{\infty}{\infty},$$

an indeterminate form. If  $r \leq -1$ , then  $\lim_{n \rightarrow \infty} r^n$  does not exist in the extended reals, so (4.1.9) is not applicable. Theorem 4.1.7 does not help either, since there is no elementary function  $f$  such that  $f(n) = r^n/n!$ . However, the following argument shows that

$$\lim_{n \rightarrow \infty} \frac{r^n}{n!} = 0, \quad -\infty < r < \infty. \quad (4.1.15)$$

There is an integer  $M$  such that

$$\frac{|r|}{n} < \frac{1}{2} \quad \text{if } n \geq M.$$

Let  $K = r^M/M!$ . Then

$$\frac{|r|^n}{n!} \leq K \frac{|r|}{M+1} \frac{|r|}{M+2} \cdots \frac{|r|}{n} < K \left(\frac{1}{2}\right)^{n-M}, \quad n > M.$$

Given  $\epsilon > 0$ , choose  $N \geq M$  so that  $K/2^{N-M} < \epsilon$ . Then  $|r|^n/n! < \epsilon$  if  $n \geq N$ , which verifies (4.1.15).

## Limits Superior and Inferior

Requiring a sequence to converge may be unnecessarily restrictive in some situations. Often, useful results can be obtained from assumptions on the *limit superior* and *limit inferior* of a sequence, which we consider next.

### Theorem 4.1.9

(a) If  $\{s_n\}$  is bounded above and does not diverge to  $-\infty$ , then there is a unique real number  $\bar{s}$  such that, if  $\epsilon > 0$ ,

$$s_n < \bar{s} + \epsilon \quad \text{for large } n \quad (4.1.16)$$

and

$$s_n > \bar{s} - \epsilon \quad \text{for infinitely many } n. \quad (4.1.17)$$

(b) If  $\{s_n\}$  is bounded below and does not diverge to  $\infty$ , then there is a unique real number  $\underline{s}$  such that, if  $\epsilon > 0$ ,

$$s_n > \underline{s} - \epsilon \quad \text{for large } n \quad (4.1.18)$$

and

$$s_n < \underline{s} + \epsilon \quad \text{for infinitely many } n. \quad (4.1.19)$$

**Proof** We will prove (a) and leave the proof of (b) to you (Exercise 4.1.23). Since  $\{s_n\}$  is bounded above, there is a number  $\beta$  such that  $s_n < \beta$  for all  $n$ . Since  $\{s_n\}$  does not diverge to  $-\infty$ , there is a number  $\alpha$  such that  $s_n > \alpha$  for infinitely many  $n$ . If we define

$$M_k = \sup\{s_k, s_{k+1}, \dots, s_{k+r}, \dots\},$$

then  $\alpha \leq M_k \leq \beta$ , so  $\{M_k\}$  is bounded. Since  $\{M_k\}$  is nonincreasing (why?), it converges, by Theorem 4.1.6. Let

$$\bar{s} = \lim_{k \rightarrow \infty} M_k. \quad (4.1.20)$$

If  $\epsilon > 0$ , then  $M_k < \bar{s} + \epsilon$  for large  $k$ , and since  $s_n \leq M_k$  for  $n \geq k$ ,  $\bar{s}$  satisfies (4.1.16).

If (4.1.17) were false for some positive  $\epsilon$ , there would be an integer  $K$  such that

$$s_n \leq \bar{s} - \epsilon \quad \text{if } n \geq K.$$

However, this implies that

$$M_k \leq \bar{s} - \epsilon \quad \text{if } k \geq K,$$

which contradicts (4.1.20). Therefore,  $\bar{s}$  has the stated properties.

Now we must show that  $\bar{s}$  is the only real number with the stated properties. If  $t < \bar{s}$ , the inequality

$$s_n < t + \frac{\bar{s} - t}{2} = \bar{s} - \frac{\bar{s} - t}{2}$$

cannot hold for all large  $n$ , because this would contradict (4.1.17) with  $\epsilon = (\bar{s} - t)/2$ . If  $\bar{s} < t$ , the inequality

$$s_n > t - \frac{t - \bar{s}}{2} = \bar{s} + \frac{t - \bar{s}}{2}$$

cannot hold for infinitely many  $n$ , because this would contradict (4.1.16) with  $\epsilon = (t - \bar{s})/2$ . Therefore,  $\bar{s}$  is the only real number with the stated properties. ■

**Definition 4.1.10** The numbers  $\bar{s}$  and  $\underline{s}$  defined in Theorem 4.1.9 are called the *limit superior* and *limit inferior*, respectively, of  $\{s_n\}$ , and denoted by

$$\bar{s} = \overline{\lim}_{n \rightarrow \infty} s_n \quad \text{and} \quad \underline{s} = \underline{\lim}_{n \rightarrow \infty} s_n.$$

We also define

$$\begin{aligned} \overline{\lim}_{n \rightarrow \infty} s_n &= \infty && \text{if } \{s_n\} \text{ is not bounded above,} \\ \overline{\lim}_{n \rightarrow \infty} s_n &= -\infty && \text{if } \lim_{n \rightarrow \infty} s_n = -\infty, \\ \underline{\lim}_{n \rightarrow \infty} s_n &= -\infty && \text{if } \{s_n\} \text{ is not bounded below,} \end{aligned}$$

and

$$\underline{\lim}_{n \rightarrow \infty} s_n = \infty \quad \text{if } \lim_{n \rightarrow \infty} s_n = \infty.$$

**Theorem 4.1.11** Every sequence  $\{s_n\}$  of real numbers has a unique limit superior,  $\bar{s}$ , and a unique limit inferior,  $\underline{s}$ , in the extended reals, and

$$\underline{s} \leq \bar{s}. \quad (4.1.21)$$

**Proof** The existence and uniqueness of  $\bar{s}$  and  $\underline{s}$  follow from Theorem 4.1.9 and Definition 4.1.10. If  $\bar{s}$  and  $\underline{s}$  are both finite, then (4.1.16) and (4.1.18) imply that

$$\underline{s} - \epsilon < \bar{s} + \epsilon$$

for every  $\epsilon > 0$ , which implies (4.1.21). If  $\underline{s} = -\infty$  or  $\bar{s} = \infty$ , then (4.1.21) is obvious. If  $\underline{s} = \infty$  or  $\bar{s} = -\infty$ , then (4.1.21) follows immediately from Definition 4.1.10. ■

### Example 4.1.13

$$\overline{\lim}_{n \rightarrow \infty} r^n = \begin{cases} \infty, & |r| > 1, \\ 1, & |r| = 1, \\ 0, & |r| < 1; \end{cases}$$

and

$$\underline{\lim}_{n \rightarrow \infty} r^n = \begin{cases} \infty, & r > 1, \\ 1, & r = 1, \\ 0, & |r| < 1, \\ -1, & r = -1, \\ -\infty, & r < -1. \end{cases}$$

Also,

$$\overline{\lim}_{n \rightarrow \infty} n^2 = \underline{\lim}_{n \rightarrow \infty} n^2 = \infty,$$

$$\overline{\lim}_{n \rightarrow \infty} (-1)^n \left(1 - \frac{1}{n}\right) = 1, \quad \underline{\lim}_{n \rightarrow \infty} (-1)^n \left(n - \frac{1}{n}\right) = -1,$$

and

$$\overline{\lim}_{n \rightarrow \infty} [1 + (-1)^n] n^2 = \infty, \quad \underline{\lim}_{n \rightarrow \infty} [1 + (-1)^n] n^2 = 0.$$

**Theorem 4.1.12** *If  $\{s_n\}$  is a sequence of real numbers, then*

$$\lim_{n \rightarrow \infty} s_n = s \tag{4.1.22}$$

*if and only if*

$$\overline{\lim}_{n \rightarrow \infty} s_n = \underline{\lim}_{n \rightarrow \infty} s_n = s. \tag{4.1.23}$$

**Proof** If  $s = \pm\infty$ , the equivalence of (4.1.22) and (4.1.23) follows immediately from their definitions. If  $\lim_{n \rightarrow \infty} s_n = s$  (finite), then Definition 4.1.1 implies that (4.1.16)–(4.1.19) hold with  $\bar{s}$  and  $\underline{s}$  replaced by  $s$ . Hence, (4.1.23) follows from the uniqueness of  $\bar{s}$  and  $\underline{s}$ . For the converse, suppose that  $\bar{s} = \underline{s}$  and let  $s$  denote their common value. Then (4.1.16) and (4.1.18) imply that

$$s - \epsilon < s_n < s + \epsilon$$

for large  $n$ , and (4.1.22) follows from Definition 4.1.1 and the uniqueness of  $\lim_{n \rightarrow \infty} s_n$  (Theorem 4.1.2). ■

**Cauchy's Convergence Criterion**

To determine from Definition 4.1.1 whether a sequence has a limit, it is necessary to guess what the limit is. (This is particularly difficult if the sequence diverges!) To use Theorem 4.1.12 for this purpose requires finding  $\bar{s}$  and  $\underline{s}$ . The following convergence criterion has neither of these defects.

**Theorem 4.1.13 (Cauchy's Convergence Criterion)** *A sequence  $\{s_n\}$  of real numbers converges if and only if, for every  $\epsilon > 0$ , there is an integer  $N$  such that*

$$|s_n - s_m| < \epsilon \quad \text{if } m, n \geq N. \quad (4.1.24)$$

**Proof** Suppose that  $\lim_{n \rightarrow \infty} s_n = s$  and  $\epsilon > 0$ . By Definition 4.1.1, there is an integer  $N$  such that

$$|s_r - s| < \frac{\epsilon}{2} \quad \text{if } r \geq N.$$

Therefore,

$$|s_n - s_m| = |(s_n - s) + (s - s_m)| \leq |s_n - s| + |s - s_m| < \epsilon \quad \text{if } n, m \geq N.$$

Therefore, the stated condition is necessary for convergence of  $\{s_n\}$ . To see that it is sufficient, we first observe that it implies that  $\{s_n\}$  is bounded (Exercise 4.1.27), so  $\bar{s}$  and  $\underline{s}$  are finite (Theorem 4.1.9). Now suppose that  $\epsilon > 0$  and  $N$  satisfies (4.1.24). From (4.1.16) and (4.1.17),

$$|s_n - \bar{s}| < \epsilon, \quad (4.1.25)$$

for some integer  $n > N$  and, from (4.1.18) and (4.1.19),

$$|s_m - \underline{s}| < \epsilon \quad (4.1.26)$$

for some integer  $m > N$ . Since

$$\begin{aligned} |\bar{s} - \underline{s}| &= |(\bar{s} - s_n) + (s_n - s_m) + (s_m - \underline{s})| \\ &\leq |\bar{s} - s_n| + |s_n - s_m| + |s_m - \underline{s}|, \end{aligned}$$

(4.1.24)–(4.1.26) imply that

$$|\bar{s} - \underline{s}| < 3\epsilon.$$

Since  $\epsilon$  is an arbitrary positive number, this implies that  $\bar{s} = \underline{s}$ , so  $\{s_n\}$  converges, by Theorem 4.1.12. ■

**Example 4.1.14** Suppose that

$$|f'(x)| \leq r < 1, \quad -\infty < x < \infty. \quad (4.1.27)$$

Show that the equation

$$x = f(x) \quad (4.1.28)$$

has a unique solution.

**Solution** To see that (4.1.28) cannot have more than one solution, suppose that  $x = f(x)$  and  $x' = f(x')$ . From (4.1.27) and the mean value theorem (Theorem 2.3.11),

$$x - x' = f'(c)(x - x')$$

for some  $c$  between  $x$  and  $x'$ . This and (4.1.27) imply that

$$|x - x'| \leq r|x - x'|.$$

Since  $r < 1$ ,  $x = x'$ .

We will now show that (4.1.28) has a solution. With  $x_0$  arbitrary, define

$$x_n = f(x_{n-1}), \quad n \geq 1. \quad (4.1.29)$$

We will show that  $\{x_n\}$  converges. From (4.1.29) and the mean value theorem,

$$x_{n+1} - x_n = f(x_n) - f(x_{n-1}) = f'(c_n)(x_n - x_{n-1}),$$

where  $c_n$  is between  $x_{n-1}$  and  $x_n$ . This and (4.1.27) imply that

$$|x_{n+1} - x_n| \leq r|x_n - x_{n-1}| \quad \text{if } n \geq 1. \quad (4.1.30)$$

The inequality

$$|x_{n+1} - x_n| \leq r^n|x_1 - x_0| \quad \text{if } n \geq 0, \quad (4.1.31)$$

follows by induction from (4.1.30). Now, if  $n > m$ ,

$$\begin{aligned} |x_n - x_m| &= |(x_n - x_{n-1}) + (x_{n-1} - x_{n-2}) + \cdots + (x_{m+1} - x_m)| \\ &\leq |x_n - x_{n-1}| + |x_{n-1} - x_{n-2}| + \cdots + |x_{m+1} - x_m|, \end{aligned}$$

and (4.1.31) yields

$$|x_n - x_m| \leq |x_1 - x_0| r^m (1 + r + \cdots + r^{n-m-1}). \quad (4.1.32)$$

In Example 4.1.11 we saw that the sequence  $\{s_k\}$  defined by

$$s_k = 1 + r + \cdots + r^k$$

converges to  $1/(1-r)$  if  $|r| < 1$ ; moreover, since we have assumed here that  $0 < r < 1$ ,  $\{s_k\}$  is nondecreasing, and therefore  $s_k < 1/(1-r)$  for all  $k$ . Therefore, (4.1.32) yields

$$|x_n - x_m| < \frac{|x_1 - x_0|}{1-r} r^m \quad \text{if } n > m.$$

Now it follows that

$$|x_n - x_m| < \frac{|x_1 - x_0|}{1-r} r^N \quad \text{if } n, m > N,$$

and, since  $\lim_{N \rightarrow \infty} r^N = 0$ ,  $\{x_n\}$  converges, by Theorem 4.1.13. If  $\hat{x} = \lim_{n \rightarrow \infty} x_n$ , then (4.1.29) and the continuity of  $f$  imply that  $\hat{x} = f(\hat{x})$ .



## 4.1 Exercises

1. Prove: If  $s_n \geq 0$  for  $n \geq k$  and  $\lim_{n \rightarrow \infty} s_n = s$ , then  $s \geq 0$ .
2. (a) Show that  $\lim_{n \rightarrow \infty} s_n = s$  (finite) if and only if  $\lim_{n \rightarrow \infty} |s_n - s| = 0$ .  
 (b) Suppose that  $|s_n - s| \leq t_n$  for large  $n$  and  $\lim_{n \rightarrow \infty} t_n = 0$ . Show that  $\lim_{n \rightarrow \infty} s_n = s$ .
3. Find  $\lim_{n \rightarrow \infty} s_n$ . Justify your answers from Definition 4.1.1.  
 (a)  $s_n = 2 + \frac{1}{n+1}$       (b)  $s_n = \frac{\alpha + n}{\beta + n}$       (c)  $s_n = \frac{1}{n} \sin \frac{n\pi}{4}$
4. Find  $\lim_{n \rightarrow \infty} s_n$ . Justify your answers from Definition 4.1.1.  
 (a)  $s_n = \frac{n}{2n + \sqrt{n+1}}$       (b)  $s_n = \frac{n^2 + 2n + 2}{n^2 + n}$   
 (c)  $s_n = \frac{\sin n}{\sqrt{n}}$       (d)  $s_n = \sqrt{n^2 + n} - n$
5. State necessary and sufficient conditions on a convergent sequence  $\{s_n\}$  such that the integer  $N$  in Definition 4.1.1 does not depend upon  $\epsilon$ .
6. Prove: If  $\lim_{n \rightarrow \infty} s_n = s$  then  $\lim_{n \rightarrow \infty} |s_n| = |s|$ .
7. Suppose that  $\lim_{n \rightarrow \infty} s_n = s$  (finite) and, for each  $\epsilon > 0$ ,  $|s_n - t_n| < \epsilon$  for large  $n$ . Show that  $\lim_{n \rightarrow \infty} t_n = s$ .
8. Complete the proof of Theorem 4.1.6.
9. Use Theorem 4.1.6 to show that  $\{s_n\}$  converges.  
 (a)  $s_n = \frac{\alpha + n}{\beta + n}$  ( $\beta > 0$ )      (b)  $s_n = \frac{n!}{n^n}$   
 (c)  $s_n = \frac{r^n}{1 + r^n}$  ( $r > 0$ )      (d)  $s_n = \frac{(2n)!}{2^{2n}(n!)^2}$
10. Let  $y = \tan^{-1}x$  be the solution of  $x = \tan y$  such that  $-\pi/2 < y < \pi/2$ . Prove: If  $x_0 > 0$  and  $x_{n+1} = \tan^{-1}x_n$  ( $n \geq 0$ ), then  $\{x_n\}$  converges.
11. Suppose that  $s_0$  and  $A$  are positive numbers. Let
 
$$s_{n+1} = \frac{1}{2} \left( s_n + \frac{A}{s_n} \right), \quad n \geq 0.$$
  - (a) Show that  $s_{n+1} \geq \sqrt{A}$  if  $n \geq 0$ .
  - (b) Show that  $s_{n+1} \leq s_n$  if  $n \geq 1$ .
  - (c) Show that  $s = \lim_{n \rightarrow \infty} s_n$  exists.
  - (d) Find  $s$ .
12. Prove: If  $\{s_n\}$  is unbounded and monotonic, then either  $\lim_{n \rightarrow \infty} s_n = \infty$  or  $\lim_{n \rightarrow \infty} s_n = -\infty$ .
13. Prove Theorem 4.1.7.

14. Use Theorem 4.1.7 to find  $\lim_{n \rightarrow \infty} s_n$ .

$$\begin{array}{ll} \text{(a)} s_n = \frac{\alpha + n}{\beta + n} \quad (\beta > 0) & \text{(b)} s_n = \cos \frac{1}{n} \\ \text{(c)} s_n = n \sin \frac{1}{n} & \text{(d)} s_n = \log n - n \\ \text{(e)} s_n = \log(n+1) - \log(n-1) \end{array}$$

15. Suppose that  $\lim_{n \rightarrow \infty} s_n = s$  (finite). Show that if  $c$  is a constant, then  $\lim_{n \rightarrow \infty} (cs_n) = cs$ .

16. Suppose that  $\lim_{n \rightarrow \infty} s_n = s$  where  $s = \pm\infty$ . Show that if  $c$  is a nonzero constant, then  $\lim_{n \rightarrow \infty} (cs_n) = cs$ .

17. Prove: If  $\lim_{n \rightarrow \infty} s_n = s$  and  $\lim_{n \rightarrow \infty} t_n = t$ , where  $s$  and  $t$  are finite, then

$$\lim_{n \rightarrow \infty} (s_n + t_n) = s + t \quad \text{and} \quad \lim_{n \rightarrow \infty} (s_n - t_n) = s - t.$$

18. Prove: If  $\lim_{n \rightarrow \infty} s_n = s$  and  $\lim_{n \rightarrow \infty} t_n = t$ , where  $s$  and  $t$  are in the extended reals, then

$$\lim_{n \rightarrow \infty} (s_n + t_n) = s + t$$

if  $s + t$  is defined.

19. Suppose that  $\lim_{n \rightarrow \infty} t_n = t$ , where  $0 < |t| < \infty$ , and let  $0 < \rho < 1$ . Show that there is an integer  $N$  such that  $t_n > \rho t$  for  $n \geq N$  if  $t > 0$ , or  $t_n < \rho t$  for  $n \geq N$  if  $t < 0$ . In either case,  $|t_n| > \rho|t|$  if  $n \geq N$ .

20. Prove: If

$$\lim_{n \rightarrow \infty} \frac{s_n - s}{s_n + s} = 0, \quad \text{then} \quad \lim_{n \rightarrow \infty} s_n = s.$$

HINT: Define  $t_n = (s_n - s)/(s_n + s)$  and solve for  $s_n$ .

21. Prove: if  $\lim_{n \rightarrow \infty} s_n = s$  and  $\lim_{n \rightarrow \infty} t_n = t$ , where  $s$  and  $t$  are in the extended reals, then

$$\lim_{n \rightarrow \infty} s_n t_n = st$$

provided that  $st$  is defined in the extended reals.

22. Prove: If  $\lim_{n \rightarrow \infty} s_n = s$  and  $\lim_{n \rightarrow \infty} t_n = t$ , then

$$\lim_{n \rightarrow \infty} \frac{s_n}{t_n} = \frac{s}{t} \tag{A}$$

if  $s/t$  is defined in the extended reals and  $t \neq 0$ . Give an example where  $s/t$  is defined in the extended plane, but (A) does not hold.

23. Prove Theorem 4.1.9(b).

24. Find  $\bar{s}$  and  $\underline{s}$ .

$$\begin{array}{ll} \text{(a)} s_n = [(-1)^n + 1]n^2 & \text{(b)} s_n = (1 - r^n) \sin \frac{n\pi}{2} \end{array}$$

$$(c) s_n = \frac{r^{2n}}{1+r^n} \quad (r \neq -1) \qquad (d) s_n = n^2 - n$$

$$(e) s_n = (-1)^n t_n \text{ where } \lim_{n \rightarrow \infty} t_n = t$$

25. Find  $\bar{s}$  and  $\underline{s}$ .

$$(a) s_n = (-1)^n \qquad (b) s_n = (-1)^n \left(2 + \frac{3}{n}\right)$$

$$(c) s_n = \frac{n + (-1)^n(2n+1)}{n} \qquad (d) s_n = \sin \frac{n\pi}{3}$$

26. Suppose that  $\lim_{n \rightarrow \infty} |s_n| = \gamma$  (finite). Show that  $\{s_n\}$  diverges unless  $\gamma = 0$  or the terms in  $\{s_n\}$  have the same sign for large  $n$ . HINT: Use Exercise 4.1.19.

27. Prove: The sequence  $\{s_n\}$  is bounded if, for some positive  $\epsilon$ , there is an integer  $N$  such that  $|s_n - s_m| < \epsilon$  whenever  $n, m \geq N$ .

In Exercises 4.1.28–4.1.31, assume that  $\bar{s}$ ,  $\underline{s}$  (or  $s$ ),  $\bar{t}$ , and  $\underline{t}$  are in the extended reals, and show that the given inequalities or equations hold whenever their right sides are defined (not indeterminate).

$$28. \quad (a) \overline{\lim}_{n \rightarrow \infty} (-s_n) = -\underline{s} \qquad (b) \underline{\lim}_{n \rightarrow \infty} (-s_n) = -\bar{s}$$

$$29. \quad (a) \overline{\lim}_{n \rightarrow \infty} (s_n + t_n) \leq \bar{s} + \bar{t} \qquad (b) \underline{\lim}_{n \rightarrow \infty} (s_n + t_n) \geq \underline{s} + \underline{t}$$

$$30. \quad (a) \text{ If } s_n \geq 0, t_n \geq 0, \text{ then (i) } \overline{\lim}_{n \rightarrow \infty} s_n t_n \leq \bar{s}\bar{t} \text{ and (ii) } \underline{\lim}_{n \rightarrow \infty} s_n t_n \geq \underline{s}\underline{t}.$$

$$(b) \text{ If } s_n \leq 0, t_n \geq 0, \text{ then (i) } \overline{\lim}_{n \rightarrow \infty} s_n t_n \leq \bar{s}\underline{t} \text{ and (ii) } \underline{\lim}_{n \rightarrow \infty} s_n t_n \geq \underline{s}\bar{t}.$$

$$31. \quad (a) \text{ If } \lim_{n \rightarrow \infty} s_n = s > 0 \text{ and } t_n \geq 0, \text{ then (i) } \overline{\lim}_{n \rightarrow \infty} s_n t_n = s\bar{t} \text{ and (ii) } \underline{\lim}_{n \rightarrow \infty} s_n t_n = s\underline{t}.$$

$$(b) \text{ If } \lim_{n \rightarrow \infty} s_n = s < 0 \text{ and } t_n \geq 0, \text{ then (i) } \overline{\lim}_{n \rightarrow \infty} s_n t_n = s\underline{t} \text{ and (ii) } \underline{\lim}_{n \rightarrow \infty} s_n t_n = s\bar{t}.$$

32. Suppose that  $\{s_n\}$  converges and has only finitely many distinct terms. Show that  $s_n$  is constant for large  $n$ .

33. Let  $s_0$  and  $s_1$  be arbitrary, and

$$s_{n+1} = \frac{s_n + s_{n-1}}{2}, \quad n \geq 1.$$

Use Cauchy's convergence criterion to show that  $\{s_n\}$  converges.

$$34. \text{ Let } t_n = \frac{s_1 + s_2 + \cdots + s_n}{n}, n \geq 1.$$

(a) Prove: If  $\lim_{n \rightarrow \infty} s_n = s$  then  $\lim_{n \rightarrow \infty} t_n = s$ .

(b) Give an example to show that  $\{t_n\}$  may converge even though  $\{s_n\}$  does not.

35. (a) Show that

$$\lim_{n \rightarrow \infty} \left(1 - \frac{\alpha}{1}\right) \left(1 - \frac{\alpha}{2}\right) \cdots \left(1 - \frac{\alpha}{n}\right) = 0, \quad \text{if } \alpha > 0.$$

HINT: Look at the logarithm of the absolute value of the product.

(b) Conclude from (a) that

$$\lim_{n \rightarrow \infty} \binom{q}{n} = 0 \quad \text{if } q > -1,$$

where  $\binom{q}{n}$  is the generalized binomial coefficient of Example 2.5.3.

## 4.2 EARLIER TOPICS REVISITED WITH SEQUENCES

In Chapter 2.3 we used  $\epsilon$ - $\delta$  definitions and arguments to develop the theory of limits, continuity, and differentiability; for example,  $f$  is continuous at  $x_0$  if for each  $\epsilon > 0$  there is a  $\delta > 0$  such that  $|f(x) - f(x_0)| < \epsilon$  when  $|x - x_0| < \delta$ . The same theory can be developed by methods based on sequences. Although we will not carry this out in detail, we will develop it enough to give some examples. First, we need another definition about sequences.

**Definition 4.2.1** A sequence  $\{t_k\}$  is a *subsequence* of a sequence  $\{s_n\}$  if

$$t_k = s_{n_k}, \quad k \geq 0,$$

where  $\{n_k\}$  is an increasing infinite sequence of integers in the domain of  $\{s_n\}$ . We denote the subsequence  $\{t_k\}$  by  $\{s_{n_k}\}$ . ■

Note that  $\{s_n\}$  is a subsequence of itself, as can be seen by taking  $n_k = k$ . All other subsequences of  $\{s_n\}$  are obtained by deleting terms from  $\{s_n\}$  and leaving those remaining in their original relative order.

**Example 4.2.1** If

$$\{s_n\} = \left\{ \frac{1}{n} \right\} = \left\{ 1, \frac{1}{2}, \frac{1}{3}, \dots, \frac{1}{n}, \dots \right\},$$

then letting  $n_k = 2k$  yields the subsequence

$$\{s_{2k}\} = \left\{ \frac{1}{2k} \right\} = \left\{ \frac{1}{2}, \frac{1}{4}, \dots, \frac{1}{2k}, \dots \right\},$$

and letting  $n_k = 2k + 1$  yields the subsequence

$$\{s_{2k+1}\} = \left\{ \frac{1}{2k+1} \right\} = \left\{ 1, \frac{1}{3}, \dots, \frac{1}{2k+1}, \dots \right\}. \quad \blacksquare$$

Since a subsequence  $\{s_{n_k}\}$  is again a sequence (with respect to  $k$ ), we may ask whether  $\{s_{n_k}\}$  converges.

**Example 4.2.2** The sequence  $\{s_n\}$  defined by

$$s_n = (-1)^n \left(1 + \frac{1}{n}\right)$$

does not converge, but  $\{s_n\}$  has subsequences that do. For example,

$$\{s_{2k}\} = \left\{1 + \frac{1}{2k}\right\} \quad \text{and} \quad \lim_{k \rightarrow \infty} s_{2k} = 1,$$

while

$$\{s_{2k+1}\} = \left\{-1 - \frac{1}{2k+1}\right\} \quad \text{and} \quad \lim_{k \rightarrow \infty} s_{2k+1} = -1.$$

It can be shown (Exercise 4.2.1) that a subsequence  $\{s_{n_k}\}$  of  $\{s_n\}$  converges to 1 if and only if  $n_k$  is even for  $k$  sufficiently large, or to  $-1$  if and only if  $n_k$  is odd for  $k$  sufficiently large. Otherwise,  $\{s_{n_k}\}$  diverges. ■

The sequence in this example has subsequences that converge to different limits. The next theorem shows that if a sequence converges to a finite limit or diverges to  $\pm\infty$ , then all its subsequences do also.

**Theorem 4.2.2** If

$$\lim_{n \rightarrow \infty} s_n = s \quad (-\infty \leq s \leq \infty), \quad (4.2.1)$$

then

$$\lim_{k \rightarrow \infty} s_{n_k} = s \quad (4.2.2)$$

for every subsequence  $\{s_{n_k}\}$  of  $\{s_n\}$ .

**Proof** We consider the case where  $s$  is finite and leave the rest to you (Exercise 4.2.4). If (4.2.1) holds and  $\epsilon > 0$ , there is an integer  $N$  such that

$$|s_n - s| < \epsilon \quad \text{if} \quad n \geq N.$$

Since  $\{n_k\}$  is an increasing sequence, there is an integer  $K$  such that  $n_k \geq N$  if  $k \geq K$ . Therefore,

$$|s_{n_k} - s| < \epsilon \quad \text{if} \quad k \geq K,$$

which implies (4.2.2). ■

**Theorem 4.2.3** If  $\{s_n\}$  is monotonic and has a subsequence  $\{s_{n_k}\}$  such that

$$\lim_{k \rightarrow \infty} s_{n_k} = s \quad (-\infty \leq s \leq \infty),$$

then

$$\lim_{n \rightarrow \infty} s_n = s.$$

**Proof** We consider the case where  $\{s_n\}$  is nondecreasing and leave the rest to you (Exercise 4.2.6). Since  $\{s_{n_k}\}$  is also nondecreasing in this case, it suffices to show that

$$\sup\{s_{n_k}\} = \sup\{s_n\} \quad (4.2.3)$$

and then apply Theorem 4.1.6(a). Since the set of terms of  $\{s_{n_k}\}$  is contained in the set of terms of  $\{s_n\}$ ,

$$\sup\{s_n\} \geq \sup\{s_{n_k}\}. \quad (4.2.4)$$

Since  $\{s_n\}$  is nondecreasing, there is for every  $n$  an integer  $n_k$  such that  $s_n \leq s_{n_k}$ . This implies that

$$\sup\{s_n\} \leq \sup\{s_{n_k}\}.$$

This and (4.2.4) imply (4.2.3). ■

### Limit Points in Terms of Sequences

In Section 1.3 we defined *limit point* in terms of neighborhoods:  $\bar{x}$  is a limit point of a set  $S$  if every neighborhood of  $\bar{x}$  contains points of  $S$  distinct from  $\bar{x}$ . The next theorem shows that an equivalent definition can be stated in terms of sequences.

**Theorem 4.2.4** *A point  $\bar{x}$  is a limit point of a set  $S$  if and only if there is a sequence  $\{x_n\}$  of points in  $S$  such that  $x_n \neq \bar{x}$  for  $n \geq 1$ , and*

$$\lim_{n \rightarrow \infty} x_n = \bar{x}.$$

**Proof** For sufficiency, suppose that the stated condition holds. Then, for each  $\epsilon > 0$ , there is an integer  $N$  such that  $0 < |x_n - \bar{x}| < \epsilon$  if  $n \geq N$ . Therefore, every  $\epsilon$ -neighborhood of  $\bar{x}$  contains infinitely many points of  $S$ . This means that  $\bar{x}$  is a limit point of  $S$ .

For necessity, let  $\bar{x}$  be a limit point of  $S$ . Then, for every integer  $n \geq 1$ , the interval  $(\bar{x} - 1/n, \bar{x} + 1/n)$  contains a point  $x_n$  ( $\neq \bar{x}$ ) in  $S$ . Since  $|x_m - \bar{x}| \leq 1/n$  if  $m \geq n$ ,  $\lim_{n \rightarrow \infty} x_n = \bar{x}$ . ■

We will use the next theorem to show that continuity can be defined in terms of sequences.

### Theorem 4.2.5

- (a) *If  $\{x_n\}$  is bounded, then  $\{x_n\}$  has a convergent subsequence.*  
 (b) *If  $\{x_n\}$  is unbounded above, then  $\{x_n\}$  has a subsequence  $\{x_{n_k}\}$  such that*

$$\lim_{k \rightarrow \infty} x_{n_k} = \infty.$$

- (c) *If  $\{x_n\}$  is unbounded below, then  $\{x_n\}$  has a subsequence  $\{x_{n_k}\}$  such that*

$$\lim_{k \rightarrow \infty} x_{n_k} = -\infty.$$

**Proof** We prove (a) and leave (b) and (c) to you (Exercise 4.2.7). Let  $S$  be the set of distinct numbers that occur as terms of  $\{x_n\}$ . (For example, if  $\{x_n\} = \{(-1)^n\}$ ,  $S = \{1, -1\}$ ; if  $\{x_n\} = \{1, \frac{1}{2}, 1, \frac{1}{3}, \dots, 1, \frac{1}{n}, \dots\}$ ,  $S = \{1, \frac{1}{2}, \dots, 1/n, \dots\}$ .) If  $S$  contains only finitely many points, then some  $\bar{x}$  in  $S$  occurs infinitely often in  $\{x_n\}$ ; that is,  $\{x_n\}$  has a subsequence  $\{x_{n_k}\}$  such that  $x_{n_k} = \bar{x}$  for all  $k$ . Then  $\lim_{k \rightarrow \infty} x_{n_k} = \bar{x}$ , and we are finished in this case.

If  $S$  is infinite, then, since  $S$  is bounded (by assumption), the Bolzano–Weierstrass theorem (Theorem 1.3.8) implies that  $S$  has a limit point  $\bar{x}$ . From Theorem 4.2.4, there is a sequence of points  $\{y_j\}$  in  $S$ , distinct from  $\bar{x}$ , such that

$$\lim_{j \rightarrow \infty} y_j = \bar{x}. \quad (4.2.5)$$

Although each  $y_j$  occurs as a term of  $\{x_n\}$ ,  $\{y_j\}$  is not necessarily a subsequence of  $\{x_n\}$ , because if we write

$$y_j = x_{n_j},$$

there is no reason to expect that  $\{n_j\}$  is an increasing sequence as required in Definition 4.2.1. However, it is always possible to pick a subsequence  $\{n_{j_k}\}$  of  $\{n_j\}$  that is increasing, and then the sequence  $\{y_{j_k}\} = \{x_{n_{j_k}}\}$  is a subsequence of both  $\{y_j\}$  and  $\{x_n\}$ . Because of (4.2.5) and Theorem 4.2.2 this subsequence converges to  $\bar{x}$ . ■

## Continuity in Terms of Sequences

We now show that continuity can be defined and studied in terms of sequences.

**Theorem 4.2.6** *Let  $f$  be defined on a closed interval  $[a, b]$  containing  $\bar{x}$ . Then  $f$  is continuous at  $\bar{x}$  (from the right if  $\bar{x} = a$ , from the left if  $\bar{x} = b$ ) if and only if*

$$\lim_{n \rightarrow \infty} f(x_n) = f(\bar{x}) \quad (4.2.6)$$

whenever  $\{x_n\}$  is a sequence of points in  $[a, b]$  such that

$$\lim_{n \rightarrow \infty} x_n = \bar{x}. \quad (4.2.7)$$

**Proof** Assume that  $a < \bar{x} < b$ ; only minor changes in the proof are needed if  $\bar{x} = a$  or  $\bar{x} = b$ . First, suppose that  $f$  is continuous at  $\bar{x}$  and  $\{x_n\}$  is a sequence of points in  $[a, b]$  satisfying (4.2.7). If  $\epsilon > 0$ , there is a  $\delta > 0$  such that

$$|f(x) - f(\bar{x})| < \epsilon \quad \text{if} \quad |x - \bar{x}| < \delta. \quad (4.2.8)$$

From (4.2.7), there is an integer  $N$  such that  $|x_n - \bar{x}| < \delta$  if  $n \geq N$ . This and (4.2.8) imply that  $|f(x_n) - f(\bar{x})| < \epsilon$  if  $n \geq N$ . This implies (4.2.6), which shows that the stated condition is necessary.

For sufficiency, suppose that  $f$  is discontinuous at  $\bar{x}$ . Then there is an  $\epsilon_0 > 0$  such that, for each positive integer  $n$ , there is a point  $x_n$  that satisfies the inequality

$$|x_n - \bar{x}| < \frac{1}{n}$$

while

$$|f(x_n) - f(\bar{x})| \geq \epsilon_0.$$

The sequence  $\{x_n\}$  therefore satisfies (4.2.7), but not (4.2.6). Hence, the stated condition cannot hold if  $f$  is discontinuous at  $\bar{x}$ . This proves sufficiency. ■

Armed with the theorems we have proved so far in this section, we could develop the theory of continuous functions by means of definitions and proofs based on sequences and subsequences. We give one example, a new proof of Theorem 2.2.8, and leave others for exercises.

**Theorem 4.2.7** *If  $f$  is continuous on a closed interval  $[a, b]$ , then  $f$  is bounded on  $[a, b]$ .*

**Proof** The proof is by contradiction. If  $f$  is not bounded on  $[a, b]$ , there is for each positive integer  $n$  a point  $x_n$  in  $[a, b]$  such that  $|f(x_n)| > n$ . This implies that

$$\lim_{n \rightarrow \infty} |f(x_n)| = \infty. \quad (4.2.9)$$

Since  $\{x_n\}$  is bounded,  $\{x_n\}$  has a convergent subsequence  $\{x_{n_k}\}$  (Theorem 4.2.5(a)). If

$$\bar{x} = \lim_{k \rightarrow \infty} x_{n_k},$$

then  $\bar{x}$  is a limit point of  $[a, b]$ , so  $\bar{x} \in [a, b]$ . If  $f$  is continuous on  $[a, b]$ , then

$$\lim_{k \rightarrow \infty} f(x_{n_k}) = f(\bar{x})$$

by Theorem 4.2.6, so

$$\lim_{k \rightarrow \infty} |f(x_{n_k})| = |f(\bar{x})|$$

(Exercise 4.1.6), which contradicts (4.2.9). Therefore,  $f$  cannot be both continuous and unbounded on  $[a, b]$  ■

## 4.2 Exercises

- Let  $s_n = (-1)^n(1 + 1/n)$ . Show that  $\lim_{k \rightarrow \infty} s_{n_k} = 1$  if and only if  $n_k$  is even for large  $k$ ,  $\lim_{k \rightarrow \infty} s_{n_k} = -1$  if and only if  $n_k$  is odd for large  $k$ , and  $\{s_{n_k}\}$  diverges otherwise.
- Find all numbers  $L$  in the extended reals that are limits of some subsequence of  $\{s_n\}$  and, for each such  $L$ , choose a subsequence  $\{s_{n_k}\}$  such that  $\lim_{k \rightarrow \infty} s_{n_k} = L$ .
 

<p>(a) <math>s_n = (-1)^n n</math></p> <p>(c) <math>s_n = \left(1 - \frac{1}{n^2}\right) \sin \frac{n\pi}{2}</math></p> <p>(e) <math>s_n = [(-1)^n + 1]n^2</math></p>	<p>(b) <math>s_n = \left(1 + \frac{1}{n}\right) \cos \frac{n\pi}{2}</math></p> <p>(d) <math>s_n = \frac{1}{n}</math></p> <p>(f) <math>s_n = \frac{n+1}{n+2} \left(\sin \frac{n\pi}{4} + \cos \frac{n\pi}{4}\right)</math></p>
---	---



3. Construct a sequence  $\{s_n\}$  with the following property, or show that none exists: for each positive integer  $m$ ,  $\{s_n\}$  has a subsequence converging to  $m$ .
4. Complete the proof of Theorem 4.2.2.
5. Prove: If  $\lim_{n \rightarrow \infty} s_n = s$  and  $\{s_n\}$  has a subsequence  $\{s_{n_k}\}$  such that  $(-1)^k s_{n_k} \geq 0$ , then  $s = 0$ .
6. Complete the proof of Theorem 4.2.3.
7. Prove Theorem 4.2.5(b) and (c).
8. Suppose that  $\{s_n\}$  is bounded and all convergent subsequences of  $\{s_n\}$  converge to the same limit. Show that  $\{s_n\}$  is convergent. Give an example showing that the conclusion need not hold if  $\{s_n\}$  is unbounded.
9. (a) Let  $f$  be defined on a deleted neighborhood  $N$  of  $\bar{x}$ . Show that

$$\lim_{x \rightarrow \bar{x}} f(x) = L$$

if and only if  $\lim_{n \rightarrow \infty} f(x_n) = L$  whenever  $\{x_n\}$  is a sequence of points in  $N$  such that  $\lim_{n \rightarrow \infty} x_n = \bar{x}$ . HINT: See the proof of Theorem 4.2.6.

- (b) State a result like (a) for one-sided limits.
10. Give a proof based on sequences for Theorem 2.2.9. HINT: Use Theorems 4.1.6, 4.2.2, 4.2.5, and 4.2.6.
11. Give a proof based on sequences for Theorem 2.2.12.
12. Suppose that  $f$  is defined on a deleted neighborhood  $N$  of  $\bar{x}$  and  $\{f(x_n)\}$  approaches a limit whenever  $\{x_n\}$  is a sequence of points in  $N$  and  $\lim_{n \rightarrow \infty} x_n = \bar{x}$ . Show that if  $\{x_n\}$  and  $\{y_n\}$  are two such sequences, then  $\lim_{n \rightarrow \infty} f(x_n) = \lim_{n \rightarrow \infty} f(y_n)$ . Infer from this and Exercise 4.2.9 that  $\lim_{x \rightarrow \bar{x}} f(x)$  exists.
13. Prove: If  $f$  is defined on a neighborhood  $N$  of  $\bar{x}$ , then  $f$  is differentiable at  $\bar{x}$  if and only if

$$\lim_{n \rightarrow \infty} \frac{f(x_n) - f(\bar{x})}{x_n - \bar{x}}$$

exists whenever  $\{x_n\}$  is a sequence of points in  $N$  such that  $x_n \neq \bar{x}$  and  $\lim_{n \rightarrow \infty} x_n = \bar{x}$ . HINT: Use Exercise 4.2.12.

### 4.3 INFINITE SERIES OF CONSTANTS

The theory of sequences developed in the last two sections can be combined with the familiar notion of a finite sum to produce the theory of infinite series. We begin the study of infinite series in this section.

**Definition 4.3.1** If  $\{a_n\}_k^\infty$  is an infinite sequence of real numbers, the symbol

$$\sum_{n=k}^{\infty} a_n$$

is an *infinite series*, and  $a_n$  is the  $n$ th term of the series. We say that  $\sum_{n=k}^{\infty} a_n$  converges to the sum  $A$ , and write

$$\sum_{n=k}^{\infty} a_n = A,$$

if the sequence  $\{A_n\}_k^{\infty}$  defined by

$$A_n = a_k + a_{k+1} + \cdots + a_n, \quad n \geq k,$$

converges to  $A$ . The finite sum  $A_n$  is the  $n$ th partial sum of  $\sum_{n=k}^{\infty} a_n$ . If  $\{A_n\}_k^{\infty}$  diverges, we say that  $\sum_{n=k}^{\infty} a_n$  diverges; in particular, if  $\lim_{n \rightarrow \infty} A_n = \infty$  or  $-\infty$ , we say that  $\sum_{n=k}^{\infty} a_n$  diverges to  $\infty$  or  $-\infty$ , and write

$$\sum_{n=k}^{\infty} a_n = \infty \quad \text{or} \quad \sum_{n=k}^{\infty} a_n = -\infty.$$

A divergent infinite series that does not diverge to  $\pm\infty$  is said to *oscillate*, or *be oscillatory*. ■

We will usually refer to infinite series more briefly as *series*.

**Example 4.3.1** Consider the series

$$\sum_{n=0}^{\infty} r^n, \quad -1 < r < 1.$$

Here  $a_n = r^n$  ( $n \geq 0$ ) and

$$A_n = 1 + r + r^2 + \cdots + r^n = \frac{1 - r^{n+1}}{1 - r}, \quad (4.3.1)$$

which converges to  $1/(1 - r)$  as  $n \rightarrow \infty$  (Example 4.1.11); thus, we write

$$\sum_{n=0}^{\infty} r^n = \frac{1}{1 - r}, \quad -1 < r < 1.$$

If  $|r| > 1$ , then (4.3.1) is still valid, but  $\sum_{n=0}^{\infty} r^n$  diverges; if  $r > 1$ , then

$$\sum_{n=0}^{\infty} r^n = \infty, \quad (4.3.2)$$

while if  $r < -1$ ,  $\sum_{n=0}^{\infty} r^n$  oscillates, since its partial sums alternate in sign and their magnitudes become arbitrarily large for large  $n$ . If  $r = -1$ , then  $A_{2m+1} = 0$  and  $A_{2m} = 1$  for  $m \geq 0$ , while if  $r = 1$ ,  $A_n = n + 1$ ; in both cases the series diverges, and (4.3.2) holds if  $r = 1$ . ■

The series  $\sum_{n=0}^{\infty} r^n$  is called the *geometric series with ratio  $r$* . It occurs in many applications.

An infinite series can be viewed as a generalization of a finite sum

$$A = \sum_{n=k}^N a_n = a_k + a_{k+1} + \cdots + a_N$$

by thinking of the finite sequence  $\{a_k, a_{k+1}, \dots, a_N\}$  as being extended to an infinite sequence  $\{a_n\}_k^{\infty}$  with  $a_n = 0$  for  $n > N$ . Then the partial sums of  $\sum_{n=k}^{\infty} a_n$  are

$$A_n = a_k + a_{k+1} + \cdots + a_n, \quad k \leq n < N,$$

and

$$A_n = A, \quad n \geq N;$$

that is, the terms of  $\{A_n\}_k^{\infty}$  equal the finite sum  $A$  for  $n \geq N$ . Therefore,  $\lim_{n \rightarrow \infty} A_n = A$ .

The next two theorems can be proved by applying Theorems 4.1.2 and 4.1.8 to the partial sums of the series in question (Exercises 4.3.1 and 4.3.2).

**Theorem 4.3.2** *The sum of a convergent series is unique.*

**Theorem 4.3.3** *Let*

$$\sum_{n=k}^{\infty} a_n = A \quad \text{and} \quad \sum_{n=k}^{\infty} b_n = B,$$

where  $A$  and  $B$  are finite. Then

$$\sum_{n=k}^{\infty} (c a_n) = c A$$

if  $c$  is a constant,

$$\sum_{n=k}^{\infty} (a_n + b_n) = A + B,$$

and

$$\sum_{n=k}^{\infty} (a_n - b_n) = A - B.$$

*These relations also hold if one or both of  $A$  and  $B$  is infinite, provided that the right sides are not indeterminate.*

Dropping finitely many terms from a series does not alter convergence or divergence, although it does change the sum of a convergent series if the terms dropped have a nonzero sum. For example, suppose that we drop the first  $k$  terms of a series  $\sum_{n=0}^{\infty} a_n$ , and consider the new series  $\sum_{n=k}^{\infty} a_n$ . Denote the partial sums of the two series by

$$A_n = a_0 + a_1 + \cdots + a_n, \quad n \geq 0,$$

and

$$A'_n = a_k + a_{k+1} + \cdots + a_n, \quad n \geq k.$$

Since

$$A_n = (a_0 + a_1 + \cdots + a_{k-1}) + A'_n, \quad n \geq k,$$

it follows that  $A = \lim_{n \rightarrow \infty} A_n$  exists (in the extended reals) if and only if  $A' = \lim_{n \rightarrow \infty} A'_n$  does, and in this case

$$A = (a_0 + a_1 + \cdots + a_{k-1}) + A'.$$

An important principle follows from this.

**Lemma 4.3.4** *Suppose that for  $n$  sufficiently large (that is, for  $n \geq$  some integer  $N$ ) the terms of  $\sum_{n=k}^{\infty} a_n$  satisfy some condition that implies convergence of an infinite series. Then  $\sum_{n=k}^{\infty} a_n$  converges. Similarly, suppose that for  $n$  sufficiently large the terms  $\sum_{n=k}^{\infty} a_n$  satisfy some condition that implies divergence of an infinite series. Then  $\sum_{n=k}^{\infty} a_n$  diverges.*

**Example 4.3.2** Consider the alternating series test, which we will establish later as a special case of a more general test:

*The series  $\sum_{n=k}^{\infty} a_n$  converges if  $(-1)^n a_n > 0$ ,  $|a_{n+1}| < |a_n|$ , and  $\lim_{n \rightarrow \infty} a_n = 0$ .*

The terms of

$$\sum_{n=1}^{\infty} \frac{16 + (-2)^n}{n2^n}$$

do not satisfy these conditions for all  $n \geq 1$ , but they do satisfy them for sufficiently large  $n$ . Hence, the series converges, by Lemma 4.3.4. ■

We will soon give several conditions concerning convergence of a series  $\sum_{n=k}^{\infty} a_n$  with nonnegative terms. According to Lemma 4.3.4, these results apply to series that have at most finitely many negative terms, as long as  $a_n$  is nonnegative and satisfies the conditions for  $n$  sufficiently large.

When we are interested only in whether  $\sum_{n=k}^{\infty} a_n$  converges or diverges and not in its sum, we will simply say “ $\sum a_n$  converges” or “ $\sum a_n$  diverges.” Lemma 4.3.4 justifies this convention, subject to the understanding that  $\sum a_n$  stands for  $\sum_{n=k}^{\infty} a_n$ , where  $k$  is an integer such that  $a_n$  is defined for  $n \geq k$ . (For example,

$$\sum \frac{1}{(n-6)^2} \quad \text{stands for} \quad \sum_{n=k}^{\infty} \frac{1}{(n-6)^2},$$

where  $k \geq 7$ .) We write  $\sum a_n = \infty$  ( $-\infty$ ) if  $\sum a_n$  diverges to  $\infty$  ( $-\infty$ ). Finally, let us agree that

$$\sum_{n=k}^{\infty} a_n \quad \text{and} \quad \sum_{n=k-j}^{\infty} a_{n+j}$$

(where we obtain the second expression by shifting the index in the first) both represent the same series.

**Cauchy's Convergence Criterion for Series**

The Cauchy convergence criterion for sequences (Theorem 4.1.13) yields a useful criterion for convergence of series.

**Theorem 4.3.5 (Cauchy's Convergence Criterion for Series)** *A series  $\sum a_n$  converges if and only if for every  $\epsilon > 0$  there is an integer  $N$  such that*

$$|a_n + a_{n+1} + \cdots + a_m| < \epsilon \quad \text{if } m \geq n \geq N. \quad (4.3.3)$$

**Proof** In terms of the partial sums  $\{A_n\}$  of  $\sum a_n$ ,

$$a_n + a_{n+1} + \cdots + a_m = A_m - A_{n-1}.$$

Therefore, (4.3.3) can be written as

$$|A_m - A_{n-1}| < \epsilon \quad \text{if } m \geq n \geq N.$$

Since  $\sum a_n$  converges if and only if  $\{A_n\}$  converges, Theorem 4.1.13 implies the conclusion. ■

Intuitively, Theorem 4.3.5 means that  $\sum a_n$  converges if and only if arbitrarily long sums

$$a_n + a_{n+1} + \cdots + a_m, \quad m \geq n,$$

can be made as small as we please by picking  $n$  large enough.

**Example 4.3.3** Consider the geometric series  $\sum r^n$  of Example 4.3.1. If  $|r| \geq 1$ , then  $\{r^n\}$  does not converge to zero. Therefore  $\sum r^n$  diverges, as we saw in Example 4.3.1. If  $|r| < 1$  and  $m \geq n$ , then

$$\begin{aligned} |A_m - A_n| &= |r^{n+1} + r^{n+2} + \cdots + r^m| \\ &\leq |r|^{n+1}(1 + |r| + \cdots + |r|^{m-n-1}) \\ &= |r|^{n+1} \frac{1 - |r|^{m-n}}{1 - |r|} < \frac{|r|^{n+1}}{1 - |r|}. \end{aligned} \quad (4.3.4)$$

If  $\epsilon > 0$ , choose  $N$  so that

$$\frac{|r|^{N+1}}{1 - |r|} < \epsilon.$$

Then (4.3.4) implies that

$$|A_m - A_n| < \epsilon \quad \text{if } m \geq n \geq N.$$

Now Theorem 4.3.5 implies that  $\sum r^n$  converges if  $|r| < 1$ , as in Example 4.3.1. ■

Letting  $m = n$  in (4.3.3) yields the following important corollary of Theorem 4.3.5.

**Corollary 4.3.6** *If  $\sum a_n$  converges, then  $\lim_{n \rightarrow \infty} a_n = 0$ .*

It must be emphasized that Corollary 4.3.6 gives a *necessary* condition for convergence; that is,  $\sum a_n$  cannot converge unless  $\lim_{n \rightarrow \infty} a_n = 0$ . The condition is *not sufficient*;  $\sum a_n$  may diverge even if  $\lim_{n \rightarrow \infty} a_n = 0$ . We will see examples below.

We leave the proof of the following corollary of Theorem 4.3.5 to you (Exercise 4.3.5).

**Corollary 4.3.7** *If  $\sum a_n$  converges, then for each  $\epsilon > 0$  there is an integer  $K$  such that*

$$\left| \sum_{n=k}^{\infty} a_n \right| < \epsilon \quad \text{if } k \geq K;$$

that is,

$$\lim_{k \rightarrow \infty} \sum_{n=k}^{\infty} a_n = 0.$$

**Example 4.3.4** If  $|r| < 1$ , then

$$\left| \sum_{n=k}^{\infty} r^n \right| = \left| r^k \sum_{n=k}^{\infty} r^{n-k} \right| = \left| r^k \sum_{n=0}^{\infty} r^n \right| = \frac{|r|^k}{1-r}.$$

Therefore, if

$$\frac{|r|^K}{1-r} < \epsilon,$$

then

$$\left| \sum_{n=k}^{\infty} r^n \right| < \epsilon \quad \text{if } k \geq K,$$

which implies that  $\lim_{k \rightarrow \infty} \sum_{n=k}^{\infty} r^n = 0$ .

### Series of Nonnegative Terms

The theory of series  $\sum a_n$  with terms that are nonnegative for sufficiently large  $n$  is simpler than the general theory, since such a series either converges to a finite limit or diverges to  $\infty$ , as the next theorem shows.

**Theorem 4.3.8** *If  $a_n \geq 0$  for  $n \geq k$ , then  $\sum a_n$  converges if its partial sums are bounded, or diverges to  $\infty$  if they are not. These are the only possibilities and, in either case,*

$$\sum_{n=k}^{\infty} a_n = \sup \{A_n \mid n \geq k\},$$

where

$$A_n = a_k + a_{k+1} + \cdots + a_n, \quad n \geq k.$$

**Proof** Since  $A_n = A_{n-1} + a_n$  and  $a_n \geq 0$  ( $n \geq k$ ), the sequence  $\{A_n\}$  is nondecreasing, so the conclusion follows from Theorem 4.1.6(a) and Definition 4.3.1. ■

If  $a_n \geq 0$  for sufficiently large  $n$ , we will write  $\sum a_n < \infty$  if  $\sum a_n$  converges. This convention is based on Theorem 4.3.8, which says that such a series diverges only if  $\sum a_n = \infty$ . The convention does not apply to series with infinitely many negative terms, because such series may diverge without diverging to  $\infty$ ; for example, the series  $\sum_{n=0}^{\infty} (-1)^n$  oscillates, since its partial sums are alternately 1 and 0.

**Theorem 4.3.9 (The Comparison Test)** *Suppose that*

$$0 \leq a_n \leq b_n, \quad n \geq k. \quad (4.3.5)$$

Then

(a)  $\sum a_n < \infty$  if  $\sum b_n < \infty$ .

(b)  $\sum b_n = \infty$  if  $\sum a_n = \infty$ .

**Proof** (a) If

$$A_n = a_k + a_{k+1} + \cdots + a_n \quad \text{and} \quad B_n = b_k + b_{k+1} + \cdots + b_n, \quad n \geq k,$$

then, from (4.3.5),

$$A_n \leq B_n. \quad (4.3.6)$$

Now we use Theorem 4.3.8. If  $\sum b_n < \infty$ , then  $\{B_n\}$  is bounded above and (4.3.6) implies that  $\{A_n\}$  is also; therefore,  $\sum a_n < \infty$ . On the other hand, if  $\sum a_n = \infty$ , then  $\{A_n\}$  is unbounded above and (4.3.6) implies that  $\{B_n\}$  is also; therefore,  $\sum b_n = \infty$ .

We leave it to you to show that (a) implies (b). ■

**Example 4.3.5** Since

$$\frac{r^n}{n} < r^n, \quad n \geq 1,$$

and  $\sum r^n < \infty$  if  $0 < r < 1$ , the series  $\sum r^n/n$  converges if  $0 < r < 1$ , by the comparison test. Comparing these two series is inconclusive if  $r > 1$ , since it does not help to know that the terms of  $\sum r^n/n$  are smaller than those of the divergent series  $\sum r^n$ . If  $r < 0$ , the comparison test does not apply, since the series then have infinitely many negative terms.

**Example 4.3.6** Since

$$r^n < nr^n$$

and  $\sum r^n = \infty$  if  $r \geq 1$ , the comparison test implies that  $\sum nr^n = \infty$  if  $r \geq 1$ . Comparing these two series is inconclusive if  $0 < r < 1$ , since it does not help to know that the terms of  $\sum nr^n$  are larger than those of the convergent series  $\sum r^n$ . ■

The comparison test is useful if we have a collection of series with nonnegative terms and known convergence properties. We will now use the comparison test to build such a collection.

**Theorem 4.3.10 (The Integral Test)** *Let*

$$c_n = f(n), \quad n \geq k, \quad (4.3.7)$$

where  $f$  is positive, nonincreasing, and locally integrable on  $[k, \infty)$ . Then

$$\sum c_n < \infty \quad (4.3.8)$$

if and only if

$$\int_k^\infty f(x) dx < \infty. \quad (4.3.9)$$

**Proof** We first observe that (4.3.9) holds if and only if

$$\sum_{n=k}^\infty \int_n^{n+1} f(x) dx < \infty \quad (4.3.10)$$

(Exercise 4.3.9), so it is enough to show that (4.3.8) holds if and only if (4.3.10) does. From (4.3.7) and the assumption that  $f$  is nonincreasing,

$$c_{n+1} = f(n+1) \leq f(x) \leq f(n) = c_n, \quad n \leq x \leq n+1, \quad n \geq k.$$

Therefore,

$$c_{n+1} = \int_n^{n+1} c_{n+1} dx \leq \int_n^{n+1} f(x) dx \leq \int_n^{n+1} c_n dx = c_n, \quad n \geq k$$

(Theorem 3.3.4). From the first inequality and Theorem 4.3.9(a) with  $a_n = c_{n+1}$  and  $b_n = \int_n^{n+1} f(x) dx$ , (4.3.10) implies that  $\sum c_{n+1} < \infty$ , which is equivalent to (4.3.8). From the second inequality and Theorem 4.3.9(a) with  $a_n = \int_n^{n+1} f(x) dx$  and  $b_n = c_n$ , (4.3.8) implies (4.3.10). ■

**Example 4.3.7** The integral test implies that the series

$$\sum \frac{1}{n^p}, \quad \sum \frac{1}{n(\log n)^p}, \quad \text{and} \quad \sum \frac{1}{n \log n [\log(\log n)]^p}$$

converge if  $p > 1$  and diverge if  $0 < p \leq 1$ , because the same is true of the integrals

$$\int_a^\infty \frac{dx}{x^p}, \quad \int_a^\infty \frac{dx}{x(\log x)^p}, \quad \text{and} \quad \int_a^\infty \frac{dx}{x \log x [\log(\log x)]^p}$$

if  $a$  is sufficiently large. (See Example 3.4.3 and Exercise 3.4.10.) The three series diverge if  $p \leq 0$ : the first by Corollary 4.3.6, the second by comparison with the divergent series  $\sum 1/n$ , and the third by comparison with the divergent series  $\sum 1/(n \log n)$ . (The



divergence of the last two series for  $p \leq 0$  also follows from the integral test, but the divergence of the first does not. Why not?) These results can be generalized: If

$$L_0(x) = x \quad \text{and} \quad L_k(x) = \log[L_{k-1}(x)], \quad k \geq 1,$$

then

$$\sum \frac{1}{L_0(n)L_1(n)\cdots L_k(n)[L_{k+1}(n)]^p}$$

converges if and only if  $p > 1$  (Exercise 4.3.11). ■

This example provides an infinite family of series with known convergence properties that can be used as standards for the comparison test.

Except for the series of Example 4.3.7, the integral test is of limited practical value, since convergence or divergence of most of the series to which it can be applied can be determined by simpler tests that do not require integration. However, the method used to prove the integral test is often useful for estimating the rate of convergence or divergence of a series. This idea is developed in Exercises 4.3.13 and 4.3.14.

**Example 4.3.8** The series

$$\sum_{n=1}^{\infty} \frac{1}{(n^2 + n)^q} \tag{4.3.11}$$

converges if  $q > 1/2$ , by comparison with the convergent series  $\sum 1/n^{2q}$ , since

$$\frac{1}{(n^2 + n)^q} < \frac{1}{n^{2q}}, \quad n \geq 1.$$

This comparison is inconclusive if  $q \leq 1/2$ , since then

$$\sum \frac{1}{n^{2q}} = \infty,$$

and it does not help to know that the terms of (4.3.11) are smaller than those of a divergent series. However, we can use the comparison test here, after a little trickery. We observe that

$$\sum_{n=k-1}^{\infty} \frac{1}{(n+1)^{2q}} = \sum_{n=k}^{\infty} \frac{1}{n^{2q}} = \infty, \quad q \leq 1/2,$$

and

$$\frac{1}{(n+1)^{2q}} < \frac{1}{(n^2 + n)^q}.$$

Therefore, the comparison test implies that

$$\sum \frac{1}{(n^2 + n)^q} = \infty, \quad q \leq 1/2. \quad \blacksquare$$

The next theorem is often applicable where the integral test is not. It does not require the kind of trickery that we used in Example 4.3.8.

**Theorem 4.3.11** Suppose that  $a_n \geq 0$  and  $b_n > 0$  for  $n \geq k$ . Then

$$(a) \quad \sum a_n < \infty \quad \text{if} \quad \sum b_n < \infty \quad \text{and} \quad \overline{\lim}_{n \rightarrow \infty} a_n/b_n < \infty.$$

$$(b) \quad \sum a_n = \infty \quad \text{if} \quad \sum b_n = \infty \quad \text{and} \quad \underline{\lim}_{n \rightarrow \infty} a_n/b_n > 0.$$

**Proof** (a) If  $\overline{\lim}_{n \rightarrow \infty} a_n/b_n < \infty$ , then  $\{a_n/b_n\}$  is bounded, so there is a constant  $M$  and an integer  $k$  such that

$$a_n \leq M b_n, \quad n \geq k.$$

Since  $\sum b_n < \infty$ , Theorem 4.3.3 implies that  $\sum (M b_n) < \infty$ . Now  $\sum a_n < \infty$ , by the comparison test.

(b) If  $\underline{\lim}_{n \rightarrow \infty} a_n/b_n > 0$ , there is a constant  $m$  and an integer  $k$  such that

$$a_n \geq m b_n, \quad n \geq k.$$

Since  $\sum b_n = \infty$ , Theorem 4.3.3 implies that  $\sum (m b_n) = \infty$ . Now  $\sum a_n = \infty$ , by the comparison test. ■

**Example 4.3.9** Let

$$\sum b_n = \sum \frac{1}{n^{p+q}} \quad \text{and} \quad \sum a_n = \sum \frac{2 + \sin n\pi/6}{(n+1)^p(n-1)^q}.$$

Then

$$\frac{a_n}{b_n} = \frac{2 + \sin n\pi/6}{(1 + 1/n)^p(1 - 1/n)^q},$$

so

$$\overline{\lim}_{n \rightarrow \infty} \frac{a_n}{b_n} = 3 \quad \text{and} \quad \underline{\lim}_{n \rightarrow \infty} \frac{a_n}{b_n} = 1.$$

Since  $\sum b_n < \infty$  if and only if  $p + q > 1$ , the same is true of  $\sum a_n$ , by Theorem 4.3.11. ■

The following corollary of Theorem 4.3.11 is often useful, although it does not apply to the series of Example 4.3.9.

**Corollary 4.3.12** Suppose that  $a_n \geq 0$  and  $b_n > 0$  for  $n \geq k$ , and

$$\lim_{n \rightarrow \infty} \frac{a_n}{b_n} = L,$$

where  $0 < L < \infty$ . Then  $\sum a_n$  and  $\sum b_n$  converge or diverge together.

**Example 4.3.10** With this corollary we can avoid the kind of trickery used in the second part of Example 4.3.8, since

$$\lim_{n \rightarrow \infty} \frac{1}{(n^2 + n)^q} \bigg/ \frac{1}{n^{2q}} = \lim_{n \rightarrow \infty} \frac{1}{(1 + 1/n)^q} = 1,$$

so

$$\sum \frac{1}{(n^2 + n)^q} \quad \text{and} \quad \sum \frac{1}{n^{2q}}$$

converge or diverge together.

### The Ratio Test

It is sometimes possible to determine whether a series with positive terms converges by comparing the ratios of successive terms with the corresponding ratios of a series known to converge or diverge.

**Theorem 4.3.13** *Suppose that  $a_n > 0$ ,  $b_n > 0$ , and*

$$\frac{a_{n+1}}{a_n} \leq \frac{b_{n+1}}{b_n}. \quad (4.3.12)$$

*Then*

(a)  $\sum a_n < \infty$  if  $\sum b_n < \infty$ .

(b)  $\sum b_n = \infty$  if  $\sum a_n = \infty$ .

**Proof** Rewriting (4.3.12) as

$$\frac{a_{n+1}}{b_{n+1}} \leq \frac{a_n}{b_n},$$

we see that  $\{a_n/b_n\}$  is nonincreasing. Therefore,  $\overline{\lim}_{n \rightarrow \infty} a_n/b_n < \infty$ , and Theorem 4.3.11 (a) implies (a).

To prove (b), suppose that  $\sum a_n = \infty$ . Since  $\{a_n/b_n\}$  is nonincreasing, there is a number  $\rho$  such that  $b_n \geq \rho a_n$  for large  $n$ . Since  $\sum(\rho a_n) = \infty$  if  $\sum a_n = \infty$ , Theorem 4.3.9 (b) (with  $a_n$  replaced by  $\rho a_n$ ) implies that  $\sum b_n = \infty$ . ■

We will use this theorem to obtain two other widely applicable tests: the ratio test and Raabe's test.

**Theorem 4.3.14 (The Ratio Test)** *Suppose that  $a_n > 0$  for  $n \geq k$ . Then*

(a)  $\sum a_n < \infty$  if  $\overline{\lim}_{n \rightarrow \infty} a_{n+1}/a_n < 1$ .

(b)  $\sum a_n = \infty$  if  $\underline{\lim}_{n \rightarrow \infty} a_{n+1}/a_n > 1$ .

*If*

$$\underline{\lim}_{n \rightarrow \infty} \frac{a_{n+1}}{a_n} \leq 1 \leq \overline{\lim}_{n \rightarrow \infty} \frac{a_{n+1}}{a_n}, \quad (4.3.13)$$

*then the test is inconclusive; that is,  $\sum a_n$  may converge or diverge.*

**Proof (a)** If

$$\overline{\lim}_{n \rightarrow \infty} \frac{a_{n+1}}{a_n} < 1,$$

there is a number  $r$  such that  $0 < r < 1$  and

$$\frac{a_{n+1}}{a_n} < r$$

for  $n$  sufficiently large. This can be rewritten as

$$\frac{a_{n+1}}{a_n} < \frac{r^{n+1}}{r^n}.$$

Since  $\sum r^n < \infty$ , Theorem 4.3.13(a) with  $b_n = r^n$  implies that  $\sum a_n < \infty$ .

(b) If

$$\underline{\lim}_{n \rightarrow \infty} \frac{a_{n+1}}{a_n} > 1,$$

there is a number  $r$  such that  $r > 1$  and

$$\frac{a_{n+1}}{a_n} > r$$

for  $n$  sufficiently large. This can be rewritten as

$$\frac{a_{n+1}}{a_n} > \frac{r^{n+1}}{r^n}.$$

Since  $\sum r^n = \infty$ , Theorem 4.3.13(b) with  $a_n = r^n$  implies that  $\sum b_n = \infty$ . ■

To see that no conclusion can be drawn if (4.3.13) holds, consider

$$\sum a_n = \sum \frac{1}{n^p}.$$

This series converges if  $p > 1$  or diverges if  $p \leq 1$ ; however,

$$\overline{\lim}_{n \rightarrow \infty} \frac{a_{n+1}}{a_n} = \underline{\lim}_{n \rightarrow \infty} \frac{a_{n+1}}{a_n} = 1$$

for every  $p$ .

**Example 4.3.11** If

$$\sum a_n = \sum \left(2 + \sin \frac{n\pi}{2}\right) r^n,$$

then

$$\frac{a_{n+1}}{a_n} = r \frac{2 + \sin \frac{(n+1)\pi}{2}}{2 + \sin \frac{n\pi}{2}}$$

which assumes the values  $3r/2$ ,  $2r/3$ ,  $r/2$ , and  $2r$ , each infinitely many times; hence,

$$\overline{\lim}_{n \rightarrow \infty} \frac{a_{n+1}}{a_n} = 2r \quad \text{and} \quad \underline{\lim}_{n \rightarrow \infty} \frac{a_{n+1}}{a_n} = \frac{r}{2}.$$

Therefore,  $\sum a_n$  converges if  $0 < r < 1/2$  and diverges if  $r > 2$ . The ratio test is inconclusive if  $1/2 \leq r \leq 2$ . ■

The following corollary of the ratio test is the familiar ratio test from calculus.

**Corollary 4.3.15** *Suppose that  $a_n > 0$  ( $n \geq k$ ) and*

$$\lim_{n \rightarrow \infty} \frac{a_{n+1}}{a_n} = L.$$

*Then*

(a)  $\sum a_n < \infty$  if  $L < 1$ .

(b)  $\sum a_n = \infty$  if  $L > 1$ .

*The test is inconclusive if  $L = 1$ .*

**Example 4.3.12** The series  $\sum a_n = \sum nr^{n-1}$  converges if  $0 < r < 1$  or diverges if  $r > 1$ , since

$$\frac{a_{n+1}}{a_n} = \frac{(n+1)r^n}{nr^{n-1}} = \left(1 + \frac{1}{n}\right)r,$$

so

$$\lim_{n \rightarrow \infty} \frac{a_{n+1}}{a_n} = r.$$

Corollary 4.3.15 is inconclusive if  $r = 1$ , but then Corollary 4.3.6 implies that the series diverges. ■

The ratio test does not imply that  $\sum a_n < \infty$  if merely

$$\frac{a_{n+1}}{a_n} < 1 \tag{4.3.14}$$

for large  $n$ , since this could occur with  $\lim_{n \rightarrow \infty} a_{n+1}/a_n = 1$ , in which case the test is inconclusive. However, the next theorem shows that  $\sum a_n < \infty$  if (4.3.14) is replaced by the stronger condition that

$$\frac{a_{n+1}}{a_n} \leq 1 - \frac{p}{n}$$

for some  $p > 1$  and large  $n$ . It also shows that  $\sum a_n = \infty$  if

$$\frac{a_{n+1}}{a_n} \geq 1 - \frac{q}{n}$$

for some  $q < 1$  and large  $n$ .

**Theorem 4.3.16 (Raabe's Test)** *Suppose that  $a_n > 0$  for large  $n$ . Let*

$$M = \overline{\lim}_{n \rightarrow \infty} n \left( \frac{a_{n+1}}{a_n} - 1 \right) \quad \text{and} \quad m = \underline{\lim}_{n \rightarrow \infty} n \left( \frac{a_{n+1}}{a_n} - 1 \right).$$

*Then*

(a)  $\sum a_n < \infty$  if  $M < -1$ .

(b)  $\sum a_n = \infty$  if  $m > -1$ .

*The test is inconclusive if  $m \leq -1 \leq M$ .*

**Proof (a)** We need the inequality

$$\frac{1}{(1+x)^p} > 1 - px, \quad x > 0, \quad p > 0. \quad (4.3.15)$$

This follows from Taylor's theorem (Theorem 2.5.4), which implies that

$$\frac{1}{(1+x)^p} = 1 - px + \frac{1}{2} \frac{p(p+1)}{(1+c)^{p+2}} x^2,$$

where  $0 < c < x$ . (Verify.) Since the last term is positive if  $p > 0$ , this implies (4.3.15).

Now suppose that  $M < -p < -1$ . Then there is an integer  $k$  such that

$$n \left( \frac{a_{n+1}}{a_n} - 1 \right) < -p, \quad n \geq k,$$

so

$$\frac{a_{n+1}}{a_n} < 1 - \frac{p}{n}, \quad n \geq k.$$

Hence,

$$\frac{a_{n+1}}{a_n} < \frac{1}{(1+1/n)^p}, \quad n \geq k,$$

as can be seen by letting  $x = 1/n$  in (4.3.15). From this,

$$\frac{a_{n+1}}{a_n} < \frac{1}{(n+1)^p} \bigg/ \frac{1}{n^p}, \quad n \geq k.$$

Since  $\sum 1/n^p < \infty$  if  $p > 1$ , Theorem 4.3.13(a) implies that  $\sum a_n < \infty$ .

**(b)** Here we need the inequality

$$(1-x)^q < 1 - qx, \quad 0 < x < 1, \quad 0 < q < 1. \quad (4.3.16)$$

This also follows from Taylor's theorem, which implies that

$$(1-x)^q = 1 - qx + q(q-1)(1-c)^{q-2} \frac{x^2}{2},$$

where  $0 < c < x$ .

Now suppose that  $-1 < -q < m$ . Then there is an integer  $k$  such that

$$n \left( \frac{a_{n+1}}{a_n} - 1 \right) > -q, \quad n \geq k,$$

so

$$\frac{a_{n+1}}{a_n} \geq 1 - \frac{q}{n}, \quad n \geq k.$$

If  $q \leq 0$ , then  $\sum a_n = \infty$ , by Corollary 4.3.6. Hence, we may assume that  $0 < q < 1$ , so the last inequality implies that

$$\frac{a_{n+1}}{a_n} > \left( 1 - \frac{1}{n} \right)^q, \quad n \geq k,$$

as can be seen by setting  $x = 1/n$  in (4.3.16). Hence,

$$\frac{a_{n+1}}{a_n} > \frac{1}{n^q} \bigg/ \frac{1}{(n-1)^q}, \quad n \geq k.$$

Since  $\sum 1/n^q = \infty$  if  $q < 1$ , Theorem 4.3.13(b) implies that  $\sum a_n = \infty$ . ■

**Example 4.3.13** If

$$\sum a_n = \sum \frac{n!}{\alpha(\alpha+1)(\alpha+2)\cdots(\alpha+n-1)}, \quad \alpha > 0,$$

then

$$\lim_{n \rightarrow \infty} \frac{a_{n+1}}{a_n} = \lim_{n \rightarrow \infty} \frac{n+1}{\alpha+n} = 1,$$

so the ratio test is inconclusive. However,

$$\begin{aligned} \lim_{n \rightarrow \infty} n \left( \frac{a_{n+1}}{a_n} - 1 \right) &= \lim_{n \rightarrow \infty} n \left( \frac{n+1}{\alpha+n} - 1 \right) \\ &= \lim_{n \rightarrow \infty} \frac{n(1-\alpha)}{\alpha+n} = 1-\alpha, \end{aligned}$$

so Raabe's test implies that  $\sum a_n < \infty$  if  $\alpha > 2$  and  $\sum a_n = \infty$  if  $0 < \alpha < 2$ . Raabe's test is inconclusive if  $\alpha = 2$ , but then the series becomes

$$\sum \frac{n!}{(n+1)!} = \sum \frac{1}{n+1},$$

which we know is divergent.

**Example 4.3.14** Consider the series  $\sum a_n$ , where

$$a_{2m} = \frac{(m!)^2}{\alpha(\alpha+1)\cdots(\alpha+m)\beta(\beta+1)\cdots(\beta+m)}$$

and

$$a_{2m+1} = \frac{(m!)^2(m+1)}{\alpha(\alpha+1)\cdots(\alpha+m)\beta(\beta+1)\cdots(\beta+m+1)},$$

with  $0 < \alpha < \beta$ . Since

$$2m \left( \frac{a_{2m+1}}{a_{2m}} - 1 \right) = 2m \left( \frac{m+1}{\beta+m+1} - 1 \right) = -\frac{2m\beta}{\beta+m+1}$$

and

$$(2m+1) \left( \frac{a_{2m+2}}{a_{2m+1}} - 1 \right) = (2m+1) \left( \frac{m+1}{\alpha+m+1} - 1 \right) = -\frac{(2m+1)\alpha}{\alpha+m+1},$$

we have

$$\overline{\lim}_{n \rightarrow \infty} n \left( \frac{a_{n+1}}{a_n} - 1 \right) = -2\alpha \quad \text{and} \quad \underline{\lim}_{n \rightarrow \infty} n \left( \frac{a_{n+1}}{a_n} - 1 \right) = -2\beta.$$

Raabe's test implies that  $\sum a_n < \infty$  if  $\alpha > 1/2$  and  $\sum a_n = \infty$  if  $\beta < 1/2$ . The test is inconclusive if  $0 < \alpha \leq 1/2 \leq \beta$ . ■

The next theorem, which will be useful when we study power series (Section 4.5), concludes our discussion of series with nonnegative terms.

**Theorem 4.3.17 (Cauchy's Root Test)** *If  $a_n \geq 0$  for  $n \geq k$ , then*

(a)  $\sum a_n < \infty$  if  $\overline{\lim}_{n \rightarrow \infty} a_n^{1/n} < 1$ .

(b)  $\sum a_n = \infty$  if  $\overline{\lim}_{n \rightarrow \infty} a_n^{1/n} > 1$ .

The test is inconclusive if  $\overline{\lim}_{n \rightarrow \infty} a_n^{1/n} = 1$ .

**Proof** (a) If  $\overline{\lim}_{n \rightarrow \infty} a_n^{1/n} < 1$ , there is an  $r$  such that  $0 < r < 1$  and  $a_n^{1/n} < r$  for large  $n$ . Therefore,  $a_n < r^n$  for large  $n$ . Since  $\sum r^n < \infty$ , the comparison test implies that  $\sum a_n < \infty$ .

(b) If  $\overline{\lim}_{n \rightarrow \infty} a_n^{1/n} > 1$ , then  $a_n^{1/n} > 1$  for infinitely many values of  $n$ , so  $\sum a_n = \infty$ , by Corollary 4.3.6. ■

**Example 4.3.15** Cauchy's root test is inconclusive if

$$\sum a_n = \sum \frac{1}{n^p},$$

because then

$$\overline{\lim}_{n \rightarrow \infty} a_n^{1/n} = \lim_{n \rightarrow \infty} \left( \frac{1}{n^p} \right)^{1/n} = \lim_{n \rightarrow \infty} \exp \left( -\frac{p}{n} \log n \right) = 1$$

for all  $p$ . However, we know from the integral test that  $\sum 1/n^p < \infty$  if  $p > 1$  and  $\sum 1/n^p = \infty$  if  $p \leq 1$ .

**Example 4.3.16** If

$$\sum a_n = \sum \left( 2 + \sin \frac{n\pi}{4} \right)^n r^n,$$

then

$$\overline{\lim}_{n \rightarrow \infty} a_n^{1/n} = \overline{\lim}_{n \rightarrow \infty} \left( 2 + \sin \frac{n\pi}{4} \right) r = 3r,$$

and so  $\sum a_n < \infty$  if  $r < 1/3$  and  $\sum a_n = \infty$  if  $r > 1/3$ . The test is inconclusive if  $r = 1/3$ , but then  $|a_{8m+2}| = 1$  for  $m \geq 0$ , so  $\sum a_n = \infty$ , by Corollary 4.3.6.

## Absolute and Conditional Convergence

We now drop the assumption that the terms of  $\sum a_n$  are nonnegative for large  $n$ . In this case,  $\sum a_n$  may converge in two quite different ways. The first is defined as follows.

**Definition 4.3.18** A series  $\sum a_n$  converges absolutely, or is absolutely convergent, if  $\sum |a_n| < \infty$ .



**Example 4.3.17** A convergent series  $\sum a_n$  of nonnegative terms is absolutely convergent, since  $\sum a_n$  and  $\sum |a_n|$  are the same. More generally, any convergent series whose terms are of the same sign for sufficiently large  $n$  converges absolutely (Exercise 4.3.22).

**Example 4.3.18** Consider the series

$$\sum \frac{\sin n\theta}{n^p}, \quad (4.3.17)$$

where  $\theta$  is arbitrary and  $p > 1$ . Since

$$\left| \frac{\sin n\theta}{n^p} \right| \leq \frac{1}{n^p}$$

and  $\sum 1/n^p < \infty$  if  $p > 1$ , the comparison test implies that

$$\sum \left| \frac{\sin n\theta}{n^p} \right| < \infty, \quad p > 1.$$

Therefore, (4.3.17) converges absolutely if  $p > 1$ .

**Example 4.3.19** If  $0 < p < 1$ , then the series

$$\sum \frac{(-1)^n}{n^p}$$

does not converge absolutely, since

$$\sum \left| \frac{(-1)^n}{n^p} \right| = \sum \frac{1}{n^p} = \infty.$$

However, the series converges, by the alternating series test, which we prove below. ■

Any test for convergence of a series with nonnegative terms can be used to test an arbitrary series  $\sum a_n$  for absolute convergence by applying it to  $\sum |a_n|$ . We used the comparison test this way in Examples 4.3.18 and 4.3.19.

**Example 4.3.20** To test the series

$$\sum a_n = \sum (-1)^n \frac{n!}{\alpha(\alpha+1)\cdots(\alpha+n-1)}, \quad \alpha > 0,$$

for absolute convergence, we apply Raabe's test to

$$\sum a_n = \sum \frac{n!}{\alpha(\alpha+1)\cdots(\alpha+n-1)}.$$

From Example 4.3.13,  $\sum |a_n| < \infty$  if  $\alpha > 2$  and  $\sum |a_n| = \infty$  if  $\alpha < 2$ . Therefore,  $\sum a_n$  converges absolutely if  $\alpha > 2$ , but not if  $\alpha < 2$ . Notice that this does not imply that  $\sum a_n$  diverges if  $\alpha < 2$ . ■

The proof of the next theorem is analogous to the proof of Theorem 3.4.9. We leave it to you (Exercise 4.3.24).

**Theorem 4.3.19** *If  $\sum a_n$  converges absolutely, then  $\sum a_n$  converges.*

For example, Theorem 4.3.19 implies that

$$\sum \frac{\sin n\theta}{n^p}$$

converges if  $p > 1$ , since it then converges absolutely (Example 4.3.18).

The converse of Theorem 4.3.19 is false; a series may converge without converging absolutely. We say then that the series converges *conditionally*, or is *conditionally convergent*; thus,  $\sum (-1)^n/n^p$  converges conditionally if  $0 < p \leq 1$ .

### Dirichlet's Test for Series

Except for Theorem 4.3.5 and Corollary 4.3.6, the convergence tests we have studied so far apply only to series whose terms have the same sign for large  $n$ . The following theorem does not require this. It is analogous to Dirichlet's test for improper integrals (Theorem 3.4.10).

**Theorem 4.3.20 (Dirichlet's Test for Series)** *The series  $\sum_{n=k}^{\infty} a_n b_n$  converges if  $\lim_{n \rightarrow \infty} a_n = 0$ ,*

$$\sum |a_{n+1} - a_n| < \infty, \quad (4.3.18)$$

and

$$|b_k + b_{k+1} + \cdots + b_n| \leq M, \quad n \geq k, \quad (4.3.19)$$

for some constant  $M$ .

**Proof** The proof is similar to the proof of Dirichlet's test for integrals. Define

$$B_n = b_k + b_{k+1} + \cdots + b_n, \quad n \geq k$$

and consider the partial sums of  $\sum_{n=k}^{\infty} a_n b_n$ :

$$S_n = a_k b_k + a_{k+1} b_{k+1} + \cdots + a_n b_n, \quad n \geq k. \quad (4.3.20)$$

By substituting

$$b_k = B_k \quad \text{and} \quad b_n = B_n - B_{n-1}, \quad n \geq k+1,$$

into (4.3.20), we obtain

$$S_n = a_k B_k + a_{k+1} (B_{k+1} - B_k) + \cdots + a_n (B_n - B_{n-1}),$$

which we rewrite as

$$S_n = (a_k - a_{k+1})B_k + (a_{k+1} - a_{k+2})B_{k+1} + \cdots + (a_{n-1} - a_n)B_{n-1} + a_n B_n. \quad (4.3.21)$$

(The procedure that led from (4.3.20) to (4.3.21) is called *summation by parts*. It is analogous to integration by parts.) Now (4.3.21) can be viewed as

$$S_n = T_{n-1} + a_n B_n, \quad (4.3.22)$$

where

$$T_{n-1} = (a_k - a_{k+1})B_k + (a_{k+1} - a_{k+2})B_{k+1} + \cdots + (a_{n-1} - a_n)B_{n-1};$$

that is,  $\{T_n\}$  is the sequence of partial sums of the series

$$\sum_{j=k}^{\infty} (a_j - a_{j+1})B_j. \quad (4.3.23)$$

Since

$$|(a_j - a_{j+1})B_j| \leq M|a_j - a_{j+1}|$$

from (4.3.19), the comparison test and (4.3.18) imply that the series (4.3.23) converges absolutely. Theorem 4.3.19 now implies that  $\{T_n\}$  converges. Let  $T = \lim_{n \rightarrow \infty} T_n$ . Since  $\{B_n\}$  is bounded and  $\lim_{n \rightarrow \infty} a_n = 0$ , we infer from (4.3.22) that

$$\lim_{n \rightarrow \infty} S_n = \lim_{n \rightarrow \infty} T_{n-1} + \lim_{n \rightarrow \infty} a_n B_n = T + 0 = T.$$

Therefore,  $\sum a_n b_n$  converges. ■

**Example 4.3.21** To apply Dirichlet's test to

$$\sum_{n=2}^{\infty} \frac{\sin n\theta}{n + (-1)^n}, \quad \theta \neq k\pi \quad (k = \text{integer}),$$

we take

$$a_n = \frac{1}{n + (-1)^n} \quad \text{and} \quad b_n = \sin n\theta.$$

Then  $\lim_{n \rightarrow \infty} a_n = 0$ , and

$$|a_{n+1} - a_n| < \frac{3}{n(n-1)}$$

(verify), so

$$\sum |a_{n+1} - a_n| < \infty.$$

Now

$$B_n = \sin 2\theta + \sin 3\theta + \cdots + \sin n\theta.$$

To show that  $\{B_n\}$  is bounded, we use the trigonometric identity

$$\sin r\theta = \frac{\cos\left(r - \frac{1}{2}\right)\theta - \cos\left(r + \frac{1}{2}\right)\theta}{2 \sin(\theta/2)}, \quad \theta \neq 2k\pi,$$

to write

$$\begin{aligned} B_n &= \frac{(\cos \frac{3}{2}\theta - \cos \frac{5}{2}\theta) + (\cos \frac{5}{2}\theta - \cos \frac{7}{2}\theta) + \cdots + (\cos (n - \frac{1}{2})\theta - \cos(n + \frac{1}{2})\theta)}{2 \sin(\theta/2)} \\ &= \frac{\cos \frac{3}{2}\theta - \cos(n + \frac{1}{2})\theta}{2 \sin(\theta/2)}, \end{aligned}$$

which implies that

$$|B_n| \leq \left| \frac{1}{\sin(\theta/2)} \right|, \quad n \geq 2.$$

Since  $\{a_n\}$  and  $\{b_n\}$  satisfy the hypotheses of Dirichlet's theorem,  $\sum a_n b_n$  converges. ■

Dirichlet's test takes a simpler form if  $\{a_n\}$  is nonincreasing, as follows.

**Corollary 4.3.21 (Abel's Test)** *The series  $\sum a_n b_n$  converges if  $a_{n+1} \leq a_n$  for  $n \geq k$ ,  $\lim_{n \rightarrow \infty} a_n = 0$ , and*

$$|b_k + b_{k+1} + \cdots + b_n| \leq M, \quad n \geq k,$$

for some constant  $M$ .

**Proof** If  $a_{n+1} \leq a_n$ , then

$$\sum_{n=k}^m |a_{n+1} - a_n| = \sum_{n=k}^m (a_n - a_{n+1}) = a_k - a_{m+1}.$$

Since  $\lim_{m \rightarrow \infty} a_{m+1} = 0$ , it follows that

$$\sum_{n=k}^{\infty} |a_{n+1} - a_n| = a_k < \infty.$$

Therefore, the hypotheses of Dirichlet's test are satisfied, so  $\sum a_n b_n$  converges. ■

**Example 4.3.22** The series

$$\sum \frac{\sin n\theta}{n^p},$$

which we know is convergent if  $p > 1$  (Example 4.3.18), also converges if  $0 < p \leq 1$ . This follows from Abel's test, with  $a_n = 1/n^p$  and  $b_n = \sin n\theta$  (see Example 4.3.21). ■

The alternating series test from calculus follows easily from Abel's test.

**Corollary 4.3.22 (Alternating Series Test)** *The series  $\sum (-1)^n a_n$  converges if  $0 \leq a_{n+1} \leq a_n$  and  $\lim_{n \rightarrow \infty} a_n = 0$ .*

**Proof** Let  $b_n = (-1)^n$ ; then  $\{|B_n|\}$  is a sequence of zeros and ones and therefore bounded. The conclusion now follows from Abel's test. ■

### Grouping Terms in a Series

The terms of a finite sum can be grouped by inserting parentheses arbitrarily. For example,

$$(1 + 7) + (6 + 5) + 4 = (1 + 7 + 6) + (5 + 4) = (1 + 7) + (6 + 5 + 4).$$

According to the next theorem, the same is true of an infinite series that converges or diverges to  $\pm\infty$ .

**Theorem 4.3.23** Suppose that  $\sum_{n=k}^{\infty} a_n = A$ , where  $-\infty \leq A \leq \infty$ . Let  $\{n_j\}_1^{\infty}$  be an increasing sequence of integers, with  $n_1 \geq k$ . Define

$$\begin{aligned} b_1 &= a_k + \cdots + a_{n_1}, \\ b_2 &= a_{n_1+1} + \cdots + a_{n_2}, \\ &\vdots \\ b_r &= a_{n_{r-1}+1} + \cdots + a_{n_r}. \end{aligned}$$

Then

$$\sum_{j=1}^{\infty} b_{n_j} = A.$$

**Proof** If  $T_r$  is the  $r$ th partial sum of  $\sum_{j=1}^{\infty} b_{n_j}$  and  $\{A_n\}$  is the  $n$ th partial sum of  $\sum_{s=k}^{\infty} a_s$ , then

$$\begin{aligned} T_r &= b_1 + b_2 + \cdots + b_r \\ &= (a_1 + \cdots + a_{n_1}) + (a_{n_1+1} + \cdots + a_{n_2}) + \cdots + (a_{n_{r-1}+1} + \cdots + a_{n_r}) \\ &= A_{n_r}. \end{aligned}$$

Thus,  $\{T_r\}$  is a subsequence of  $\{A_n\}$ , so  $\lim_{r \rightarrow \infty} T_r = \lim_{n \rightarrow \infty} A_n = A$  by Theorem 4.2.2. ■

**Example 4.3.23** If  $\sum_{n=0}^{\infty} (-1)^n a_n$  satisfies the hypotheses of the alternating series test and converges to the sum  $S$ , Theorem 4.3.23 enables us to write

$$S = \sum_{n=0}^k (-1)^n a_n + (-1)^{k+1} \sum_{j=1}^{\infty} (a_{k+2j-1} - a_{k+2j})$$

and

$$S = \sum_{n=0}^k (-1)^n a_n + (-1)^{k+1} \left[ a_{k+1} - \sum_{j=1}^{\infty} (a_{k+2j} - a_{k+2j-1}) \right].$$

Since  $0 \leq a_{n+1} \leq a_n$ , these two equations imply that  $S - S_k$  is between 0 and  $(-1)^{k-1} a_{k+1}$ .

**Example 4.3.24** Introducing parentheses in some divergent series can yield seemingly contradictory results. For example, it is tempting to write

$$\sum_{n=1}^{\infty} (-1)^{n+1} = (1 - 1) + (1 - 1) + \cdots = 0 + 0 + \cdots$$

and conclude that  $\sum_{n=1}^{\infty} (-1)^n = 0$ , but equally tempting to write

$$\begin{aligned} \sum_{n=1}^{\infty} (-1)^{n+1} &= 1 - (1 - 1) - (1 - 1) - \cdots \\ &= 1 - 0 - 0 - \cdots \end{aligned}$$

and conclude that  $\sum_{n=1}^{\infty} (-1)^{n+1} = 1$ . Of course, there is no contradiction here, since Theorem 4.3.23 does not apply to this series, and neither of these operations is legitimate.

### Rearrangement of Series

A finite sum is not changed by rearranging its terms; thus,

$$1 + 3 + 7 = 1 + 7 + 3 = 3 + 1 + 7 = 3 + 7 + 1 = 7 + 1 + 3 = 7 + 3 + 1.$$

This is not true of all infinite series. Let us say that  $\sum b_n$  is a *rearrangement* of  $\sum a_n$  if the two series have the same terms, written in possibly different orders. Since the partial sums of the two series may form entirely different sequences, there is no apparent reason to expect them to exhibit the same convergence properties, and in general they do not.

We are interested in what happens if we rearrange the terms of a convergent series. We will see that every rearrangement of an absolutely convergent series has the same sum, but that conditionally convergent series fail, spectacularly, to have this property.

**Theorem 4.3.24** *If  $\sum_{n=1}^{\infty} b_n$  is a rearrangement of an absolutely convergent series  $\sum_{n=1}^{\infty} a_n$ , then  $\sum_{n=1}^{\infty} b_n$  also converges absolutely, and to the same sum.*

**Proof** Let

$$\overline{A}_n = |a_1| + |a_2| + \cdots + |a_n| \quad \text{and} \quad \overline{B}_n = |b_1| + |b_2| + \cdots + |b_n|.$$

For each  $n \geq 1$ , there is an integer  $k_n$  such that  $b_1, b_2, \dots, b_n$  are included among  $a_1, a_2, \dots, a_{k_n}$ , so  $\overline{B}_n \leq \overline{A}_{k_n}$ . Since  $\{\overline{A}_n\}$  is bounded, so is  $\{\overline{B}_n\}$ , and therefore  $\sum |b_n| < \infty$  (Theorem 4.3.8).

Now let

$$\begin{aligned} A_n &= a_1 + a_2 + \cdots + a_n, & B_n &= b_1 + b_2 + \cdots + b_n, \\ A &= \sum_{n=1}^{\infty} a_n, & \text{and} & B = \sum_{n=1}^{\infty} b_n. \end{aligned}$$

We must show that  $A = B$ . Suppose that  $\epsilon > 0$ . From Cauchy's convergence criterion for series and the absolute convergence of  $\sum a_n$ , there is an integer  $N$  such that

$$|a_{N+1}| + |a_{N+2}| + \cdots + |a_{N+k}| < \epsilon, \quad k \geq 1.$$

Choose  $N_1$  so that  $a_1, a_2, \dots, a_N$  are included among  $b_1, b_2, \dots, b_{N_1}$ . If  $n \geq N_1$ , then  $A_n$  and  $B_n$  both include the terms  $a_1, a_2, \dots, a_N$ , which cancel on subtraction; thus,  $|A_n - B_n|$  is dominated by the sum of the absolute values of finitely many terms from  $\sum a_n$  with subscripts greater than  $N$ . Since every such sum is less than  $\epsilon$ ,

$$|A_n - B_n| < \epsilon \quad \text{if } n \geq N_1.$$

Therefore,  $\lim_{n \rightarrow \infty} (A_n - B_n) = 0$  and  $A = B$ .  $\blacksquare$

To investigate the consequences of rearranging a conditionally convergent series, we need the next theorem, which is itself important.

**Theorem 4.3.25** *If  $P = \{a_{n_i}\}_1^\infty$  and  $Q = \{a_{m_j}\}_1^\infty$  are respectively the subsequences of all positive and negative terms in a conditionally convergent series  $\sum a_n$ , then*

$$\sum_{i=1}^{\infty} a_{n_i} = \infty \quad \text{and} \quad \sum_{j=1}^{\infty} a_{m_j} = -\infty. \quad (4.3.24)$$

**Proof** If both series in (4.3.24) converge, then  $\sum a_n$  converges absolutely, while if one converges and the other diverges, then  $\sum a_n$  diverges to  $\infty$  or  $-\infty$ . Hence, both must diverge.  $\blacksquare$

The next theorem implies that a conditionally convergent series can be rearranged to produce a series that converges to any given number, diverges to  $\pm\infty$ , or oscillates.

**Theorem 4.3.26** *Suppose that  $\sum_{n=1}^{\infty} a_n$  is conditionally convergent and  $\mu$  and  $\nu$  are arbitrarily given in the extended reals, with  $\mu \leq \nu$ . Then the terms of  $\sum_{n=1}^{\infty} a_n$  can be rearranged to form a series  $\sum_{n=1}^{\infty} b_n$  with partial sums*

$$B_n = b_1 + b_2 + \cdots + b_n, \quad n \geq 1,$$

such that

$$\overline{\lim}_{n \rightarrow \infty} B_n = \nu \quad \text{and} \quad \underline{\lim}_{n \rightarrow \infty} B_n = \mu. \quad (4.3.25)$$

**Proof** We consider the case where  $\mu$  and  $\nu$  are finite and leave the other cases to you (Exercise 4.3.36). We may ignore any zero terms that occur in  $\sum_{n=1}^{\infty} a_n$ . For convenience, we denote the positive terms by  $P = \{\alpha_i\}_1^\infty$  and the negative terms by  $Q = \{-\beta_j\}_1^\infty$ . We construct the sequence

$$\{b_n\}_1^\infty = \{\alpha_1, \dots, \alpha_{m_1}, -\beta_1, \dots, -\beta_{n_1}, \alpha_{m_1+1}, \dots, \alpha_{m_2}, -\beta_{n_1+1}, \dots, -\beta_{n_2}, \dots\}, \quad (4.3.26)$$

with segments chosen alternately from  $P$  and  $Q$ . Let  $m_0 = n_0 = 0$ . If  $k \geq 1$ , let  $m_k$  and  $n_k$  be the smallest integers such that  $m_k > m_{k-1}$ ,  $n_k > n_{k-1}$ ,

$$\sum_{i=1}^{m_k} \alpha_i - \sum_{j=1}^{n_{k-1}} \beta_j \geq \nu, \quad \text{and} \quad \sum_{i=1}^{m_k} \alpha_i - \sum_{j=1}^{n_k} \beta_j \leq \mu.$$

Theorem 4.3.25 implies that this construction is possible: since  $\sum \alpha_i = \sum \beta_j = \infty$ , we can choose  $m_k$  and  $n_k$  so that

$$\sum_{i=m_{k-1}}^{m_k} \alpha_i \quad \text{and} \quad \sum_{j=n_{k-1}}^{n_k} \beta_j$$

are as large as we please, no matter how large  $m_{k-1}$  and  $n_{k-1}$  are (Exercise 4.3.23). Since  $m_k$  and  $n_k$  are the smallest integers with the specified properties,

$$\nu \leq B_{m_k+n_{k-1}} < \nu + \alpha_{m_k}, \quad k \geq 2, \quad (4.3.27)$$

and

$$\mu - \beta_{n_k} < B_{m_k+n_k} \leq \mu, \quad k \geq 2. \quad (4.3.28)$$

From (4.3.26),  $b_n < 0$  if  $m_k + n_{k-1} < n \leq m_k + n_k$ , so

$$B_{m_k+n_k} \leq B_n \leq B_{m_k+n_{k-1}}, \quad m_k + n_{k-1} \leq n \leq m_k + n_k, \quad (4.3.29)$$

while  $b_n > 0$  if  $m_k + n_k < n \leq m_{k+1} + n_k$ , so

$$B_{m_k+n_k} \leq B_n \leq B_{m_{k+1}+n_k}, \quad m_k + n_k \leq n \leq m_{k+1} + n_k. \quad (4.3.30)$$

Because of (4.3.27) and (4.3.28), (4.3.29) and (4.3.30) imply that

$$\mu - \beta_{n_k} < B_n < \nu + \alpha_{m_k}, \quad m_k + n_{k-1} \leq n \leq m_k + n_k, \quad (4.3.31)$$

and

$$\mu - \beta_{n_k} < B_n < \nu + \alpha_{m_{k+1}}, \quad m_k + n_k \leq n \leq m_{k+1} + n_k. \quad (4.3.32)$$

From the first inequality of (4.3.27),  $B_n \geq \nu$  for infinitely many values of  $n$ . However, since  $\lim_{i \rightarrow \infty} \alpha_i = 0$ , the second inequalities in (4.3.31) and (4.3.32) imply that if  $\epsilon > 0$  then  $B_n > \nu + \epsilon$  for only finitely many values of  $n$ . Therefore,  $\overline{\lim}_{n \rightarrow \infty} B_n = \nu$ . From the second inequality in (4.3.28),  $B_n \leq \mu$  for infinitely many values of  $n$ . However, since  $\lim_{j \rightarrow \infty} \beta_j = 0$ , the first inequalities in (4.3.31) and (4.3.32) imply that if  $\epsilon > 0$  then  $B_n < \mu - \epsilon$  for only finitely many values of  $n$ . Therefore,  $\underline{\lim}_{n \rightarrow \infty} B_n = \mu$ . ■

## Multiplication of Series

The product of two finite sums can be written as another finite sum: for example,

$$\begin{aligned} (a_0 + a_1 + a_2)(b_0 + b_1 + b_2) &= a_0b_0 + a_0b_1 + a_0b_2 \\ &\quad + a_1b_0 + a_1b_1 + a_1b_2 \\ &\quad + a_2b_0 + a_2b_1 + a_2b_2, \end{aligned}$$



where the sum on the right contains each product  $a_i b_j$  ( $i, j = 0, 1, 2$ ) exactly once. These products can be rearranged arbitrarily without changing their sum. The corresponding situation for series is more complicated.

Given two series

$$\sum_{n=0}^{\infty} a_n \quad \text{and} \quad \sum_{n=0}^{\infty} b_n$$

(because of applications in Section 4.5, it is convenient here to start the summation index at zero), we can arrange all possible products  $a_i b_j$  ( $i, j \geq 0$ ) in a two-dimensional array:

$$\begin{array}{ccccccc} a_0 b_0 & a_0 b_1 & a_0 b_2 & a_0 b_3 & \cdots & & \\ a_1 b_0 & a_1 b_1 & a_1 b_2 & a_1 b_3 & \cdots & & \\ a_2 b_0 & a_2 b_1 & a_2 b_2 & a_2 b_3 & \cdots & & \\ a_3 b_0 & a_3 b_1 & a_3 b_2 & a_3 b_3 & \cdots & & \\ \vdots & \vdots & \vdots & \vdots & & & \end{array} \quad (4.3.33)$$

where the subscript on  $a$  is constant in each row and the subscript on  $b$  is constant in each column. Any sensible definition of the product

$$\left( \sum_{n=0}^{\infty} a_n \right) \left( \sum_{n=0}^{\infty} b_n \right)$$

clearly must involve every product in this array exactly once; thus, we might define the product of the two series to be the series  $\sum_{n=0}^{\infty} p_n$ , where  $\{p_n\}$  is a sequence obtained by ordering the products in (4.3.33) according to some method that chooses every product exactly once. One way to do this is indicated by

$$\begin{array}{ccccccc} a_0 b_0 & \rightarrow & a_0 b_1 & & a_0 b_2 & \rightarrow & a_0 b_3 & \cdots \\ & & \downarrow & & \uparrow & & \downarrow & \\ a_1 b_0 & \leftarrow & a_1 b_1 & & a_1 b_2 & & a_1 b_3 & \cdots \\ & & \downarrow & & \uparrow & & \downarrow & \\ a_2 b_0 & \rightarrow & a_2 b_1 & \rightarrow & a_2 b_2 & & a_2 b_3 & \cdots \\ & & \downarrow & & \downarrow & & \downarrow & \\ a_3 b_0 & \leftarrow & a_3 b_1 & \leftarrow & a_3 b_2 & \leftarrow & a_3 b_3 & \cdots \\ & & \downarrow & & \downarrow & & \downarrow & \\ \vdots & & \vdots & & \vdots & & \vdots & \end{array} \quad (4.3.34)$$

and another by

$$\begin{array}{cccccc}
 a_0b_0 & \rightarrow & a_0b_1 & \rightarrow & a_0b_2 & \rightarrow & a_0b_3 & \rightarrow & a_0b_4 & \cdots \\
 & \swarrow & & \nearrow & & \swarrow & & \nearrow & & \\
 a_1b_0 & & a_1b_1 & & a_1b_2 & & a_1b_3 & & \cdots & \\
 \downarrow & \nearrow & & \swarrow & & \nearrow & & & & \\
 a_2b_0 & & a_2b_1 & & a_2b_2 & & a_2b_3 & & \cdots & \\
 & \swarrow & & \nearrow & & \swarrow & & \nearrow & & \\
 a_3b_0 & & a_3b_1 & & a_3b_2 & & a_3b_3 & & \cdots & \\
 \downarrow & \nearrow & & & & & & & & \\
 a_4b_0 & & \vdots & & \vdots & & \vdots & & & 
 \end{array} \tag{4.3.35}$$

There are infinitely many others, and to each corresponds a series that we might consider to be the product of the given series. This raises a question: If

$$\sum_{n=0}^{\infty} a_n = A \quad \text{and} \quad \sum_{n=0}^{\infty} b_n = B$$

where  $A$  and  $B$  are finite, does every product series  $\sum_{n=0}^{\infty} p_n$  constructed by ordering the products in (4.3.33) converge to  $AB$ ?

The next theorem tells us when the answer is yes.

**Theorem 4.3.27** *Let*

$$\sum_{n=0}^{\infty} a_n = A \quad \text{and} \quad \sum_{n=0}^{\infty} b_n = B,$$

where  $A$  and  $B$  are finite, and at least one term of each series is nonzero. Then  $\sum_{n=0}^{\infty} p_n = AB$  for every sequence  $\{p_n\}$  obtained by ordering the products in (4.3.33) if and only if  $\sum a_n$  and  $\sum b_n$  converge absolutely. Moreover, in this case,  $\sum p_n$  converges absolutely.

**Proof** First, let  $\{p_n\}$  be the sequence obtained by arranging the products  $\{a_i b_j\}$  according to the scheme indicated in (4.3.34), and define

$$\begin{aligned}
 A_n &= a_0 + a_1 + \cdots + a_n, & \bar{A}_n &= |a_0| + |a_1| + \cdots + |a_n|, \\
 B_n &= b_0 + b_1 + \cdots + b_n, & \bar{B}_n &= |b_0| + |b_1| + \cdots + |b_n|, \\
 P_n &= p_0 + p_1 + \cdots + p_n, & \bar{P}_n &= |p_0| + |p_1| + \cdots + |p_n|.
 \end{aligned}$$

From (4.3.34), we see that

$$P_0 = A_0 B_0, \quad P_3 = A_1 B_1, \quad P_8 = A_2 B_2,$$

and, in general,

$$P_{(m+1)^2-1} = A_m B_m. \tag{4.3.36}$$

Similarly,

$$\overline{P}_{(m+1)^2-1} = \overline{A}_m \overline{B}_m. \quad (4.3.37)$$

If  $\sum |a_n| < \infty$  and  $\sum |b_n| < \infty$ , then  $\{\overline{A}_m \overline{B}_m\}$  is bounded and, since  $\overline{P}_m \leq \overline{P}_{(m+1)^2-1}$ , (4.3.37) implies that  $\{\overline{P}_m\}$  is bounded. Therefore,  $\sum |p_n| < \infty$ , so  $\sum p_n$  converges. Now

$$\begin{aligned} \sum_{n=0}^{\infty} p_n &= \lim_{n \rightarrow \infty} P_n && \text{(by definition)} \\ &= \lim_{m \rightarrow \infty} P_{(m+1)^2-1} && \text{(by Theorem 4.2.2)} \\ &= \lim_{m \rightarrow \infty} A_m B_m && \text{(from (4.3.36))} \\ &= \left( \lim_{m \rightarrow \infty} A_m \right) \left( \lim_{m \rightarrow \infty} B_m \right) && \text{(by Theorem 4.1.8)} \\ &= AB. \end{aligned}$$

Since any other ordering of the products in (4.3.33) produces a rearrangement of the absolutely convergent series  $\sum_{n=0}^{\infty} p_n$ , Theorem 4.3.24 implies that  $\sum |q_n| < \infty$  for every such ordering and that  $\sum_{n=0}^{\infty} q_n = AB$ . This shows that the stated condition is sufficient.

For necessity, again let  $\sum_{n=0}^{\infty} p_n$  be obtained from the ordering indicated in (4.3.34), and suppose that  $\sum_{n=0}^{\infty} p_n$  and all its rearrangements converge to  $AB$ . Then  $\sum p_n$  must converge absolutely, by Theorem 4.3.26. Therefore,  $\{\overline{P}_{m^2-1}\}$  is bounded, and (4.3.37) implies that  $\{\overline{A}_m\}$  and  $\{\overline{B}_m\}$  are bounded. (Here we need the assumption that neither  $\sum a_n$  nor  $\sum b_n$  consists entirely of zeros. Why?) Therefore,  $\sum |a_n| < \infty$  and  $\sum |b_n| < \infty$ . ■

The following definition of the product of two series is due to Cauchy. We will see the importance of this definition in Section 4.5.

**Definition 4.3.28** The *Cauchy product* of  $\sum_{n=0}^{\infty} a_n$  and  $\sum_{n=0}^{\infty} b_n$  is  $\sum_{n=0}^{\infty} c_n$ , where

$$c_n = a_0 b_n + a_1 b_{n-1} + \cdots + a_{n-1} b_1 + a_n b_0. \quad (4.3.38)$$

Thus,  $c_n$  is the sum of all products  $a_i b_j$ , where  $i \geq 0$ ,  $j \geq 0$ , and  $i + j = n$ ; thus,

$$c_n = \sum_{r=0}^n a_r b_{n-r} = \sum_{r=0}^n b_r a_{n-r}. \quad (4.3.39) \quad \blacksquare$$

Henceforth,  $(\sum_{n=0}^{\infty} a_n) (\sum_{n=0}^{\infty} b_n)$  should be interpreted as the Cauchy product. Notice that

$$\left( \sum_{n=0}^{\infty} a_n \right) \left( \sum_{n=0}^{\infty} b_n \right) = \left( \sum_{n=0}^{\infty} b_n \right) \left( \sum_{n=0}^{\infty} a_n \right),$$

and that the Cauchy product of two series is defined even if one or both diverge. In the case where both converge, it is natural to inquire about the relationship between the product of their sums and the sum of the Cauchy product. Theorem 4.3.27 yields a partial answer to this question, as follows.

**Theorem 4.3.29** If  $\sum_{n=0}^{\infty} a_n$  and  $\sum_{n=0}^{\infty} b_n$  converge absolutely to sums  $A$  and  $B$ , then the Cauchy product of  $\sum_{n=0}^{\infty} a_n$  and  $\sum_{n=0}^{\infty} b_n$  converges absolutely to  $AB$ .

**Proof** Let  $C_n$  be the  $n$ th partial sum of the Cauchy product; that is,

$$C_n = c_0 + c_1 + \cdots + c_n$$

(see (4.3.38)). Let  $\sum_{n=0}^{\infty} p_n$  be the series obtained by ordering the products  $\{a_i, b_j\}$  according to the scheme indicated in (4.3.35), and define  $P_n$  to be its  $n$ th partial sum; thus,

$$P_n = p_0 + p_1 + \cdots + p_n.$$

Inspection of (4.3.35) shows that  $c_n$  is the sum of the  $n+1$  terms connected by the diagonal arrows. Therefore,  $C_n = P_{m_n}$ , where

$$m_n = 1 + 2 + \cdots + (n+1) - 1 = \frac{n(n+3)}{2}.$$

From Theorem 4.3.27,  $\lim_{n \rightarrow \infty} P_{m_n} = AB$ , so  $\lim_{n \rightarrow \infty} C_n = AB$ . To see that  $\sum |c_n| < \infty$ , we observe that

$$\sum_{r=0}^n |c_r| \leq \sum_{s=0}^{m_n} |p_s|$$

and recall that  $\sum |p_s| < \infty$ , from Theorem 4.3.27. ■

**Example 4.3.25** Consider the Cauchy product of  $\sum_{n=0}^{\infty} r^n$  with itself. Here  $a_n = b_n = r^n$  and (4.3.39) yields

$$c_n = r^0 r^n + r^1 r^{n-1} + \cdots + r^{n-1} r^1 + r^n r^0 = (n+1)r^n,$$

so

$$\left( \sum_{n=0}^{\infty} r^n \right)^2 = \sum_{n=0}^{\infty} (n+1)r^n.$$

Since

$$\sum_{n=0}^{\infty} r^n = \frac{1}{1-r}, \quad |r| < 1,$$

and the convergence is absolute, Theorem 4.3.29 implies that

$$\sum_{n=0}^{\infty} (n+1)r^n = \frac{1}{(1-r)^2}, \quad |r| < 1.$$

**Example 4.3.26** If

$$\sum_{n=0}^{\infty} a_n = \sum_{n=0}^{\infty} \frac{\alpha^n}{n!} \quad \text{and} \quad \sum_{n=0}^{\infty} b_n = \sum_{n=0}^{\infty} \frac{\beta^n}{n!},$$

then (4.3.39) yields

$$c_n = \sum_{m=0}^n \frac{\alpha^{n-m} \beta^m}{(n-m)!m!} = \frac{1}{n!} \sum_{m=0}^n \binom{n}{m} \alpha^{n-m} \beta^m = \frac{(\alpha + \beta)^n}{n!};$$

thus,

$$\left( \sum_{n=0}^{\infty} \frac{\alpha^n}{n!} \right) \left( \sum_{n=0}^{\infty} \frac{\beta^n}{n!} \right) = \sum_{n=0}^{\infty} \frac{(\alpha + \beta)^n}{n!}. \quad (4.3.40)$$

You probably know from calculus that  $\sum_{n=0}^{\infty} x^n/n!$  converges absolutely for all  $x$  to  $e^x$ . Thus, (4.3.40) implies that

$$e^\alpha e^\beta = e^{\alpha+\beta},$$

a familiar result. ■

The Cauchy product of two series may converge under conditions weaker than those of Theorem 4.3.29. If one series converges absolutely and the other converges conditionally, the Cauchy product of the two series converges to the product of the two sums (Exercise 4.3.40). If two series and their Cauchy product all converge, then the sum of the Cauchy product equals the product of the sums of the two series (Exercise 4.5.32). However, the next example shows that the Cauchy product of two conditionally convergent series may diverge.

**Example 4.3.27** If

$$a_n = b_n = \frac{(-1)^{n+1}}{\sqrt{n+1}},$$

then  $\sum_{n=0}^{\infty} a_n$  and  $\sum_{n=0}^{\infty} b_n$  converge conditionally. From (4.3.39), the general term of their Cauchy product is

$$c_n = \sum_{r=0}^n \frac{(-1)^{r+1} (-1)^{n-r+1}}{\sqrt{r+1} \sqrt{n-r+1}} = (-1)^n \sum_{r=0}^n \frac{1}{\sqrt{r+1} \sqrt{n-r+1}},$$

so

$$|c_n| \geq \sum_{r=0}^n \frac{1}{\sqrt{n+1} \sqrt{n+1}} = \frac{n+1}{n+1} = 1.$$

Therefore, the Cauchy product diverges, by Corollary 4.3.6.

### 4.3 Exercises

---

1. Prove Theorem 4.3.2.
2. Prove Theorem 4.3.3.
3. (a) Prove: If  $a_n = b_n$  except for finitely many values of  $n$ , then  $\sum a_n$  and  $\sum b_n$  converge or diverge together.

- (b) Let  $b_{n_k} = a_k$  for some increasing sequence  $\{n_k\}_1^\infty$  of positive integers, and  $b_n = 0$  if  $n$  is any other positive integer. Show that

$$\sum_{n=1}^{\infty} b_n \quad \text{and} \quad \sum_{n=1}^{\infty} a_n$$

diverge or converge together, and that in the latter case they have the same sum. (Thus, the convergence properties of a series are not changed by inserting zeros between its terms.)

4. (a) Prove: If  $\sum a_n$  converges, then

$$\lim_{n \rightarrow \infty} (a_n + a_{n+1} + \cdots + a_{n+r}) = 0, \quad r \geq 0.$$

- (b) Does (a) imply that  $\sum a_n$  converges? Give a reason for your answer.

5. Prove Corollary 4.3.7.

6. (a) Verify Corollary 4.3.7 for the convergent series  $\sum 1/n^p$  ( $p > 1$ ). HINT: See the proof of Theorem 4.3.10.

- (b) Verify Corollary 4.3.7 for the convergent series  $\sum (-1)^n/n$ .

7. Prove: If  $0 \leq b_n \leq a_n \leq b_{n+1}$ , then  $\sum a_n$  and  $\sum b_n$  converge or diverge together.

8. Determine convergence or divergence.

(a)  $\sum \frac{\sqrt{n^2-1}}{\sqrt{n^5+1}}$

(b)  $\sum \frac{1}{n^2 [1 + \frac{1}{2} \sin(n\pi/4)]}$

(c)  $\sum \frac{1 - e^{-n} \log n}{n}$

(d)  $\sum \cos \frac{\pi}{n^2}$

(e)  $\sum \sin \frac{\pi}{n^2}$

(f)  $\sum \frac{1}{n} \tan \frac{\pi}{n}$

(g)  $\sum \frac{1}{n} \cot \frac{\pi}{n}$

(h)  $\sum \frac{\log n}{n^2}$

9. Suppose that  $f(x) \geq 0$  for  $x \geq k$ . Prove that  $\int_k^\infty f(x) dx < \infty$  if and only if

$$\sum_{n=k}^{\infty} \int_n^{n+1} f(x) dx < \infty.$$

HINT: Use Theorems 3.4.5 and 4.3.8.

10. Use the integral test to find all values of  $p$  for which the series converges.

(a)  $\sum \frac{n}{(n^2-1)^p}$

(b)  $\sum \frac{n^2}{(n^3+4)^p}$

(c)  $\sum \frac{\sinh n}{(\cosh n)^p}$

11. Let  $L_n$  be the  $n$ th iterated logarithm. Show that

$$\sum \frac{1}{L_0(n)L_1(n)\cdots L_k(n)[L_{k+1}(n)]^p}$$

converges if and only if  $p > 1$ . HINT: See Exercise 3.4.10.

12. Suppose that  $g$ ,  $g'$ , and  $(g')^2 - gg''$  are all positive on  $[R, \infty)$ . Show that

$$\sum \frac{g'(n)}{g(n)} < \infty$$

if and only if  $\lim_{x \rightarrow \infty} g(x) < \infty$ .

13. Let

$$S(p) = \sum_{n=1}^{\infty} \frac{1}{n^p}, \quad p > 1.$$

Show that

$$\frac{1}{(p-1)(N+1)^{p-1}} < S(p) - \sum_{n=1}^N \frac{1}{n^p} < \frac{1}{(p-1)N^{p-1}}.$$

HINT: See the proof of Theorem 4.3.10.

14. Suppose that  $f$  is positive, decreasing, and locally integrable on  $[1, \infty]$ , and let

$$a_n = \sum_{k=1}^n f(k) - \int_1^n f(x) dx.$$

- (a) Show that  $\{a_n\}$  is nonincreasing and nonnegative, and

$$0 < \lim_{n \rightarrow \infty} a_n < f(1).$$

- (b) Deduce from (a) that

$$\gamma = \lim_{n \rightarrow \infty} \left( 1 + \frac{1}{2} + \frac{1}{3} + \cdots + \frac{1}{n} - \log n \right)$$

exists, and  $0 < \gamma < 1$ . ( $\gamma$  is *Euler's constant*;  $\gamma \approx 0.577$ .)

15. Determine convergence or divergence.

(a)  $\sum \frac{2 + \sin n\theta}{n^2 + \sin n\theta}$

(b)  $\sum \frac{n+1}{n} r^n$  ( $r > 0$ )

(c)  $\sum e^{-n\rho} \cosh n\rho$  ( $\rho > 0$ )

(d)  $\sum \frac{n + \log n}{n^2(\log n)^2}$

(e)  $\sum \frac{n + \log n}{n^2 \log n}$

(f)  $\sum \frac{(1 + 1/n)^n}{2^n}$

16. Let  $L_n$  be the  $n$ th iterated logarithm. Prove that

$$\sum \frac{1}{[L_0(n)]^{q_0+1} [L_1(n)]^{q_1+1} \cdots [L_m(n)]^{q_m+1}}$$

converges if and only if there is at least one nonzero number in  $\{q_0, q_1, \dots, q_m\}$  and the first such is positive. HINT: See Exercises 4.3.11 and 2.4.42(b).

17. Determine convergence or divergence.

$$\begin{array}{ll} \text{(a)} \sum \frac{2 + \sin^2(n\pi/4)}{3^n} & \text{(b)} \sum \frac{n(n+1)}{4^n} \\ \text{(c)} \sum \frac{3 - \sin(n\pi/2)}{n(n+1)} & \text{(d)} \sum \frac{n + (-1)^n}{n(n+1)} \end{array}$$

18. Determine convergence or divergence, with  $r > 0$ .

$$\begin{array}{lll} \text{(a)} \sum \frac{n!}{r^n} & \text{(b)} \sum n^p r^n & \text{(c)} \sum \frac{r^n}{n!} \\ \text{(d)} \sum \frac{r^{2n+1}}{(2n+1)!} & \text{(e)} \sum \frac{r^{2n}}{(2n)!} \end{array}$$

19. Determine convergence or divergence.

$$\begin{array}{ll} \text{(a)} \sum \frac{(2n)!}{2^{2n}(n!)^2} & \text{(b)} \sum \frac{(3n)!}{3^{3n}n!(n+1)!(n+3)!} \\ \text{(c)} \sum \frac{2^n n!}{5 \cdots 7 \cdot (2n+3)} & \text{(d)} \sum \frac{\alpha(\alpha+1) \cdots (\alpha+n-1)}{\beta(\beta+1) \cdots (\beta+n-1)} \quad (\alpha, \beta > 0) \end{array}$$

20. Determine convergence or divergence.

$$\begin{array}{ll} \text{(a)} \sum \frac{n^n (2 + (-1)^n)}{2^n} & \text{(b)} \sum \left( \frac{1 + \sin 3n\theta}{3} \right)^n \\ \text{(c)} \sum (n+1) \left( \frac{1 + \sin(n\pi/6)}{3} \right)^n & \text{(d)} \sum \left( 1 - \frac{1}{n} \right)^{n^2} \end{array}$$

21. Give counterexamples showing that the following statements are false unless it is assumed that the terms of the series have the same sign for  $n$  sufficiently large.

- (a)  $\sum a_n$  converges if its partial sums are bounded.  
 (b) If  $b_n \neq 0$  for  $n \geq k$  and  $\lim_{n \rightarrow \infty} a_n/b_n = L$ , where  $0 < L < \infty$ , then  $\sum a_n$  and  $\sum b_n$  converge or diverge together.  
 (c) If  $a_n \neq 0$  and  $\overline{\lim}_{n \rightarrow \infty} a_{n+1}/a_n < 1$ , then  $\sum a_n$  converges.  
 (d) If  $a_n \neq 0$  and  $\overline{\lim}_{n \rightarrow \infty} n[(a_{n+1}/a_n) - 1] < -1$ , then  $\sum a_n$  converges.

22. Prove: If the terms of a convergent series  $\sum a_n$  have the same sign for  $n \geq k$ , then  $\sum a_n$  converges absolutely.

23. Suppose that  $a_n \geq 0$  for  $n \geq m$  and  $\sum a_n = \infty$ . Prove: If  $N$  is an arbitrary integer  $\geq m$  and  $J$  is an arbitrary positive number, then  $\sum_{n=N}^{N+k} a_n > J$  for some positive integer  $k$ .

24. Prove Theorem 4.3.19.



25. Show that the series converges absolutely.

$$(a) \sum (-1)^n \frac{1}{n(\log n)^2} \qquad (b) \sum \frac{\sin n\theta}{2^n}$$

$$(c) \sum (-1)^n \frac{1}{\sqrt{n}} \sin \frac{\pi}{n} \qquad (d) \sum \frac{\cos n\theta}{\sqrt{n^3 - 1}}$$

26. Show that the series converges.

$$(a) \sum \frac{n \sin n\theta}{n^2 + (-1)^n} \quad (-\infty < \theta < \infty) \quad (b) \sum \frac{\cos n\theta}{n} \quad (\theta \neq 2k\pi, k = \text{integer})$$

27. Determine whether the series is absolutely convergent, conditionally convergent, or divergent.

$$(a) \sum \frac{b_n}{\sqrt{n}} \quad (b_{4m} = b_{4m+1} = 1, b_{4m+2} = b_{4m+3} = -1)$$

$$(b) \sum \frac{1}{n} \sin \frac{n\pi}{6} \qquad (c) \sum \frac{1}{n^2} \cos \frac{n\pi}{7}$$

$$(d) \sum \frac{1 \cdot 3 \cdot 5 \cdots (2n+1)}{4 \cdot 6 \cdot 8 \cdots (2n+4)} \sin n\theta$$

28. Let  $g$  be a rational function (ratio of two polynomials). Show that  $\sum g(n)r^n$  converges absolutely if  $|r| < 1$  or diverges if  $|r| > 1$ . Discuss the possibilities for  $|r| = 1$ .

29. Prove: If  $\sum a_n^2 < \infty$  and  $\sum b_n^2 < \infty$ , then  $\sum a_n b_n$  converges absolutely.

30. (a) Prove: If  $\sum a_n$  converges and  $\sum a_n^2 = \infty$ , then  $\sum a_n$  converges conditionally.

(b) Give an example of a series with the properties described in (a).

31. Suppose that  $0 \leq a_{n+1} < a_n$  and

$$\lim_{n \rightarrow \infty} \frac{b_1 + b_2 + \cdots + b_n}{w_n} > 0,$$

where  $\{w_n\}$  is a sequence of positive numbers such that

$$\sum w_n(a_n - a_{n+1}) = \infty.$$

Show that  $\sum a_n b_n = \infty$ . HINT: Use summation by parts.

32. (a) Prove: If  $0 < 2\epsilon < \theta < \pi - 2\epsilon$ , then

$$\lim_{n \rightarrow \infty} \frac{|\sin \theta| + |\sin 2\theta| + \cdots + |\sin n\theta|}{n} \geq \frac{\sin \epsilon}{2}.$$

HINT: Show that  $|\sin n\theta| > \sin \epsilon$  at least "half the time"; more precisely, show that if  $|\sin m\theta| \leq \sin \epsilon$  for some integer  $m$  then  $|\sin(m+1)\theta| > \sin \epsilon$ .

(b) Show that

$$\sum \frac{\sin n\theta}{n^p}$$

converges conditionally if  $0 < p \leq 1$  and  $\theta \neq k\pi$  ( $k = \text{integer}$ ). HINT: Use Exercise 4.3.31 and see Example 4.3.22.

33. Show that

$$\sum_{n=1}^{\infty} \frac{(-1)^{n+1}}{n} = \frac{1}{2} \sum_{n=1}^{\infty} \frac{1}{n(2n-1)}.$$

34. Let  $b_{3m+1}, b_{3m+2} = -2$ , and  $b_{3m+3} = 1$  for  $m \geq 0$ . Show that

$$\sum_{n=1}^{\infty} \frac{b_n}{n} = \frac{2}{3} \sum_{m=0}^{\infty} \frac{1}{(m+1)(3m+1)(3m+2)}.$$

35. Let  $\sum b_n$  be obtained by rearranging finitely many terms of a convergent series  $\sum a_n$ . Show that the two series have the same sum.

36. Prove Theorem 4.3.26 for the case where (a)  $\mu$  is finite and  $\nu = \infty$ ; (b)  $\mu = -\infty$  and  $\nu = \infty$ ; (c)  $\mu = \nu = \infty$ .

37. Give necessary and sufficient conditions for a divergent series to have a convergent rearrangement.

38. A series diverges *unconditionally* to  $\infty$  if every rearrangement of the series diverges to  $\infty$ . State necessary and sufficient conditions for a series to have this property.

39. Suppose that  $f$  and  $g$  have derivatives of all orders at 0, and let  $h = fg$ . Show formally that

$$\left( \sum_{n=0}^{\infty} \frac{f^{(n)}(0)}{n!} x^n \right) \left( \sum_{n=0}^{\infty} \frac{g^{(n)}(0)}{n!} x^n \right) = \sum_{n=0}^{\infty} \frac{h^{(n)}(0)}{n!} x^n$$

in the sense of the Cauchy product. HINT: See Exercise 2.3.12.

40. Prove: If  $\sum |a_n| < \infty$  and  $\sum b_n$  converges (perhaps conditionally), with  $\sum_{n=0}^{\infty} a_n = A$  and  $\sum_{n=0}^{\infty} b_n = B$ , then the Cauchy product

$$\sum_{n=0}^{\infty} c_n = \left( \sum_{n=0}^{\infty} a_n \right) \left( \sum_{n=0}^{\infty} b_n \right)$$

converges to  $AB$ . HINT: Let  $\{A_n\}$ ,  $\{B_n\}$ , and  $\{C_n\}$  be the partial sums of the series. Show that

$$C_n - A_n B = \sum_{r=0}^n a_r (B_{n-r} - B)$$

and apply Theorem 4.3.5 to  $\sum |a_n|$ .

41. Suppose that  $a_r \geq 0$  for all  $r \geq 0$  and  $\sum_0^\infty a_r = A < \infty$ . Show that

$$\lim_{n \rightarrow \infty} \frac{1}{n} \sum_{r,s=0}^{n-1} a_{r+s} = 0 \quad \text{and} \quad \lim_{n \rightarrow \infty} \frac{1}{n} \sum_{r,s=0}^{n-1} a_{r-s} = 2A - a_0.$$

42. Prove: If  $\lim_{i \rightarrow \infty} a_j^{(i)} = a_j$  ( $j \geq 1$ ) and  $|a_j^{(i)}| \leq \sigma_j$  ( $i, j \geq 1$ ), where  $\sum_{j=1}^\infty \sigma_j < \infty$ , then  $\lim_{i \rightarrow \infty} \sum_{j=1}^\infty a_j^{(i)} = \sum_{j=1}^\infty a_j$ .

43. Prove: If  $a_n > 0$ ,  $n \geq 1$ , and  $\sum_{n=1}^\infty a_n = \infty$ , then  $\sum_{n=1}^\infty a_n / (1 + a_n) = \infty$ .

#### 4.4 SEQUENCES AND SERIES OF FUNCTIONS

Until now we have considered sequences and series of constants. Now we turn our attention to sequences and series of real-valued functions defined on subsets of the reals. Throughout this section, “subset” means “nonempty subset.”

If  $F_k, F_{k+1}, \dots, F_n, \dots$  are real-valued functions defined on a subset  $D$  of the reals, we say that  $\{F_n\}$  is an *infinite sequence* or (simply a *sequence*) of functions on  $D$ . If the sequence of values  $\{F_n(x)\}$  converges for each  $x$  in some subset  $S$  of  $D$ , then  $\{F_n\}$  defines a limit function on  $S$ . The formal definition is as follows.

**Definition 4.4.1** Suppose that  $\{F_n\}$  is a sequence of functions on  $D$  and the sequence of values  $\{F_n(x)\}$  converges for each  $x$  in some subset  $S$  of  $D$ . Then we say that  $\{F_n\}$  converges pointwise on  $S$  to the limit function  $F$ , defined by

$$F(x) = \lim_{n \rightarrow \infty} F_n(x), \quad x \in S.$$

**Example 4.4.1** The functions

$$F_n(x) = \left(1 - \frac{nx}{n+1}\right)^{n/2}, \quad n \geq 1,$$

define a sequence on  $D = (-\infty, 1]$ , and

$$\lim_{n \rightarrow \infty} F_n(x) = \begin{cases} \infty, & x < 0, \\ 1, & x = 0, \\ 0, & 0 < x \leq 1. \end{cases}$$

Therefore,  $\{F_n\}$  converges pointwise on  $S = [0, 1]$  to the limit function  $F$  defined by

$$F(x) = \begin{cases} 1, & x = 0, \\ 0, & 0 < x \leq 1. \end{cases}$$

**Example 4.4.2** Consider the functions

$$F_n(x) = x^n e^{-nx}, \quad x \geq 0, \quad n \geq 1,$$

(Figure 4.4.1).

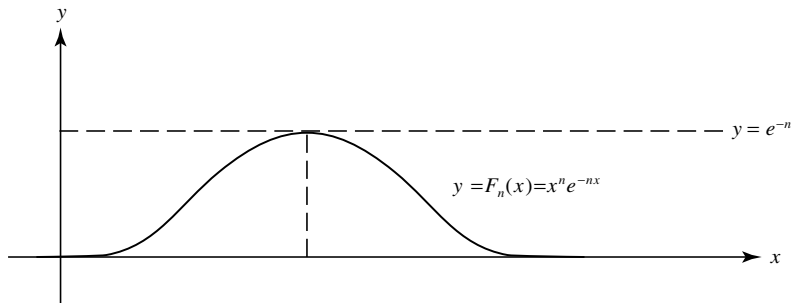


Figure 4.4.1

Equating the derivative

$$F'_n(x) = nx^{n-1}e^{-nx}(1-x)$$

to zero shows that the maximum value of  $F_n(x)$  on  $[0, \infty)$  is  $e^{-n}$ , attained at  $x = 1$ . Therefore,

$$|F_n(x)| \leq e^{-n}, \quad x \geq 0,$$

so  $\lim_{n \rightarrow \infty} F_n(x) = 0$  for all  $x \geq 0$ . The limit function in this case is identically zero on  $[0, \infty)$ .

**Example 4.4.3** For  $n \geq 1$ , let  $F_n$  be defined on  $(-\infty, \infty)$  by

$$F_n(x) = \begin{cases} 0, & x < -\frac{2}{n}, \\ -n(2 + nx), & -\frac{2}{n} \leq x < -\frac{1}{n}, \\ n^2x, & -\frac{1}{n} \leq x < \frac{1}{n}, \\ n(2 - nx), & \frac{1}{n} \leq x < \frac{2}{n}, \\ 0, & x \geq \frac{2}{n} \end{cases}$$

(Figure 4.4.2, page 236),

Since  $F_n(0) = 0$  for all  $n$ ,  $\lim_{n \rightarrow \infty} F_n(0) = 0$ . If  $x \neq 0$ , then  $F_n(x) = 0$  if  $n \geq 2/|x|$ . Therefore,

$$\lim_{n \rightarrow \infty} F_n(x) = 0, \quad -\infty < x < \infty,$$

so the limit function is identically zero on  $(-\infty, \infty)$ .

**Example 4.4.4** For each positive integer  $n$ , let  $S_n$  be the set of numbers of the form  $x = p/q$ , where  $p$  and  $q$  are integers with no common factors and  $1 \leq q \leq n$ . Define

$$F_n(x) = \begin{cases} 1, & x \in S_n, \\ 0, & x \notin S_n. \end{cases}$$

If  $x$  is irrational, then  $x \notin S_n$  for any  $n$ , so  $F_n(x) = 0$ ,  $n \geq 1$ . If  $x$  is rational, then  $x \in S_n$  and  $F_n(x) = 1$  for all sufficiently large  $n$ . Therefore,

$$\lim_{n \rightarrow \infty} F_n(x) = F(x) = \begin{cases} 1 & \text{if } x \text{ is rational,} \\ 0 & \text{if } x \text{ is irrational.} \end{cases}$$

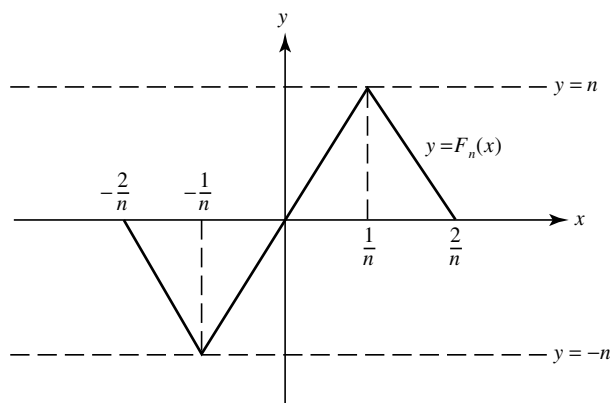


Figure 4.4.2

## Uniform Convergence

The pointwise limit of a sequence of functions may differ radically from the functions in the sequence. In Example 4.4.1, each  $F_n$  is continuous on  $(-\infty, 1]$ , but  $F$  is not. In Example 4.4.3, the graph of each  $F_n$  has two triangular spikes with heights that tend to  $\infty$  as  $n \rightarrow \infty$ , while the graph of  $F$  (the  $x$ -axis) has none. In Example 4.4.4, each  $F_n$  is integrable, while  $F$  is nonintegrable on every finite interval. (Exercise 4.4.3). There is nothing in Definition 4.4.1 to preclude these apparent anomalies; although the definition implies that for each  $x_0$  in  $S$ ,  $F_n(x_0)$  approximates  $F(x_0)$  if  $n$  is sufficiently large, it does not imply that any particular  $F_n$  approximates  $F$  well over *all* of  $S$ . To formulate a definition that does, it is convenient to introduce the notation

$$\|g\|_S = \sup_{x \in S} |g(x)|$$

and to state the following lemma. We leave the proof to you (Exercise 4.4.4).

**Lemma 4.4.2** *If  $g$  and  $h$  are defined on  $S$ , then*

$$\|g + h\|_S \leq \|g\|_S + \|h\|_S$$

and

$$\|gh\|_S \leq \|g\|_S \|h\|_S.$$

Moreover, if either  $g$  or  $h$  is bounded on  $S$ , then

$$\|g - h\|_S \geq \left| \|g\|_S - \|h\|_S \right|.$$

**Definition 4.4.3** A sequence  $\{F_n\}$  of functions defined on a set  $S$  converges uniformly to the limit function  $F$  on  $S$  if

$$\lim_{n \rightarrow \infty} \|F_n - F\|_S = 0.$$

Thus,  $\{F_n\}$  converges uniformly to  $F$  on  $S$  if for each  $\epsilon > 0$  there is an integer  $N$  such that

$$\|F_n - F\|_S < \epsilon \quad \text{if } n \geq N. \quad (4.4.1)$$

If  $S = [a, b]$  and  $F$  is the function with graph shown in Figure 4.4.3, then (4.4.1) implies that the graph of

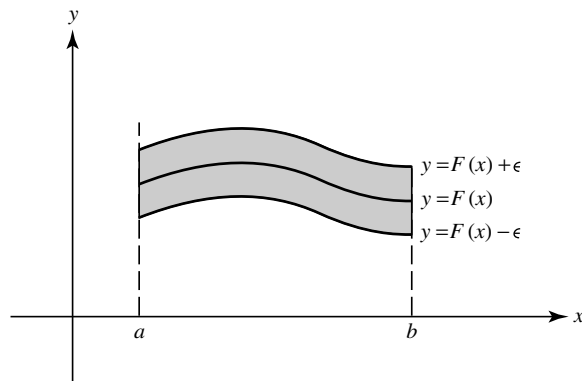
$$y = F_n(x), \quad a \leq x \leq b,$$

lies in the shaded band

$$F(x) - \epsilon < y < F(x) + \epsilon, \quad a \leq x \leq b,$$

if  $n \geq N$ .

From Definition 4.4.3, if  $\{F_n\}$  converges uniformly on  $S$ , then  $\{F_n\}$  converges uniformly on any subset of  $S$  (Exercise 4.4.6).



**Figure 4.4.3**

**Example 4.4.5** The sequence  $\{F_n\}$  defined by

$$F_n(x) = x^n e^{-nx}, \quad n \geq 1,$$

converges uniformly to  $F \equiv 0$  (that is, to the identically zero function) on  $S = [0, \infty)$ , since we saw in Example 4.4.2 that

$$\|F_n - F\|_S = \|F_n\|_S = e^{-n},$$

so

$$\|F_n - F\|_S < \epsilon$$

if  $n > -\log \epsilon$ . For these values of  $n$ , the graph of

$$y = F_n(x), \quad 0 \leq x < \infty,$$

lies in the strip

$$-\epsilon \leq y \leq \epsilon, \quad x \geq 0$$

(Figure 4.4.4). ■

The next theorem provides alternative definitions of pointwise and uniform convergence. It follows immediately from Definitions 4.4.1 and 4.4.3.

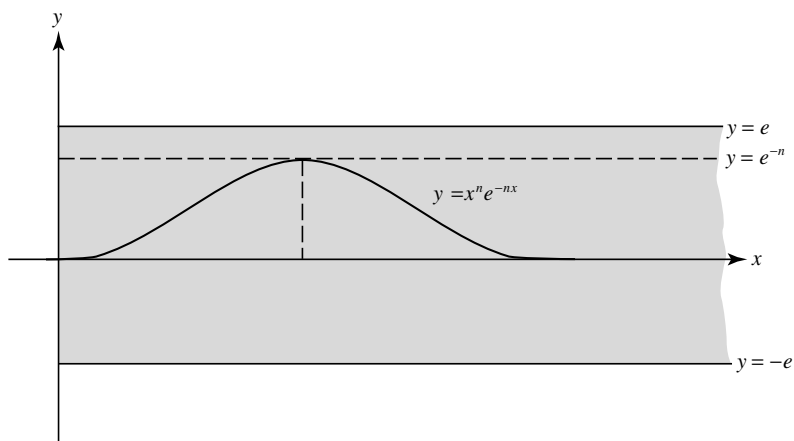
**Theorem 4.4.4** *Let  $\{F_n\}$  be defined on  $S$ . Then*

- (a)  $\{F_n\}$  converges pointwise to  $F$  on  $S$  if and only if there is, for each  $\epsilon > 0$  and  $x \in S$ , an integer  $N$  (which may depend on  $x$  as well as  $\epsilon$ ) such that

$$|F_n(x) - F(x)| < \epsilon \quad \text{if } n \geq N.$$

- (b)  $\{F_n\}$  converges uniformly to  $F$  on  $S$  if and only if there is for each  $\epsilon > 0$  an integer  $N$  (which depends only on  $\epsilon$  and not on any particular  $x$  in  $S$ ) such that

$$|F_n(x) - F(x)| < \epsilon \quad \text{for all } x \text{ in } S \text{ if } n \geq N.$$



**Figure 4.4.4**

The next theorem follows immediately from Theorem 4.4.4 and Example 4.4.6.

**Theorem 4.4.5** *If  $\{F_n\}$  converges uniformly to  $F$  on  $S$ , then  $\{F_n\}$  converges pointwise to  $F$  on  $S$ . The converse is false; that is, pointwise convergence does not imply uniform convergence.*

**Example 4.4.6** The sequence  $\{F_n\}$  of Example 4.4.3 converges pointwise to  $F \equiv 0$  on  $(-\infty, \infty)$ , but not uniformly, since

$$\|F_n - F\|_{(-\infty, \infty)} = F_n\left(\frac{1}{n}\right) = \left|F_n\left(\frac{-1}{n}\right)\right| = n,$$

so

$$\lim_{n \rightarrow \infty} \|F_n - F\|_{(-\infty, \infty)} = \infty.$$

However, the convergence is uniform on

$$S_\rho = (-\infty, \rho] \cup [\rho, \infty)$$

for any  $\rho > 0$ , since

$$\|F_n - F\|_{S_\rho} = 0 \quad \text{if } n > \frac{2}{\rho}.$$

**Example 4.4.7** If  $F_n(x) = x^n$ ,  $n \geq 1$ , then  $\{F_n\}$  converges pointwise on  $S = [0, 1]$  to

$$F(x) = \begin{cases} 1, & x = 1, \\ 0, & 0 \leq x < 1. \end{cases}$$

The convergence is not uniform on  $S$ . To see this, suppose that  $0 < \epsilon < 1$ . Then

$$|F_n(x) - F(x)| > 1 - \epsilon \quad \text{if } (1 - \epsilon)^{1/n} < x < 1.$$

Therefore,

$$1 - \epsilon \leq \|F_n - F\|_S \leq 1$$

for all  $n \geq 1$ . Since  $\epsilon$  can be arbitrarily small, it follows that

$$\|F_n - F\|_S = 1$$

for all  $n \geq 1$ .

However, the convergence is uniform on  $[0, \rho]$  if  $0 < \rho < 1$ , since then

$$\|F_n - F\|_{[0, \rho]} = \rho^n$$

and  $\lim_{n \rightarrow \infty} \rho^n = 0$ . Another way to say the same thing:  $\{F_n\}$  converges uniformly on every closed subset of  $[0, 1)$ . ■

The next theorem enables us to test a sequence for uniform convergence without guessing what the limit function might be. It is analogous to Cauchy's convergence criterion for sequences of constants (Theorem 4.1.13).



**Theorem 4.4.6 (Cauchy's Uniform Convergence Criterion)** *A sequence of functions  $\{F_n\}$  converges uniformly on a set  $S$  if and only if for each  $\epsilon > 0$  there is an integer  $N$  such that*

$$\|F_n - F_m\|_S < \epsilon \quad \text{if } n, m \geq N. \quad (4.4.2)$$

**Proof** For necessity, suppose that  $\{F_n\}$  converges uniformly to  $F$  on  $S$ . Then, if  $\epsilon > 0$ , there is an integer  $N$  such that

$$\|F_k - F\|_S < \frac{\epsilon}{2} \quad \text{if } k \geq N.$$

Therefore,

$$\begin{aligned} \|F_n - F_m\|_S &= \|(F_n - F) + (F - F_m)\|_S \\ &\leq \|F_n - F\|_S + \|F - F_m\|_S \quad (\text{Lemma 4.4.2}) \\ &< \frac{\epsilon}{2} + \frac{\epsilon}{2} = \epsilon \quad \text{if } m, n \geq N. \end{aligned}$$

For sufficiency, we first observe that (4.4.2) implies that

$$|F_n(x) - F_m(x)| < \epsilon \quad \text{if } n, m \geq N,$$

for any fixed  $x$  in  $S$ . Therefore, Cauchy's convergence criterion for sequences of constants (Theorem 4.1.13) implies that  $\{F_n(x)\}$  converges for each  $x$  in  $S$ ; that is,  $\{F_n\}$  converges pointwise to a limit function  $F$  on  $S$ . To see that the convergence is uniform, we write

$$\begin{aligned} |F_m(x) - F(x)| &= |[F_m(x) - F_n(x)] + [F_n(x) - F(x)]| \\ &\leq |F_m(x) - F_n(x)| + |F_n(x) - F(x)| \\ &\leq \|F_m - F_n\|_S + |F_n(x) - F(x)|. \end{aligned}$$

This and (4.4.2) imply that

$$|F_m(x) - F(x)| < \epsilon + |F_n(x) - F(x)| \quad \text{if } n, m \geq N. \quad (4.4.3)$$

Since  $\lim_{n \rightarrow \infty} F_n(x) = F(x)$ ,

$$|F_n(x) - F(x)| < \epsilon$$

for some  $n \geq N$ , so (4.4.3) implies that

$$|F_m(x) - F(x)| < 2\epsilon \quad \text{if } m \geq N.$$

But this inequality holds for all  $x$  in  $S$ , so

$$\|F_m - F\|_S \leq 2\epsilon \quad \text{if } m \geq N.$$

Since  $\epsilon$  is an arbitrary positive number, this implies that  $\{F_n\}$  converges uniformly to  $F$  on  $S$ . ■

The next example is similar to Example 4.1.14.

**Example 4.4.8** Suppose that  $g$  is differentiable on  $S = (-\infty, \infty)$  and

$$|g'(x)| \leq r < 1, \quad -\infty < x < \infty. \quad (4.4.4)$$

Let  $F_0$  be bounded on  $S$  and define

$$F_n(x) = g(F_{n-1}(x)), \quad n \geq 1. \quad (4.4.5)$$

We will show that  $\{F_n\}$  converges uniformly on  $S$ . We first note that if  $u$  and  $v$  are any two real numbers, then (4.4.4) and the mean value theorem imply that

$$|g(u) - g(v)| \leq r|u - v|. \quad (4.4.6)$$

Recalling (4.4.5) and applying this inequality with  $u = F_{n-1}(x)$  and  $v = 0$  shows that

$$\begin{aligned} |F_n(x)| &= |g(0) + (g(F_{n-1}(x)) - g(0))| \leq |g(0)| + |g(F_{n-1}(x)) - g(0)| \\ &\leq |g(0)| + r|F_{n-1}(x)|; \end{aligned}$$

therefore, since  $F_0$  is bounded on  $S$ , it follows by induction that  $F_n$  is bounded on  $S$  for  $n \geq 1$ . Moreover, if  $n \geq 1$ , then (4.4.5) and (4.4.6) with  $u = F_n(x)$  and  $v = F_{n-1}(x)$  imply that

$$|F_{n+1}(x) - F_n(x)| = |g(F_n(x)) - g(F_{n-1}(x))| \leq r|F_n(x) - F_{n-1}(x)|, \quad -\infty < x < \infty,$$

so

$$\|F_{n+1} - F_n\|_S \leq r\|F_n - F_{n-1}\|_S.$$

By induction, this implies that

$$\|F_{n+1} - F_n\|_S \leq r^n\|F_1 - F_0\|_S. \quad (4.4.7)$$

If  $n > m$ , then

$$\begin{aligned} \|F_n - F_m\|_S &= \|(F_n - F_{n-1}) + (F_{n-1} - F_{n-2}) + \cdots + (F_{m+1} - F_m)\|_S \\ &\leq \|F_n - F_{n-1}\|_S + \|F_{n-1} - F_{n-2}\|_S + \cdots + \|F_{m+1} - F_m\|_S, \end{aligned}$$

from Lemma 4.4.2. Now (4.4.7) implies that

$$\begin{aligned} \|F_n - F_m\|_S &\leq \|F_1 - F_0\|_S(1 + r + r^2 + \cdots + r^{n-m-1})r^m \\ &< \|F_1 - F_0\|_S \frac{r^m}{1-r}. \end{aligned}$$

Therefore, if

$$\|F_1 - F_0\|_S \frac{r^N}{1-r} < \epsilon,$$

then  $\|F_n - F_m\|_S < \epsilon$  if  $n, m \geq N$ . Therefore,  $\{F_n\}$  converges uniformly on  $S$ , by Theorem 4.4.6.

### Properties Preserved by Uniform Convergence

We now study properties of the functions of a uniformly convergent sequence that are inherited by the limit function. We first consider continuity.

**Theorem 4.4.7** *If  $\{F_n\}$  converges uniformly to  $F$  on  $S$  and each  $F_n$  is continuous at a point  $x_0$  in  $S$ , then so is  $F$ . Similar statements hold for continuity from the right and left.*

**Proof** Suppose that each  $F_n$  is continuous at  $x_0$ . If  $x \in S$  and  $n \geq 1$ , then

$$\begin{aligned} |F(x) - F(x_0)| &\leq |F(x) - F_n(x)| + |F_n(x) - F_n(x_0)| + |F_n(x_0) - F(x_0)| \\ &\leq |F_n(x) - F_n(x_0)| + 2\|F_n - F\|_S. \end{aligned} \quad (4.4.8)$$

Suppose that  $\epsilon > 0$ . Since  $\{F_n\}$  converges uniformly to  $F$  on  $S$ , we can choose  $n$  so that  $\|F_n - F\|_S < \epsilon$ . For this fixed  $n$ , (4.4.8) implies that

$$|F(x) - F(x_0)| < |F_n(x) - F_n(x_0)| + 2\epsilon, \quad x \in S. \quad (4.4.9)$$

Since  $F_n$  is continuous at  $x_0$ , there is a  $\delta > 0$  such that

$$|F_n(x) - F_n(x_0)| < \epsilon \quad \text{if} \quad |x - x_0| < \delta,$$

so, from (4.4.9),

$$|F(x) - F(x_0)| < 3\epsilon, \quad \text{if} \quad |x - x_0| < \delta.$$

Therefore,  $F$  is continuous at  $x_0$ . Similar arguments apply to the assertions on continuity from the right and left. ■

**Corollary 4.4.8** *If  $\{F_n\}$  converges uniformly to  $F$  on  $S$  and each  $F_n$  is continuous on  $S$ , then so is  $F$ ; that is, a uniform limit of continuous functions is continuous.*

Now we consider the question of integrability of the uniform limit of integrable functions.

**Theorem 4.4.9** *Suppose that  $\{F_n\}$  converges uniformly to  $F$  on  $S = [a, b]$ . Assume that  $F$  and all  $F_n$  are integrable on  $[a, b]$ . Then*

$$\int_a^b F(x) dx = \lim_{n \rightarrow \infty} \int_a^b F_n(x) dx. \quad (4.4.10)$$

**Proof** Since

$$\begin{aligned} \left| \int_a^b F_n(x) dx - \int_a^b F(x) dx \right| &\leq \int_a^b |F_n(x) - F(x)| dx \\ &\leq (b - a)\|F_n - F\|_S \end{aligned}$$

and  $\lim_{n \rightarrow \infty} \|F_n - F\|_S = 0$ , the conclusion follows. ■

In particular, this theorem implies that (4.4.10) holds if each  $F_n$  is continuous on  $[a, b]$ , because then  $F$  is continuous (Corollary 4.4.8) and therefore integrable on  $[a, b]$ .

The hypotheses of Theorem 4.4.9 are stronger than necessary. We state the next theorem so that you will be better informed on this subject. We omit the proof, which is inaccessible if you skipped Section 3.5, and quite involved in any case.

**Theorem 4.4.10** *Suppose that  $\{F_n\}$  converges pointwise to  $F$  and each  $F_n$  is integrable on  $[a, b]$ .*

- (a) *If the convergence is uniform, then  $F$  is integrable on  $[a, b]$  and (4.4.10) holds.*  
 (b) *If the sequence  $\{\|F_n\|_{[a,b]}\}$  is bounded and  $F$  is integrable on  $[a, b]$ , then (4.4.10) holds.*

Part (a) of this theorem shows that it is not necessary to assume in Theorem 4.4.9 that  $F$  is integrable on  $[a, b]$ , since this follows from the uniform convergence. Part (b) is known as the *bounded convergence theorem*. Neither of the assumptions of (b) can be omitted. Thus, in Example 4.4.3, where  $\{\|F_n\|_{[0,1]}\}$  is unbounded while  $F$  is integrable on  $[0, 1]$ ,

$$\int_0^1 F_n(x) dx = 1, \quad n \geq 1, \quad \text{but} \quad \int_0^1 F(x) dx = 0.$$

In Example 4.4.4, where  $\|F_n\|_{[a,b]} = 1$  for every finite interval  $[a, b]$ ,  $F_n$  is integrable for all  $n \geq 1$ , and  $F$  is nonintegrable on every interval (Exercise 4.4.3).

After Theorems 4.4.7 and 4.4.9, it may seem reasonable to expect that if a sequence  $\{F_n\}$  of differentiable functions converges uniformly to  $F$  on  $S$ , then  $F' = \lim_{n \rightarrow \infty} F'_n$  on  $S$ . The next example shows that this is not true in general.

**Example 4.4.9** The sequence  $\{F_n\}$  defined by

$$F_n(x) = x^n \sin \frac{1}{x^{n-1}}$$

converges uniformly to  $F \equiv 0$  on  $[r_1, r_2]$  if  $0 < r_1 < r_2 < 1$  (or, equivalently, on every compact subset of  $(0, 1)$ ). However,

$$F'_n(x) = nx^{n-1} \sin \frac{1}{x^{n-1}} - (n-1) \cos \frac{1}{x^{n-1}},$$

so  $\{F'_n(x)\}$  does not converge for any  $x$  in  $(0, 1)$ .

**Theorem 4.4.11** *Suppose that  $F'_n$  is continuous on  $[a, b]$  for all  $n \geq 1$  and  $\{F'_n\}$  converges uniformly on  $[a, b]$ . Suppose also that  $\{F_n(x_0)\}$  converges for some  $x_0$  in  $[a, b]$ . Then  $\{F_n\}$  converges uniformly on  $[a, b]$  to a differentiable limit function  $F$ , and*

$$F'(x) = \lim_{n \rightarrow \infty} F'_n(x), \quad a < x < b, \quad (4.4.11)$$

while

$$F'_+(a) = \lim_{n \rightarrow \infty} F'_n(a+) \quad \text{and} \quad F'_-(b) = \lim_{n \rightarrow \infty} F'_n(b-). \quad (4.4.12)$$

**Proof** Since  $F'_n$  is continuous on  $[a, b]$ , we can write

$$F_n(x) = F_n(x_0) + \int_{x_0}^x F'_n(t) dt, \quad a \leq x \leq b \quad (4.4.13)$$

(Theorem 3.3.12). Now let

$$L = \lim_{n \rightarrow \infty} F_n(x_0)$$

and

$$G(x) = \lim_{n \rightarrow \infty} F'_n(x). \quad (4.4.14)$$

Since  $F'_n$  is continuous and  $\{F'_n\}$  converges uniformly to  $G$  on  $[a, b]$ ,  $G$  is continuous on  $[a, b]$  (Corollary 4.4.8); therefore, (4.4.13) and Theorem 4.4.9 (with  $F$  and  $F_n$  replaced by  $G$  and  $F'_n$ ) imply that  $\{F_n\}$  converges pointwise on  $[a, b]$  to the limit function

$$F(x) = L + \int_{x_0}^x G(t) dt. \quad (4.4.15)$$

The convergence is actually uniform on  $[a, b]$ , since subtracting (4.4.13) from (4.4.15) yields

$$\begin{aligned} |F(x) - F_n(x)| &\leq |L - F_n(x_0)| + \left| \int_{x_0}^x |G(t) - F'_n(t)| dt \right| \\ &\leq |L - F_n(x_0)| + |x - x_0| \|G - F'_n\|_{[a,b]}, \end{aligned}$$

so

$$\|F - F_n\|_{[a,b]} \leq |L - F_n(x_0)| + (b - a) \|G - F'_n\|_{[a,b]},$$

where the right side approaches zero as  $n \rightarrow \infty$ .

Since  $G$  is continuous on  $[a, b]$ , (4.4.14), (4.4.15), Definition 2.3.6, and Theorem 3.3.11 imply (4.4.11) and (4.4.12). ■

## Infinite Series of Functions

In Section 4.3 we defined the sum of an infinite series of constants as the limit of the sequence of partial sums. The same definition can be applied to series of functions, as follows.

**Definition 4.4.12** If  $\{f_j\}_k^\infty$  is a sequence of real-valued functions defined on a set  $D$  of reals, then  $\sum_{j=k}^\infty f_j$  is an *infinite series* (or simply a *series*) of functions on  $D$ . The *partial sums* of,  $\sum_{j=k}^\infty f_j$  are defined by

$$F_n = \sum_{j=k}^n f_j, \quad n \geq k.$$

If  $\{F_n\}_k^\infty$  converges pointwise to a function  $F$  on a subset  $S$  of  $D$ , we say that  $\sum_{j=k}^\infty f_j$  *converges pointwise to the sum  $F$  on  $S$* , and write

$$F = \sum_{j=k}^\infty f_j, \quad x \in S.$$

If  $\{F_n\}$  converges uniformly to  $F$  on  $S$ , we say that  $\sum_{j=k}^{\infty} f_j$  converges uniformly to  $F$  on  $S$ .

**Example 4.4.10** The functions

$$f_j(x) = x^j, \quad j \geq 0,$$

define the infinite series

$$\sum_{j=0}^{\infty} x^j$$

on  $D = (-\infty, \infty)$ . The  $n$ th partial sum of the series is

$$F_n(x) = 1 + x + x^2 + \cdots + x^n,$$

or, in closed form,

$$F_n(x) = \begin{cases} \frac{1-x^{n+1}}{1-x}, & x \neq 1, \\ n+1, & x = 1 \end{cases}$$

(Example 4.1.11). We have seen earlier that  $\{F_n\}$  converges pointwise to

$$F(x) = \frac{1}{1-x}$$

if  $|x| < 1$  and diverges if  $|x| \geq 1$ ; hence, we write

$$\sum_{j=0}^{\infty} x^j = \frac{1}{1-x}, \quad -1 < x < 1.$$

Since the difference

$$F(x) - F_n(x) = \frac{x^{n+1}}{1-x}$$

can be made arbitrarily large by taking  $x$  close to 1,

$$\|F - F_n\|_{(-1,1)} = \infty,$$

so the convergence is not uniform on  $(-1, 1)$ . Neither is it uniform on any interval  $(-1, r]$  with  $-1 < r < 1$ , since

$$\|F - F_n\|_{(-1,r)} \geq \frac{1}{2}$$

for every  $n$  on every such interval. (Why?) The series does converge uniformly on any interval  $[-r, r]$  with  $0 < r < 1$ , since

$$\|F - F_n\|_{[-r,r]} = \frac{r^{n+1}}{1-r}$$

and  $\lim_{n \rightarrow \infty} r^n = 0$ . Put another way, the series converges uniformly on closed subsets of  $(-1, 1)$ . ■

As for series of constants, the convergence, pointwise or uniform, of a series of functions is not changed by altering or omitting finitely many terms. This justifies adopting the convention that we used for series of constants: when we are interested only in whether a series of functions converges, and not in its sum, we will omit the limits on the summation sign and write simply  $\sum f_n$ .

### Tests for Uniform Convergence of Series

Theorem 4.4.6 is easily converted to a theorem on uniform convergence of series, as follows.

**Theorem 4.4.13 (Cauchy's Uniform Convergence Criterion)** *A series  $\sum f_n$  converges uniformly on a set  $S$  if and only if for each  $\epsilon > 0$  there is an integer  $N$  such that*

$$\|f_n + f_{n+1} + \cdots + f_m\|_S < \epsilon \quad \text{if } m \geq n \geq N. \quad (4.4.16)$$

**Proof** Apply Theorem 4.4.6 to the partial sums of  $\sum f_n$ , observing that

$$f_n + f_{n+1} + \cdots + f_m = F_m - F_{n-1}.$$

■

Setting  $m = n$  in (4.4.16) yields the following necessary, but not sufficient, condition for uniform convergence of series. It is analogous to Corollary 4.3.6.

**Corollary 4.4.14** *If  $\sum f_n$  converges uniformly on  $S$ , then  $\lim_{n \rightarrow \infty} \|f_n\|_S = 0$ .*

Theorem 4.4.13 leads immediately to the following important test for uniform convergence of series.

**Theorem 4.4.15 (Weierstrass's Test)** *The series  $\sum f_n$  converges uniformly on  $S$  if*

$$\|f_n\|_S \leq M_n, \quad n \geq k, \quad (4.4.17)$$

where  $\sum M_n < \infty$ .

**Proof** From Cauchy's convergence criterion for series of constants, there is for each  $\epsilon > 0$  an integer  $N$  such that

$$M_n + M_{n+1} + \cdots + M_m < \epsilon \quad \text{if } m \geq n \geq N,$$

which, because of (4.4.17), implies that

$$\|f_n\|_S + \|f_{n+1}\|_S + \cdots + \|f_m\|_S < \epsilon \quad \text{if } m, n \geq N.$$

Lemma 4.4.2 and Theorem 4.4.13 imply that  $\sum f_n$  converges uniformly on  $S$ . ■

**Example 4.4.11** Taking  $M_n = 1/n^2$  and recalling that

$$\sum \frac{1}{n^2} < \infty,$$

we see that

$$\sum \frac{1}{x^2 + n^2} \quad \text{and} \quad \sum \frac{\sin nx}{n^2}$$

converge uniformly on  $(-\infty, \infty)$ .

**Example 4.4.12** The series

$$\sum f_n(x) = \sum \left( \frac{x}{1+x} \right)^n$$

converges uniformly on any set  $S$  such that

$$\left| \frac{x}{1+x} \right| \leq r < 1, \quad x \in S, \quad (4.4.18)$$

because if  $S$  is such a set, then

$$\|f_n\|_S \leq r^n$$

and Weierstrass's test applies, with

$$\sum M_n = \sum r^n < \infty.$$

Since (4.4.18) is equivalent to

$$\frac{-r}{1+r} \leq x \leq \frac{r}{1-r}, \quad x \in S,$$

this means that the series converges uniformly on any compact subset of  $(-1/2, \infty)$ . (Why?) From Corollary 4.4.14, the series does not converge uniformly on  $S = (-1/2, b)$  with  $b < \infty$  or on  $S = [a, \infty)$  with  $a > -1/2$ , because in these cases  $\|f_n\|_S = 1$  for all  $n$ . ■

Weierstrass's test is very important, but applicable only to series that actually exhibit a stronger kind of convergence than we have considered so far. We say that  $\sum f_n$  converges *absolutely on  $S$*  if  $\sum |f_n|$  converges pointwise on  $S$ , and *absolutely uniformly on  $S$*  if  $\sum |f_n|$  converges uniformly on  $S$ . We leave it to you (Exercise 4.4.21) to verify that our proof of Weierstrass's test actually shows that  $\sum f_n$  converges absolutely uniformly on  $S$ . We also leave it to you to show that if a series converges absolutely uniformly on  $S$ , then it converges uniformly on  $S$  (Exercise 4.4.20).

The next theorem applies to series that converge uniformly, but perhaps not absolutely uniformly, on a set  $S$ .



**Theorem 4.4.16 (Dirichlet's Test for Uniform Convergence)** *The series*

$$\sum_{n=k}^{\infty} f_n g_n$$

*converges uniformly on  $S$  if  $\{f_n\}$  converges uniformly to zero on  $S$ ,  $\sum(f_{n+1} - f_n)$  converges absolutely uniformly on  $S$ , and*

$$\|g_k + g_{k+1} + \cdots + g_n\|_S \leq M, \quad n \geq k, \quad (4.4.19)$$

*for some constant  $M$ .*

**Proof** The proof is similar to the proof of Theorem 4.3.20. Let

$$G_n = g_k + g_{k+1} + \cdots + g_n,$$

and consider the partial sums of  $\sum_{n=k}^{\infty} f_n g_n$ :

$$H_n = f_k g_k + f_{k+1} g_{k+1} + \cdots + f_n g_n. \quad (4.4.20)$$

By substituting

$$g_k = G_k \quad \text{and} \quad g_n = G_n - G_{n-1}, \quad n \geq k+1,$$

into (4.4.20), we obtain

$$H_n = f_k G_k + f_{k+1}(G_{k+1} - G_k) + \cdots + f_n(G_n - G_{n-1}),$$

which we rewrite as

$$H_n = (f_k - f_{k+1})G_k + (f_{k+1} - f_{k+2})G_{k+1} + \cdots + (f_{n-1} - f_n)G_{n-1} + f_n G_n,$$

or

$$H_n = J_{n-1} + f_n G_n, \quad (4.4.21)$$

where

$$J_{n-1} = (f_k - f_{k+1})G_k + (f_{k+1} - f_{k+2})G_{k+1} + \cdots + (f_{n-1} - f_n)G_{n-1}. \quad (4.4.22)$$

That is,  $\{J_n\}$  is the sequence of partial sums of the series

$$\sum_{j=k}^{\infty} (f_j - f_{j+1})G_j. \quad (4.4.23)$$

From (4.4.19) and the definition of  $G_j$ ,

$$\left| \sum_{j=n}^m [f_j(x) - f_{j+1}(x)]G_j(x) \right| \leq M \sum_{j=n}^m |f_j(x) - f_{j+1}(x)|, \quad x \in S,$$

so

$$\left\| \sum_{j=n}^m (f_j - f_{j+1})G_j \right\|_S \leq M \left\| \sum_{j=n}^m |f_j - f_{j+1}| \right\|_S.$$

Now suppose that  $\epsilon > 0$ . Since  $\sum (f_j - f_{j+1})$  converges absolutely uniformly on  $S$ , Theorem 4.4.13 implies that there is an integer  $N$  such that the right side of the last inequality is less than  $\epsilon$  if  $m \geq n \geq N$ . The same is then true of the left side, so Theorem 4.4.13 implies that (4.4.23) converges uniformly on  $S$ .

We have now shown that  $\{J_n\}$  as defined in (4.4.22) converges uniformly to a limit function  $J$  on  $S$ . Returning to (4.4.21), we see that

$$H_n - J = J_{n-1} - J + f_n G_n.$$

Hence, from Lemma 4.4.2 and (4.4.19),

$$\begin{aligned} \|H_n - J\|_S &\leq \|J_{n-1} - J\|_S + \|f_n\|_S \|G_n\|_S \\ &\leq \|J_{n-1} - J\|_S + M \|f_n\|_S. \end{aligned}$$

Since  $\{J_{n-1} - J\}$  and  $\{f_n\}$  converge uniformly to zero on  $S$ , it now follows that  $\lim_{n \rightarrow \infty} \|H_n - J\|_S = 0$ . Therefore,  $\{H_n\}$  converges uniformly on  $S$ . ■

**Corollary 4.4.17** *The series  $\sum_{n=k}^{\infty} f_n g_n$  converges uniformly on  $S$  if*

$$f_{n+1}(x) \leq f_n(x), \quad x \in S, \quad n \geq k,$$

*$\{f_n\}$  converges uniformly to zero on  $S$ , and*

$$\|g_k + g_{k+1} + \cdots + g_n\|_S \leq M, \quad n \geq k,$$

*for some constant  $M$ .*

The proof is similar to that of Corollary 4.3.21. We leave it to you (Exercise 4.4.22).

**Example 4.4.13** Consider the series

$$\sum_{n=1}^{\infty} \frac{\sin nx}{n}$$

with  $f_n = 1/n$  (constant),  $g_n(x) = \sin nx$ , and

$$G_n(x) = \sin x + \sin 2x + \cdots + \sin nx.$$

We saw in Example 4.3.21 that

$$|G_n(x)| \leq \frac{1}{|\sin(x/2)|}, \quad n \geq 1, \quad n \neq 2k\pi \quad (k = \text{integer}).$$

Therefore,  $\{\|G_n\|_S\}$  is bounded, and the series converges uniformly on any set  $S$  on which  $\sin x/2$  is bounded away from zero. For example, if  $0 < \delta < \pi$ , then

$$\left| \sin \frac{x}{2} \right| \geq \sin \frac{\delta}{2}$$

if  $x$  is at least  $\delta$  away from any multiple of  $2\pi$ ; hence, the series converges uniformly on

$$S = \bigcup_{k=-\infty}^{\infty} [2k\pi + \delta, 2(k+1)\pi - \delta].$$

Since

$$\sum \left| \frac{\sin nx}{n} \right| = \infty, \quad x \neq k\pi$$

(Exercise 4.3.32(b)), this result cannot be obtained from Weierstrass's test.

**Example 4.4.14** The series

$$\sum_{n=1}^{\infty} \frac{(-1)^n}{n+x^2}$$

satisfies the hypotheses of Corollary 4.4.17 on  $(-\infty, \infty)$ , with

$$f_n(x) = \frac{1}{n+x^2}, \quad g_n = (-1)^n, \quad G_{2m} = 0, \quad \text{and} \quad G_{2m+1} = -1.$$

Therefore, the series converges uniformly on  $(-\infty, \infty)$ . This result cannot be obtained by Weierstrass's test, since

$$\sum \frac{1}{n+x^2} = \infty$$

for all  $x$ .

### Continuity, Differentiability, and Integrability of Series

We can obtain results on the continuity, differentiability, and integrability of infinite series by applying Theorems 4.4.7, 4.4.9, and 4.4.11 to their partial sums. We will state the theorems and give some examples, leaving the proofs to you.

Theorem 4.4.7 implies the following theorem (Exercise 4.4.23).

**Theorem 4.4.18** *If  $\sum_{n=k}^{\infty} f_n$  converges uniformly to  $F$  on  $S$  and each  $f_n$  is continuous at a point  $x_0$  in  $S$ , then so is  $F$ . Similar statements hold for continuity from the right and left.*

**Example 4.4.15** In Example 4.4.12 we saw that the series

$$F(x) = \sum_{n=0}^{\infty} \left( \frac{x}{1+x} \right)^n$$

converges uniformly on every compact subset of  $(-1/2, \infty)$ . Since the terms of the series are continuous on every such subset, Theorem 4.4.4 implies that  $F$  is also. In fact, we can state a stronger result:  $F$  is continuous on  $(-1/2, \infty)$ , since every point in  $(-1/2, \infty)$  lies in a compact subinterval of  $(-1/2, \infty)$ .

The same argument and the results of Example 4.4.13 show that the function

$$G(x) = \sum_{n=1}^{\infty} \frac{\sin nx}{n}$$

is continuous except perhaps at  $x_k = 2k\pi$  ( $k = \text{integer}$ ).

From Example 4.4.14, the function

$$H(x) = \sum_{n=1}^{\infty} (-1)^n \frac{1}{n+x^2}$$

is continuous for all  $x$ . ■

The next theorem gives conditions that permit the interchange of summation and integration of infinite series. It follows from Theorem 4.4.9 (Exercise 4.4.25). We leave it to you to formulate an analog of Theorem 4.4.10 for series (Exercise 4.4.26).

**Theorem 4.4.19** Suppose that  $\sum_{n=k}^{\infty} f_n$  converges uniformly to  $F$  on  $S = [a, b]$ . Assume that  $F$  and  $f_n$ ,  $n \geq k$ , are integrable on  $[a, b]$ . Then

$$\int_a^b F(x) dx = \sum_{n=k}^{\infty} \int_a^b f_n(x) dx.$$

We say in this case that  $\sum_{n=k}^{\infty} f_n$  can be integrated *term by term* over  $[a, b]$ .

**Example 4.4.16** From Example 4.4.10,

$$\frac{1}{1-x} = \sum_{n=0}^{\infty} x^n, \quad -1 < x < 1.$$

The series converges uniformly, and the limit function is integrable on any closed subinterval  $[a, b]$  of  $(-1, 1)$ ; hence,

$$\int_a^b \frac{dx}{1-x} = \sum_{n=0}^{\infty} \int_a^b x^n dx,$$

so

$$\log(1-a) - \log(1-b) = \sum_{n=0}^{\infty} \frac{b^{n+1} - a^{n+1}}{n+1}.$$

Letting  $a = 0$  and  $b = x$  yields

$$\log(1-x) = - \sum_{n=0}^{\infty} \frac{x^{n+1}}{n+1}, \quad -1 < x < 1. \quad \blacksquare$$

The next theorem gives conditions that permit the interchange of summation and differentiation of infinite series. It follows from Theorem 4.4.11 (Exercise 4.4.28).

**Theorem 4.4.20** Suppose that  $f_n$  is continuously differentiable on  $[a, b]$  for each  $n \geq k$ ,  $\sum_{n=k}^{\infty} f_n(x_0)$  converges for some  $x_0$  in  $[a, b]$ , and  $\sum_{n=k}^{\infty} f'_n$  converges uniformly on  $[a, b]$ . Then  $\sum_{n=k}^{\infty} f_n$  converges uniformly on  $[a, b]$  to a differentiable function  $F$ , and

$$F'(x) = \sum_{n=k}^{\infty} f'_n(x), \quad a < x < b,$$

while

$$F'(a+) = \sum_{n=k}^{\infty} f'_n(a+) \quad \text{and} \quad F'(b-) = \sum_{n=k}^{\infty} f'_n(b-).$$

We say in this case that  $\sum_{n=k}^{\infty} f_n$  can be differentiated *term by term* on  $[a, b]$ . To apply Theorem 4.4.20, we first verify that  $\sum_{n=k}^{\infty} f_n(x_0)$  converges for some  $x_0$  in  $[a, b]$  and then differentiate  $\sum_{n=k}^{\infty} f_n$  term by term. If the resulting series converges uniformly, then term by term differentiation was legitimate.

**Example 4.4.17** The series

$$\sum_{n=1}^{\infty} (-1)^n \frac{1}{n} \cos \frac{x}{n} \tag{4.4.24}$$

converges at  $x_0 = 0$ . Differentiating term by term yields the series

$$\sum_{n=1}^{\infty} (-1)^{n+1} \frac{1}{n^2} \sin \frac{x}{n} \tag{4.4.25}$$

of continuous functions. This series converges uniformly on  $(-\infty, \infty)$ , by Weierstrass's test. By Theorem 4.4.20, the series (4.4.24) converges uniformly on every finite interval to the differentiable function

$$F(x) = \sum_{n=1}^{\infty} (-1)^n \frac{1}{n} \cos \frac{x}{n}, \quad -\infty < x < \infty,$$

and

$$F'(x) = \sum_{n=1}^{\infty} (-1)^{n+1} \frac{1}{n^2} \sin \frac{x}{n}, \quad -\infty < x < \infty.$$

**Example 4.4.18** The series

$$E(x) = \sum_{n=0}^{\infty} \frac{x^n}{n!} = 1 + x + \frac{x^2}{2!} + \frac{x^3}{3!} + \cdots \tag{4.4.26}$$

converges uniformly on every interval  $[-r, r]$  by Weierstrass's test, because

$$\frac{|x|^n}{n!} \leq \frac{r^n}{n!}, \quad |x| \leq r,$$

and

$$\sum \frac{r^n}{n!} < \infty$$

for all  $r$ , by the ratio test. Differentiating the right side of (4.4.26) term by term yields the series

$$\sum_{n=1}^{\infty} \frac{x^{n-1}}{(n-1)!} = \sum_{n=0}^{\infty} \frac{x^n}{n!},$$

which is the same as (4.4.26). Therefore, the differentiated series is also uniformly convergent on  $[-r, r]$  for every  $r$ , so the term by term differentiation is legitimate and

$$E'(x) = E(x), \quad -\infty < x < \infty.$$

This is not surprising if you recognize that  $E(x) = e^x$ .

**Example 4.4.19** Failure to verify that the given series converges at some point can lead to erroneous conclusions. For example, differentiating

$$\sum_{n=1}^{\infty} \cos \frac{x}{n} \tag{4.4.27}$$

term by term yields

$$-\sum_{n=1}^{\infty} \frac{1}{n} \sin \frac{x}{n},$$

which converges uniformly on  $[-r, r]$  for every  $r$ , since

$$\begin{aligned} \left| \frac{1}{n} \sin \frac{x}{n} \right| &\leq \frac{|x|}{n^2} \quad (\text{Exercise 2.3.19}) \\ &\leq \frac{r}{n^2} \quad \text{if } |x| \leq r, \end{aligned}$$

and  $\sum 1/n^2 < \infty$ . We cannot conclude from this that (4.4.27) converges uniformly on  $[-r, r]$ . In fact, it diverges for every  $x$ . (Why?)

#### 4.4 Exercises

---

- Find the set  $S$  on which  $\{F_n\}$  converges pointwise, and find the limit function.
  - $F_n(x) = x^n(1 - x^2)$
  - $F_n(x) = nx^n(1 - x^2)$

$$(c) F_n(x) = x^n(1 - x^n) \qquad (d) F_n(x) = \sin\left(1 + \frac{1}{n}\right)x$$

$$(e) F_n(x) = \frac{1 + x^n}{1 + x^{2n}} \qquad (f) F_n(x) = n \sin \frac{x}{n}$$

$$(g) F_n(x) = n^2 \left(1 - \cos \frac{x}{n}\right) \qquad (h) F_n(x) = nxe^{-nx^2}$$

$$(i) F_n(x) = \frac{(x + n)^2}{x^2 + n^2}$$

2. Prove: If  $\{F_n\}$  converges to  $F$  on  $[a, b]$  and  $F_n$  is nondecreasing for each  $n$ , then  $F$  is nondecreasing.
3. Show that the functions  $\{F_n\}$  of Example 4.4.4 are integrable and  $F = \lim_{n \rightarrow \infty} F_n(x)$  is nonintegrable on every finite interval.
4. Prove Lemma 4.4.2.
5. Find  $F(x) = \lim_{n \rightarrow \infty} F_n(x)$  on  $S$ . Show that  $\{F_n\}$  converges uniformly to  $F$  on closed subsets of  $S$ , but not on  $S$ .
  - (a)  $F_n(x) = x^n \sin nx$ ,  $S = (-1, 1)$
  - (b)  $F_n(x) = \frac{1}{1 + x^{2n}}$ ,  $S = \{x \mid x \neq \pm 1\}$
  - (c)  $F_n(x) = \frac{n^2 \sin x}{1 + n^2 x}$ ,  $S = (0, \infty)$  HINT: See Exercise 2.3.19.
6.
  - (a) Show that if  $\{F_n\}$  converges uniformly on  $S$ , then  $\{F_n\}$  converges uniformly on every subset of  $S$ .
  - (b) Show that if  $\{F_n\}$  converges uniformly on  $S_1, S_2, \dots, S_m$ , then  $\{F_n\}$  converges uniformly on  $\bigcup_{k=1}^m S_k$ .
  - (c) Give an example where  $\{F_n\}$  converges uniformly on each of an infinite sequence of sets  $S_1, S_2, \dots$ , but not on  $\bigcup_{k=1}^{\infty} S_k$ .
7. Describe the sets on which the sequences of Exercise 4.4.1 converge uniformly. Restrict your attention to sets that are the union of finitely many intervals and singleton sets.
8. Suppose that  $\{F_n\}$  converges pointwise on  $[a, b]$  and, for each  $x$  in  $[a, b]$ , there is an open interval  $I_x$  containing  $x$  such that  $\{F_n\}$  converges uniformly on  $I_x \cap [a, b]$ . Show that  $\{F_n\}$  converges uniformly on  $[a, b]$ .
9. Prove: If  $\{F_n\}$  converges uniformly to  $F$  on  $S$ , then  $\lim_{n \rightarrow \infty} \|F_n\|_S = \|F\|_S$ .
10. Prove: If  $\{F_n\}$  converges uniformly to  $F$  on  $S$ , then  $F$  is bounded on  $S$  if and only if  $\overline{\lim}_{n \rightarrow \infty} \{\|F_n\|_S\} < \infty$ .
11. Prove: If  $\{F_n\}$  and  $\{G_n\}$  converge uniformly to  $F$  and  $G$  on  $S$ , then  $\{F_n + G_n\}$  converges uniformly to  $F + G$  on  $S$ .
12.
  - (a) Prove: If  $\{F_n\}$  and  $\{G_n\}$  converge uniformly to bounded functions  $F$  and  $G$  on  $S$ , then  $\{F_n G_n\}$  converges uniformly to  $FG$  on  $S$ .

- (b) Give an example showing that the conclusion of (a) may fail to hold if  $F$  or  $G$  is unbounded on  $S$ .
13. (a) Suppose that  $\{F_n\}$  converges uniformly to  $F$  on  $(a, b)$ . Prove: If  $x_0 < a < b$  and  $L_n = \lim_{x \rightarrow x_0} F_n(x)$  exists (finite) for every  $n$ , then  $L = \lim_{n \rightarrow \infty} L_n$  exists (finite) and

$$\lim_{x \rightarrow x_0} F(x) = L.$$

- (b) State similar results for limits from the right and left.
14. Find the limits.
- (a)  $\lim_{n \rightarrow \infty} \int_1^4 \frac{n}{x} \sin \frac{x}{n} dx$                       (b)  $\lim_{n \rightarrow \infty} \int_0^2 \frac{dx}{1 + x^{2n}}$
- (c)  $\lim_{n \rightarrow \infty} \int_0^1 n x e^{-n x^2} dx$                       (d)  $\lim_{n \rightarrow \infty} \int_0^1 \left(1 + \frac{x}{n}\right)^n dx$
15. Prove (without using Theorem 4.4.10): If each  $F_n$  is integrable and  $\{F_n\}$  converges uniformly on  $[a, b]$ , then  $\lim_{n \rightarrow \infty} \int_a^b F_n(x) dx$  exists.
16. Prove (without using Theorem 4.4.10): If each  $F_n$  is nondecreasing and  $\{F_n\}$  converges uniformly to  $F$  on  $[a, b]$ , then

$$\lim_{n \rightarrow \infty} \int_a^b F_n(x) dx = \int_a^b F(x) dx.$$

17. Use Weierstrass's test to determine sets on which the series converges absolutely uniformly.
- (a)  $\sum \frac{1}{n^{1/2}} \left(\frac{x}{1+x}\right)^n$                       (b)  $\sum \frac{1}{n^{3/2}} \left(\frac{x}{1+x}\right)^n$
- (c)  $\sum n x^n (1-x)^n$                       (d)  $\sum \frac{1}{n(x^2+n)}$
- (e)  $\sum \frac{1}{n^x}$                       (f)  $\sum \frac{(1-x^2)^n}{(1+x^2)^n} \sin nx$
18. Show that if  $\sum |a_n| < \infty$ , then  $\sum a_n \cos nx$  and  $\sum a_n \sin nx$  define continuous functions on  $(-\infty, \infty)$ .
19. (a) Give an example showing that the following "comparison test" is invalid: If  $\sum f_n$  converges uniformly on  $S$  and  $\|g_n\|_S \leq \|f_n\|_S$ , then  $\sum g_n$  converges uniformly on  $S$ .
- (b) This "comparison test" can be corrected by adding one word to its hypothesis and conclusion. What is the word?
20. (a) Explain the difference between the following statements: (i)  $\sum f_n$  converges absolutely and uniformly on  $S$ ; (ii)  $\sum f_n$  converges absolutely uniformly on  $S$ .



- (b) Show that if  $\sum f_n$  converges absolutely uniformly on  $S$ , then  $\sum f_n$  converges uniformly on  $S$ .
21. Show that the hypotheses of Weierstrass's test imply that  $\sum f_n$  converges absolutely uniformly on  $S$ .
22. Prove Corollary 4.4.17.
23. Prove Theorem 4.4.18.
24. Suppose that  $\{a_n\}_1^\infty$  is monotonic and  $\lim_{n \rightarrow \infty} a_n = 0$ . Show that

$$\sum_{n=1}^{\infty} a_n \sin nx \quad \text{and} \quad \sum_{n=1}^{\infty} a_n \cos nx$$

define functions continuous for all  $x \neq 2k\pi$  ( $k = \text{integer}$ ).

25. Prove Theorem 4.4.19.
26. Formulate an analog of Theorem 4.4.10 for series.
27. In Section 4.5 we will see that

$$e^{-x^2} = \sum_{n=0}^{\infty} (-1)^n \frac{x^{2n}}{n!} \quad \text{and} \quad \sin x = \sum_{n=0}^{\infty} (-1)^n \frac{x^{2n+1}}{(2n+1)!}$$

for all  $x$ , and in both cases the convergence is uniform on every finite interval. Find series that converge to

$$(a) \quad F(x) = \int_0^x e^{-t^2} dt \quad \text{and} \quad (b) \quad G(x) = \int_0^x \frac{\sin t}{t} dt$$

for all  $x$ .

28. Prove Theorem 4.4.20.
29. Show from Example 4.4.17 that  $\sum_{n=1}^{\infty} (-1)^n \sin(x/n)$  converges uniformly on any finite interval.
30. Prove: If  $0 < a_{n+1} < a_n$  and  $\sum a_n^k < \infty$  for some positive integer  $k$ , then  $\sum (-1)^n \sin a_n x$  converges uniformly on any finite interval.
31. For  $n \geq 2$ , define

$$f_n(x) = \begin{cases} n^4(x - n + 1/n^3), & n - 1/n^3 \leq x \leq n, \\ -n^4(x - n - 1/n^3), & n \leq x \leq n + 1/n^3, \\ 0, & |x - n| > 1/n^3, \end{cases}$$

and let  $F(x) = \sum_{n=2}^{\infty} f_n(x)$ . Show that  $\int_0^{\infty} F(x) dx < \infty$ , and conclude that absolute convergence of an improper integral  $\int_0^{\infty} F(x) dx$  does not imply that  $\lim_{n \rightarrow \infty} F(x) = 0$ , even if  $F$  is continuous on  $[0, \infty)$ .

## 4.5 POWER SERIES

We now consider a class of series sufficiently general to be interesting, but sufficiently specialized to be easily understood.

**Definition 4.5.1** An infinite series of the form

$$\sum_{n=0}^{\infty} a_n (x - x_0)^n, \quad (4.5.1)$$

where  $x_0$  and  $a_0, a_1, \dots$ , are constants, is called a *power series in  $x - x_0$* . ■

The following theorem summarizes the convergence properties of power series.

**Theorem 4.5.2** In connection with the power series (4.5.1), define  $R$  in the extended reals by

$$\frac{1}{R} = \overline{\lim}_{n \rightarrow \infty} |a_n|^{1/n}. \quad (4.5.2)$$

In particular,  $R = 0$  if  $\overline{\lim}_{n \rightarrow \infty} |a_n|^{1/n} = \infty$ , and  $R = \infty$  if  $\overline{\lim}_{n \rightarrow \infty} |a_n|^{1/n} = 0$ . Then the power series converges

- (a) only for  $x = x_0$  if  $R = 0$ ;
- (b) for all  $x$  if  $R = \infty$ , and absolutely uniformly in every bounded set;
- (c) for  $x$  in  $(x_0 - R, x_0 + R)$  if  $0 < R < \infty$ , and absolutely uniformly in every closed subset of this interval.

The series diverges if  $|x - x_0| > R$ . No general statement can be made concerning convergence at the endpoints  $x = x_0 + R$  and  $x = x_0 - R$ : the series may converge absolutely or conditionally at both, converge conditionally at one and diverge at the other, or diverge at both.

**Proof** In any case, the series (4.5.1) converges to  $a_0$  if  $x = x_0$ . If

$$\sum |a_n| r^n < \infty \quad (4.5.3)$$

for some  $r > 0$ , then  $\sum a_n (x - x_0)^n$  converges absolutely uniformly in  $[x_0 - r, x_0 + r]$ , by Weierstrass's test (Theorem 4.4.15) and Exercise 4.4.21. From Cauchy's root test (Theorem 4.3.17), (4.5.3) holds if

$$\overline{\lim}_{n \rightarrow \infty} (|a_n| r^n)^{1/n} < 1,$$

which is equivalent to

$$r \overline{\lim}_{n \rightarrow \infty} |a_n|^{1/n} < 1$$

(Exercise 4.1.30(a)). From (4.5.2), this can be rewritten as  $r < R$ , which proves the assertions concerning convergence in (b) and (c).

If  $0 \leq R < \infty$  and  $|x - x_0| > R$ , then

$$\frac{1}{R} > \frac{1}{|x - x_0|},$$

so (4.5.2) implies that

$$|a_n|^{1/n} \geq \frac{1}{|x - x_0|} \quad \text{and therefore} \quad |a_n(x - x_0)^n| \geq 1$$

for infinitely many values of  $n$ . Therefore,  $\sum a_n(x - x_0)^n$  diverges (Corollary 4.3.6) if  $|x - x_0| > R$ . In particular, the series diverges for all  $x \neq x_0$  if  $R = 0$ .

To prove the assertions concerning the possibilities at  $x = x_0 + R$  and  $x = x_0 - R$  requires examples, which follow. (Also, see Exercise 4.5.1.) ■

The number  $R$  defined by (4.5.2) is the *radius of convergence* of  $\sum a_n(x - x_0)^n$ . If  $R > 0$ , the *open* interval  $(x_0 - R, x_0 + R)$ , or  $(-\infty, \infty)$  if  $R = \infty$ , is the *interval of convergence* of the series. Theorem 4.5.2 says that a power series with a nonzero radius of convergence converges absolutely uniformly in every compact subset of its interval of convergence and diverges at every point in the exterior of this interval. On this last we can make a stronger statement: Not only does  $\sum a_n(x - x_0)^n$  diverge if  $|x - x_0| > R$ , but the sequence  $\{a_n(x - x_0)^n\}$  is unbounded in this case (Exercise 4.5.3(b)).

**Example 4.5.1** For the series

$$\sum \frac{\sin n\pi/6}{2^n} (x - 1)^n,$$

we have

$$\begin{aligned} \overline{\lim}_{n \rightarrow \infty} |a_n|^{1/n} &= \overline{\lim}_{n \rightarrow \infty} \left( \frac{|\sin n\pi/6|}{2^n} \right)^{1/n} \\ &= \frac{1}{2} \overline{\lim}_{n \rightarrow \infty} (|\sin n\pi/6|)^{1/n} \quad (\text{Exercise 4.1.30(a)}) \\ &= \frac{1}{2}(1) = \frac{1}{2}. \end{aligned}$$

Therefore,  $R = 2$  and Theorem 4.5.2 implies that the series converges absolutely uniformly in closed subintervals of  $(-1, 3)$  and diverges if  $x < -1$  or  $x > 3$ . Theorem 4.5.2 does not tell us what happens when  $x = -1$  or  $x = 3$ , but we can see that the series diverges in both these cases since its general term does not approach zero.

**Example 4.5.2** For the series

$$\sum \frac{x^n}{n},$$

$$\overline{\lim}_{n \rightarrow \infty} |a_n|^{1/n} = \overline{\lim}_{n \rightarrow \infty} \left( \frac{1}{n} \right)^{1/n} = \overline{\lim}_{n \rightarrow \infty} \exp \left( \frac{1}{n} \log \frac{1}{n} \right) = e^0 = 1.$$

Therefore,  $R = 1$  and the series converges absolutely uniformly in closed subintervals of  $(-1, 1)$  and diverges if  $|x| > 1$ . For  $x = -1$  the series becomes  $\sum (-1)^n/n$ , which converges conditionally, and at  $x = 1$  the series becomes  $\sum 1/n$ , which diverges. ■

The next theorem provides an expression for  $R$  that, if applicable, is usually easier to use than (4.5.2).

**Theorem 4.5.3** *The radius of convergence of  $\sum a_n(x - x_0)^n$  is given by*

$$\frac{1}{R} = \lim_{n \rightarrow \infty} \left| \frac{a_{n+1}}{a_n} \right|$$

if the limit exists in the extended reals.

**Proof** From Theorem 4.5.2, it suffices to show that if

$$L = \lim_{n \rightarrow \infty} \left| \frac{a_{n+1}}{a_n} \right| \quad (4.5.4)$$

exists in the extended reals, then

$$L = \overline{\lim}_{n \rightarrow \infty} |a_n|^{1/n}. \quad (4.5.5)$$

We will show that this is so if  $0 < L < \infty$  and leave the cases where  $L = 0$  or  $L = \infty$  to you (Exercise 4.5.7).

If (4.5.4) holds with  $0 < L < \infty$  and  $0 < \epsilon < L$ , there is an integer  $N$  such that

$$L - \epsilon < \left| \frac{a_{m+1}}{a_m} \right| < L + \epsilon \quad \text{if } m \geq N,$$

so

$$|a_m|(L - \epsilon) < |a_{m+1}| < |a_m|(L + \epsilon) \quad \text{if } m \geq N.$$

By induction,

$$|a_N|(L - \epsilon)^{n-N} < |a_n| < |a_N|(L + \epsilon)^{n-N} \quad \text{if } n > N.$$

Therefore, if

$$K_1 = |a_N|(L - \epsilon)^{-N} \quad \text{and} \quad K_2 = |a_N|(L + \epsilon)^{-N},$$

then

$$K_1^{1/n}(L - \epsilon) < |a_n|^{1/n} < K_2^{1/n}(L + \epsilon). \quad (4.5.6)$$

Since  $\lim_{n \rightarrow \infty} K^{1/n} = 1$  if  $K$  is any positive number, (4.5.6) implies that

$$L - \epsilon \leq \underline{\lim}_{n \rightarrow \infty} |a_n|^{1/n} \leq \overline{\lim}_{n \rightarrow \infty} |a_n|^{1/n} \leq L + \epsilon.$$

Since  $\epsilon$  is an arbitrary positive number, it follows that

$$\lim_{n \rightarrow \infty} |a_n|^{1/n} = L,$$

which implies (4.5.5). ■

**Example 4.5.3** For the power series

$$\sum \frac{x^n}{n!},$$

$$\lim_{n \rightarrow \infty} \left| \frac{a_{n+1}}{a_n} \right| = \lim_{n \rightarrow \infty} \frac{n!}{(n+1)!} = \lim_{n \rightarrow \infty} \frac{1}{n+1} = 0.$$

Therefore,  $R = \infty$ ; that is, the series converges for all  $x$ , and absolutely uniformly in every bounded set.

**Example 4.5.4** For the power series

$$\sum n!x^n,$$

$$\lim_{n \rightarrow \infty} \left| \frac{a_{n+1}}{a_n} \right| = \lim_{n \rightarrow \infty} \frac{(n+1)!}{n!} = \lim_{n \rightarrow \infty} (n+1) = \infty.$$

Therefore,  $R = 0$ , and the series converges only if  $x = 0$ .

**Example 4.5.5** Theorem 4.5.3 does not apply directly to

$$\sum \frac{(-1)^n}{4^n n^p} x^{2n} \quad (p = \text{constant}), \quad (4.5.7)$$

which has infinitely many zero coefficients (of odd powers of  $x$ ). However, by setting  $y = x^2$ , we obtain the series

$$\sum \frac{(-1)^n}{4^n n^p} y^n, \quad (4.5.8)$$

which has nonzero coefficients for which

$$\lim_{n \rightarrow \infty} \left| \frac{a_{n+1}}{a_n} \right| = \lim_{n \rightarrow \infty} \frac{4^n n^p}{4^{n+1} (n+1)^p} = \frac{1}{4} \lim_{n \rightarrow \infty} \left( 1 + \frac{1}{n} \right)^{-p} = \frac{1}{4}.$$

Therefore, (4.5.8) converges if  $|y| < 4$  and diverges if  $|y| > 4$ . Setting  $y = x^2$ , we conclude that (4.5.7) converges if  $|x| < 2$  and diverges if  $|x| > 2$ . At  $x = \pm 2$ , (4.5.7) becomes  $\sum (-1)^n / n^p$ , which diverges if  $p \leq 0$ , converges conditionally if  $0 < p \leq 1$ , and converges absolutely if  $p > 1$ .

## Properties of Functions Defined by Power Series

We now study the properties of functions defined by power series. Henceforth, we consider only power series with nonzero radii of convergence.

**Theorem 4.5.4** *A power series*

$$f(x) = \sum_{n=0}^{\infty} a_n (x - x_0)^n$$

with positive radius of convergence  $R$  is continuous and differentiable in its interval of convergence, and its derivative can be obtained by differentiating term by term; that is,

$$f'(x) = \sum_{n=1}^{\infty} n a_n (x - x_0)^{n-1}, \quad (4.5.9)$$

which can also be written as

$$f'(x) = \sum_{n=0}^{\infty} (n+1) a_{n+1} (x - x_0)^n. \quad (4.5.10)$$

This series also has radius of convergence  $R$ .

**Proof** First, the series in (4.5.9) and (4.5.10) are the same, since the latter is obtained by shifting the index of summation in the former. Since

$$\begin{aligned} \overline{\lim}_{n \rightarrow \infty} ((n+1)|a_n|)^{1/n} &= \overline{\lim}_{n \rightarrow \infty} (n+1)^{1/n} |a_n|^{1/n} \\ &= \left( \lim_{n \rightarrow \infty} (n+1)^{1/n} \right) \left( \overline{\lim}_{n \rightarrow \infty} |a_n|^{1/n} \right) \quad (\text{Exercise 4.1.30(a)}) \\ &= \left[ \lim_{n \rightarrow \infty} \exp\left(\frac{\log(n+1)}{n}\right) \right] \left( \overline{\lim}_{n \rightarrow \infty} |a_n|^{1/n} \right) = \frac{e^0}{R} = \frac{1}{R}, \end{aligned}$$

the radius of convergence of the power series in (4.5.10) is  $R$  (Theorem 4.5.2). Therefore, the power series in (4.5.10) converges uniformly in every interval  $[x_0 - r, x_0 + r]$  such that  $0 < r < R$ , and Theorem 4.4.20 now implies (4.5.10) for all  $x$  in  $(x_0 - R, x_0 + R)$ . ■

Theorem 4.5.4 can be strengthened as follows.

**Theorem 4.5.5** *A power series*

$$f(x) = \sum_{n=0}^{\infty} a_n (x - x_0)^n$$

with positive radius of convergence  $R$  has derivatives of all orders in its interval of convergence, which can be obtained by repeated term by term differentiation; thus,

$$f^{(k)}(x) = \sum_{n=k}^{\infty} n(n-1)\cdots(n-k+1) a_n (x - x_0)^{n-k}. \quad (4.5.11)$$

The radius of convergence of each of these series is  $R$ .

**Proof** The proof is by induction. The assertion is true for  $k = 1$ , by Theorem 4.5.4. Suppose that it is true for some  $k \geq 1$ . By shifting the index of summation, we can rewrite (4.5.11) as

$$f^{(k)}(x) = \sum_{n=0}^{\infty} (n+k)(n+k-1)\cdots(n+1) a_{n+k} (x - x_0)^n, \quad |x - x_0| < R.$$

Defining

$$b_n = (n+k)(n+k-1)\cdots(n+1)a_{n+k}, \quad (4.5.12)$$

we rewrite this as

$$f^{(k)}(x) = \sum_{n=0}^{\infty} b_n(x-x_0)^n, \quad |x-x_0| < R.$$

By Theorem 4.5.4, we can differentiate this series term by term to obtain

$$f^{(k+1)}(x) = \sum_{n=1}^{\infty} n b_n(x-x_0)^{n-1}, \quad |x-x_0| < R.$$

Substituting from (4.5.12) for  $b_n$  yields

$$f^{(k+1)}(x) = \sum_{n=1}^{\infty} (n+k)(n+k-1)\cdots(n+1)n a_{n+k}(x-x_0)^{n-1}, \quad |x-x_0| < R.$$

Shifting the summation index yields

$$f^{(k+1)}(x) = \sum_{n=k+1}^{\infty} n(n-1)\cdots(n-k)a_n(x-x_0)^{n-k-1}, \quad |x-x_0| < R,$$

which is (4.5.11) with  $k$  replaced by  $k+1$ . This completes the induction. ■

**Example 4.5.6** In Example 4.4.10 we saw that

$$\frac{1}{1-x} = \sum_{n=0}^{\infty} x^n, \quad |x| < 1.$$

Repeated differentiation yields

$$\begin{aligned} \frac{k!}{(1-x)^{k+1}} &= \sum_{n=k}^{\infty} n(n-1)\cdots(n-k+1)x^{n-k} \\ &= \sum_{n=0}^{\infty} (n+k)(n+k-1)\cdots(n+1)x^n, \quad |x| < 1, \end{aligned}$$

so

$$\frac{1}{(1-x)^{k+1}} = \sum_{n=0}^{\infty} \binom{n+k}{k} x^n, \quad |x| < 1.$$

**Example 4.5.7** By the method of Example 4.5.5, it can be shown that the series

$$S(x) = \sum_{n=0}^{\infty} (-1)^n \frac{x^{2n+1}}{(2n+1)!} \quad \text{and} \quad C(x) = \sum_{n=0}^{\infty} (-1)^n \frac{x^{2n}}{(2n)!}$$

converge for all  $x$ . Differentiating yields

$$S'(x) = \sum_{n=0}^{\infty} (-1)^n \frac{x^n}{(2n)!} = C(x)$$

and

$$C'(x) = \sum_{n=1}^{\infty} (-1)^n \frac{x^{2n-1}}{(2n-1)!} = - \sum_{n=0}^{\infty} (-1)^n \frac{x^{2n+1}}{(2n+1)!} = -S(x).$$

These results should not surprise you if you recall that

$$S(x) = \sin x \quad \text{and} \quad C(x) = \cos x.$$

(We will soon prove this.) ■

Theorem 4.5.5 has two important corollaries.

**Corollary 4.5.6** *If*

$$f(x) = \sum_{n=0}^{\infty} a_n (x - x_0)^n, \quad |x - x_0| < R,$$

*then*

$$a_n = \frac{f^{(n)}(x_0)}{n!}.$$

**Proof** Setting  $x = x_0$  in (4.5.11) yields

$$f^{(k)}(x_0) = k! a_k. \quad \blacksquare$$

**Corollary 4.5.7 (Uniqueness of Power Series)** *If*

$$\sum_{n=0}^{\infty} a_n (x - x_0)^n = \sum_{n=0}^{\infty} b_n (x - x_0)^n \quad (4.5.13)$$

*for all  $x$  in some interval  $(x_0 - r, x_0 + r)$ , then*

$$a_n = b_n, \quad n \geq 0. \quad (4.5.14)$$

**Proof** Let

$$f(x) = \sum_{n=0}^{\infty} a_n (x - x_0)^n \quad \text{and} \quad g(x) = \sum_{n=0}^{\infty} b_n (x - x_0)^n.$$

From Corollary 4.5.6,

$$a_n = \frac{f^{(n)}(x_0)}{n!} \quad \text{and} \quad b_n = \frac{g^{(n)}(x_0)}{n!}. \quad (4.5.15)$$



From (4.5.13),  $f = g$  in  $(x_0 - r, x_0 + r)$ . Therefore,

$$f^{(n)}(x_0) = g^{(n)}(x_0), \quad n \geq 0.$$

This and (4.5.15) imply (4.5.14). ■

Theorems 4.4.19 and 4.5.2 imply the following theorem. We leave the proof to you (Exercise 4.5.15).

**Theorem 4.5.8** *If  $x_1$  and  $x_2$  are in the interval of convergence of*

$$f(x) = \sum_{n=0}^{\infty} a_n(x - x_0)^n,$$

*then*

$$\int_{x_1}^{x_2} f(x) dx = \sum_{n=0}^{\infty} \frac{a_n}{n+1} [(x_2 - x_0)^{n+1} - (x_1 - x_0)^{n+1}];$$

*that is, a power series may be integrated term by term between any two points in its interval of convergence.*

Example 4.5.16 presents an application of this theorem.

## Taylor's Series

So far we have asked for what values of  $x$  a given power series converges, and what are the properties of its sum. Now we ask a related question: What properties guarantee that a given function  $f$  can be represented as the sum of a convergent power series in  $x - x_0$ ? A partial answer to this question is provided by what we already know: Theorem 4.5.5 tells us that  $f$  must have derivatives of all orders in some neighborhood of  $x_0$ , and Corollary 4.5.6 tells us that the only power series in  $x - x_0$  that can possibly converge to  $f$  in such a neighborhood is

$$\sum_{n=0}^{\infty} \frac{f^{(n)}(x_0)}{n!} (x - x_0)^n. \quad (4.5.16)$$

This is called the *Taylor series of  $f$  about  $x_0$*  (also, the *Maclaurin series* of  $f$ , if  $x_0 = 0$ ). The  $m$ th partial sum of (4.5.16) is the Taylor polynomial

$$T_m(x) = \sum_{n=0}^m \frac{f^{(n)}(x_0)}{n!} (x - x_0)^n,$$

defined in Section 2.5.

The Taylor series of an infinitely differentiable function  $f$  may converge to a sum different from  $f$ . For example, the function

$$f(x) = \begin{cases} e^{-1/x^2}, & x \neq 0, \\ 0, & x = 0, \end{cases}$$

is infinitely differentiable on  $(-\infty, \infty)$  and  $f^{(n)}(0) = 0$  for  $n \geq 0$  (Exercise 2.5.1), so its Maclaurin series is identically zero.

The answer to our question is provided by Taylor's theorem (Theorem 2.5.4), which says that if  $f$  is infinitely differentiable on  $(a, b)$  and  $x$  and  $x_0$  are in  $(a, b)$  then, for every integer  $n \geq 0$ ,

$$f(x) - T_n(x) = \frac{f^{(n+1)}(c_n)}{(n+1)!} (x - x_0)^{n+1}, \quad (4.5.17)$$

where  $c_n$  is between  $x$  and  $x_0$ . Therefore,

$$f(x) = \sum_{n=0}^{\infty} \frac{f^{(n)}(x_0)}{n!} (x - x_0)^n$$

for an  $x$  in  $(a, b)$  if and only if

$$\lim_{n \rightarrow \infty} \frac{f^{(n+1)}(c_n)}{(n+1)!} (x - x_0)^{n+1} = 0.$$

It is not always easy to check this condition, because the sequence  $\{c_n\}$  is usually not precisely known, or even uniquely defined; however, the next theorem is sufficiently general to be useful.

**Theorem 4.5.9** Suppose that  $f$  is infinitely differentiable on an interval  $I$  and

$$\lim_{n \rightarrow \infty} \frac{r^n}{n!} \|f^{(n)}\|_I = 0. \quad (4.5.18)$$

Then, if  $x_0 \in I^0$ , the Taylor series

$$\sum_{n=0}^{\infty} \frac{f^{(n)}(x_0)}{n!} (x - x_0)^n$$

converges uniformly to  $f$  on

$$I_r = I \cap [x_0 - r, x_0 + r].$$

**Proof** From (4.5.17),

$$\|f - T_n\|_{I_r} \leq \frac{r^{n+1}}{(n+1)!} \|f^{(n+1)}\|_{I_r} \leq \frac{r^{n+1}}{(n+1)!} \|f^{(n+1)}\|_I,$$

so (4.5.18) implies the conclusion. ■

**Example 4.5.8** If  $f(x) = \sin x$ , then  $\|f^{(k)}\|_{(-\infty, \infty)} = 1$ ,  $k \geq 0$ . Since

$$\lim_{n \rightarrow \infty} \frac{r^n}{n!} = 0, \quad 0 < r < \infty$$

(Example 4.1.12), (4.5.18) holds for all  $r$ . Since

$$f^{(2m)}(0) = 0 \quad \text{and} \quad f^{(2m+1)}(0) = (-1)^m, \quad m \geq 0,$$

we see from Theorem 4.5.9, with  $I = (-\infty, \infty)$ ,  $x_0 = 0$ , and  $r$  arbitrary, that

$$\sin x = \sum_{n=0}^{\infty} (-1)^n \frac{x^{2n+1}}{(2n+1)!}, \quad -\infty < x < \infty,$$

and the convergence is uniform on bounded sets.

A similar argument shows that

$$\cos x = \sum_{n=0}^{\infty} (-1)^n \frac{x^{2n}}{(2n)!}, \quad -\infty < x < \infty,$$

with uniform convergence on bounded sets.

**Example 4.5.9** If  $f(x) = e^x$ , then  $f^{(k)}(x) = e^x$  and  $\|f^{(k)}\|_I = e^r$ ,  $k \geq 0$ , if  $I = [-r, r]$ . Since

$$\lim_{n \rightarrow \infty} \frac{r^n}{n!} e^r = 0,$$

we conclude as in Example 4.5.8 that

$$e^x = \sum_{n=0}^{\infty} \frac{x^n}{n!}, \quad -\infty < x < \infty,$$

with uniform convergence on bounded sets.

**Example 4.5.10** If  $f(x) = (1+x)^q$ , then

$$\frac{f^{(n)}(x)}{n!} = \binom{q}{n} (1+x)^{q-n}, \quad \text{so} \quad \frac{f^{(n)}(0)}{n!} = \binom{q}{n} \quad (4.5.19)$$

(Example 2.5.3). The Maclaurin series

$$\sum_{n=0}^{\infty} \binom{q}{n} x^n$$

is called the *binomial series*. We saw in Example 2.5.3 that this series equals  $(1+x)^q$  for all  $x$  if  $q$  is a nonnegative integer. We will now show that if  $q$  is an arbitrary real number, then

$$\sum_{n=0}^{\infty} \binom{q}{n} x^n = f(x) = (1+x)^q, \quad 0 \leq x < 1. \quad (4.5.20)$$

Since

$$\lim_{n \rightarrow \infty} \left| \binom{q}{n+1} / \binom{q}{n} \right| = \lim_{n \rightarrow \infty} \left| \frac{q-n}{n+1} \right| = 1,$$

the radius of convergence of the series in (4.5.20) is 1. From (4.5.19),

$$\frac{\|f^{(n)}\|_{[0,1]}}{n!} \leq [\max(1, 2^q)] \left| \binom{q}{n} \right|, \quad n \geq 0.$$

Therefore, if  $0 < r < 1$ ,

$$\overline{\lim}_{n \rightarrow \infty} \frac{r^n}{n!} \|f^{(n)}\|_{[0,1]} \leq [\max(1, 2^q)] \lim_{n \rightarrow \infty} \left| \binom{q}{n} \right| r^n = 0,$$

where the last equality follows from the absolute convergence of the series in (4.5.20) on  $(-1, 1)$ . Now Theorem 4.5.9 implies (4.5.20). ■

We cannot prove in this way that the binomial series converges to  $(1+x)^q$  on  $(-1, 0)$ . This requires a form of the remainder in Taylor's theorem that we have not considered, or a different kind of proof altogether (Exercise 4.5.20). The complete result is that

$$(1+x)^q = \sum_{n=0}^{\infty} \binom{q}{n} x^n, \quad -1 < x < 1, \quad (4.5.21)$$

for all  $q$ , and, as we said earlier, the identity holds for all  $x$  if  $q$  is a nonnegative integer.

### Arithmetic Operations with Power Series

We now consider addition and multiplication of power series, and division of one by another.

We leave the proof of the next theorem to you (Exercise 4.5.21).

**Theorem 4.5.10** *If*

$$f(x) = \sum_{n=0}^{\infty} a_n (x-x_0)^n, \quad |x-x_0| < R_1, \quad (4.5.22)$$

$$g(x) = \sum_{n=0}^{\infty} b_n (x-x_0)^n, \quad |x-x_0| < R_2, \quad (4.5.23)$$

and  $\alpha$  and  $\beta$  are constants, then

$$\alpha f(x) + \beta g(x) = \sum_{n=0}^{\infty} (\alpha a_n + \beta b_n) (x-x_0)^n, \quad |x-x_0| < R,$$

where  $R \geq \min\{R_1, R_2\}$ .

**Theorem 4.5.11** If  $f$  and  $g$  are given by (4.5.22) and (4.5.23), then

$$f(x)g(x) = \sum_{n=0}^{\infty} c_n(x-x_0)^n, \quad |x-x_0| < R, \quad (4.5.24)$$

where

$$c_n = \sum_{r=0}^n a_r b_{n-r} = \sum_{r=0}^n a_{n-r} b_r$$

and  $R \geq \min\{R_1, R_2\}$ .

**Proof** Suppose that  $R_1 \leq R_2$ . Since the series (4.5.22) and (4.5.23) converge absolutely to  $f(x)$  and  $g(x)$  if  $|x-x_0| < R_1$ , their Cauchy product converges to  $f(x)g(x)$  if  $|x-x_0| < R_1$ , by Theorem 4.3.29. The  $n$ th term of this product is

$$\sum_{r=0}^n a_r(x-x_0)^r b_{n-r}(x-x_0)^{n-r} = \left( \sum_{r=0}^n a_r b_{n-r} \right) (x-x_0)^n = c_n(x-x_0)^n. \quad \blacksquare$$

**Example 4.5.11** If

$$f(x) = \frac{1}{1-x} = \sum_{n=0}^{\infty} x^n, \quad |x| < 1,$$

and

$$g(x) = \sum_{n=0}^{\infty} b_n x^n, \quad |x| < R,$$

then

$$\frac{g(x)}{1-x} = \sum_{n=0}^{\infty} s_n x^n, \quad |x| < \min\{1, R\},$$

where

$$\begin{aligned} s_n &= (1)b_0 + (1)b_1 + \cdots + (1)b_n \\ &= b_0 + b_1 + \cdots + b_n. \end{aligned}$$

**Example 4.5.12** From the paragraph following Example 4.5.10,

$$(1+x)^p = \sum_{n=0}^{\infty} \binom{p}{n} x^n, \quad |x| < 1,$$

and

$$(1+x)^q = \sum_{n=0}^{\infty} \binom{q}{n} x^n, \quad |x| < 1.$$

Since

$$(1+x)^p(1+x)^q = (1+x)^{p+q} = \sum_{n=0}^{\infty} \binom{p+q}{n} x^n,$$

while the Cauchy product is  $\sum_{n=0}^{\infty} c_n x^n$ , with

$$c_n = \sum_{r=0}^n \binom{p}{r} \binom{q}{n-r},$$

Corollary 4.5.7 implies that

$$c_n = \binom{p+q}{n}.$$

This yields the identity

$$\binom{p+q}{n} = \sum_{r=0}^n \binom{p}{r} \binom{q}{n-r},$$

valid for all  $p$  and  $q$ . ■

The quotient

$$f(x) = \frac{h(x)}{g(x)} \tag{4.5.25}$$

of two power series

$$h(x) = \sum_{n=0}^{\infty} c_n (x-x_0)^n, \quad |x-x_0| < R_1,$$

and

$$g(x) = \sum_{n=0}^{\infty} b_n (x-x_0)^n, \quad |x-x_0| < R_2,$$

can be represented as a power series

$$f(x) = \sum_{n=0}^{\infty} a_n (x-x_0)^n \tag{4.5.26}$$

with a positive radius of convergence, provided that

$$b_0 = g(x_0) \neq 0.$$

This is surely plausible. Since  $g(x_0) \neq 0$  and  $g$  is continuous near  $x_0$ , the denominator of (4.5.25) differs from zero on an interval about  $x_0$ . Therefore,  $f$  has derivatives of all orders on this interval, because  $g$  and  $h$  do. However, the proof that the Taylor series of  $f$  about  $x_0$  converges to  $f$  near  $x_0$  requires the use of the theory of functions of a complex variable. Therefore, we omit it. However, it is straightforward to compute the coefficients in (4.5.26) if we accept the validity of the expansion. Since

$$f(x)g(x) = h(x),$$

Theorem 4.5.11 implies that

$$\sum_{r=0}^n a_r b_{n-r} = c_n, \quad n \geq 0.$$

Solving these equations successively yields

$$a_0 = \frac{c_0}{b_0},$$

$$a_n = \frac{1}{b_0} \left( c_n - \sum_{r=0}^{n-1} b_{n-r} a_r \right), \quad n \geq 1.$$

It is not worthwhile to memorize these formulas. Rather, it is usually better to view the procedure as follows: Multiply the series  $f$  (with unknown coefficients) and  $g$  according to the procedure of Theorem 4.5.11, equate the resulting coefficients with those of  $h$ , and solve the resulting equations successively for  $a_0, a_1, \dots$ .

**Example 4.5.13** Suppose that we wish to find the coefficients in the Maclaurin series

$$\tan x = a_0 + a_1 x + a_2 x^2 + \dots.$$

We first observe that since  $\tan x$  is an odd function, its derivatives of even order vanish at  $x_0 = 0$ , so  $a_{2m} = 0, m \geq 0$ . Therefore,

$$\tan x = a_1 x + a_3 x^3 + a_5 x^5 + \dots.$$

Since

$$\tan x = \frac{\sin x}{\cos x},$$

it follows from Example 4.5.8 that

$$a_1 x + a_3 x^3 + a_5 x^5 + \dots = \frac{x - \frac{x^3}{6} + \frac{x^5}{120} + \dots}{1 - \frac{x^2}{2} + \frac{x^4}{24} + \dots}$$

so

$$(a_1 x + a_3 x^3 + a_5 x^5 + \dots) \left( 1 - \frac{x^2}{2} + \frac{x^4}{24} + \dots \right) = x - \frac{x^3}{6} + \frac{x^5}{120} + \dots,$$

or, according to Theorem 4.5.11,

$$a_1 x + \left( a_3 - \frac{a_1}{2} \right) x^3 + \left( a_5 - \frac{a_3}{2} + \frac{a_1}{24} \right) x^5 + \dots = x - \frac{x^3}{6} + \frac{x^5}{120} + \dots.$$

From Corollary 4.5.7, coefficients of like powers of  $x$  on the two sides of this equation must be equal; hence,

$$a_1 = 1, \quad a_3 - \frac{a_1}{2} = -\frac{1}{6}, \quad a_5 - \frac{a_3}{2} + \frac{a_1}{24} = \frac{1}{120},$$

so

$$a_1 = 1, \quad a_3 = -\frac{1}{6} + \frac{1}{2}(1) = \frac{1}{3}, \quad a_5 = \frac{1}{120} + \frac{1}{2} \left( \frac{1}{3} \right) - \frac{1}{24}(1) = \frac{2}{15}.$$

Therefore,

$$\tan x = x + \frac{x^3}{3} + \frac{2}{15}x^5 + \cdots.$$

**Example 4.5.14** To find the reciprocal of the power series

$$g(x) = 1 + e^x = 2 + \sum_{n=1}^{\infty} \frac{x^n}{n!},$$

we let  $h = 1$  in (4.5.25). If

$$\frac{1}{g(x)} = \sum_{n=0}^{\infty} a_n x^n,$$

then

$$\begin{aligned} 1 &= (a_0 + a_1x + a_2x^2 + a_3x^3 + \cdots) \left( 2 + x + \frac{x^2}{2} + \frac{x^3}{6} + \cdots \right) \\ &= 2a_0 + (a_0 + 2a_1)x + \left( \frac{a_0}{2} + a_1 + 2a_2 \right) x^2 \\ &\quad + \left( \frac{a_0}{6} + \frac{a_1}{2} + a_2 + 2a_3 \right) x^3 + \cdots. \end{aligned}$$

From Corollary 4.5.7,

$$\begin{aligned} 2a_0 &= 1, \\ a_0 + 2a_1 &= 0, \\ \frac{a_0}{2} + a_1 + 2a_2 &= 0, \\ \frac{a_0}{6} + \frac{a_1}{2} + a_2 + 2a_3 &= 0. \end{aligned}$$

Solving these equations successively yields

$$\begin{aligned} a_0 &= \frac{1}{2}, \\ a_1 &= -\frac{a_0}{2} = -\frac{1}{4}, \\ a_2 &= -\frac{1}{2} \left( \frac{a_0}{2} + a_1 \right) = -\frac{1}{2} \left( \frac{1}{4} - \frac{1}{4} \right) = 0, \\ a_3 &= -\frac{1}{2} \left( \frac{a_0}{6} + \frac{a_1}{2} + a_2 \right) = -\frac{1}{2} \left( \frac{1}{12} - \frac{1}{8} + 0 \right) = \frac{1}{48}, \end{aligned}$$

so

$$\frac{1}{1 + e^x} = \frac{1}{2} - \frac{x}{4} + \frac{x^3}{48} + \cdots.$$



**Example 4.5.15** To find the reciprocal of

$$g(x) = e^x = \sum_{n=0}^{\infty} \frac{x^n}{n!}, \quad (4.5.27)$$

we again let  $h = 1$  in (4.5.25). If

$$(e^x)^{-1} = \sum_{n=0}^{\infty} a_n x^n,$$

then

$$1 = \left( \sum_{n=0}^{\infty} a_n x^n \right) \left( \sum_{n=0}^{\infty} \frac{x^n}{n!} \right) = \sum_{n=0}^{\infty} c_n x^n,$$

where

$$c_n = \sum_{r=0}^n \frac{a_r}{(n-r)!}.$$

From Corollary 4.5.7,  $c_0 = a_0 = 1$  and  $c_n = 0$  if  $n \geq 1$ ; hence,

$$a_n = - \sum_{r=0}^{n-1} \frac{a_r}{(n-r)!}, \quad n \geq 1. \quad (4.5.28)$$

Solving these equations successively for  $a_0, a_1, \dots$  yields

$$\begin{aligned} a_1 &= -\frac{1}{1!}(4.5.1) = -1, \\ a_2 &= -\left[ \frac{1}{2!}(1) + \frac{1}{1!}(-1) \right] = \frac{1}{2}, \\ a_3 &= -\left[ \frac{1}{3!}(1) + \frac{1}{2!}(-1) + \frac{1}{1!}\left(\frac{1}{2}\right) \right] = -\frac{1}{6}, \\ a_4 &= -\left[ \frac{1}{4!}(1) + \frac{1}{3!}(-1) + \frac{1}{2!}\left(\frac{1}{2}\right) + \frac{1}{1!}\left(-\frac{1}{6}\right) \right] = \frac{1}{24}. \end{aligned}$$

From this, we see that

$$a_k = \frac{(-1)^k}{k!}$$

for  $0 \leq k \leq 4$  and are led to conjecture that this holds for all  $k$ . To prove this by induction, we assume that it is so for  $0 \leq k \leq n-1$  and compute from (4.5.28):

$$\begin{aligned} a_n &= - \sum_{r=0}^{n-1} \frac{1}{(n-r)!} \frac{(-1)^r}{r!} \\ &= -\frac{1}{n!} \sum_{r=0}^{n-1} (-1)^r \binom{n}{r} \quad (\text{Exercise 1.2.19(a)}) \\ &= \frac{(-1)^n}{n!} \quad (\text{Exercise 1.2.19(b)}). \end{aligned}$$

Thus, we have shown that

$$(e^x)^{-1} = \sum_{n=0}^{\infty} (-1)^n \frac{x^n}{n!}.$$

Since this is precisely the series that results if  $x$  is replaced by  $-x$  in (4.5.27), we have verified a fundamental property of the exponential function: that

$$(e^x)^{-1} = e^{-x}.$$

This also follows from Example 4.3.26.

### Abel's Theorem

From Theorem 4.5.4, we know that a function  $f$  defined by a convergent power series

$$f(x) = \sum_{n=0}^{\infty} a_n (x - x_0)^n, \quad |x - x_0| < R, \quad (4.5.29)$$

is continuous in the open interval  $(x_0 - R, x_0 + R)$ . The next theorem concerns the behavior of  $f$  as  $x$  approaches an endpoint of the interval of convergence.

**Theorem 4.5.12 (Abel's Theorem)** *Let  $f$  be defined by a power series (4.5.29) with finite radius of convergence  $R$ .*

(a) *If  $\sum_{n=0}^{\infty} a_n R^n$  converges, then*

$$\lim_{x \rightarrow (x_0 + R)^-} f(x) = \sum_{n=0}^{\infty} a_n R^n.$$

(b) *If  $\sum_{n=0}^{\infty} (-1)^n a_n R^n$  converges, then*

$$\lim_{x \rightarrow (x_0 - R)^+} f(x) = \sum_{n=0}^{\infty} (-1)^n a_n R^n.$$

**Proof** We consider a simpler problem first. Let

$$g(y) = \sum_{n=0}^{\infty} b_n y^n$$

and

$$\sum_{n=0}^{\infty} b_n = s \quad (\text{finite}).$$

We will show that

$$\lim_{y \rightarrow 1^-} g(y) = s. \quad (4.5.30)$$

From Example 4.5.11,

$$g(y) = (1 - y) \sum_{n=0}^{\infty} s_n y^n, \quad (4.5.31)$$

where

$$s_n = b_0 + b_1 + \cdots + b_n.$$

Since

$$\frac{1}{1-y} = \sum_{n=0}^{\infty} y^n \quad \text{and therefore} \quad 1 = (1-y) \sum_{n=0}^{\infty} y^n, \quad |y| < 1, \quad (4.5.32)$$

we can multiply through by  $s$  and write

$$s = (1-y) \sum_{n=0}^{\infty} s y^n, \quad |y| < 1.$$

Subtracting this from (4.5.31) yields

$$g(y) - s = (1-y) \sum_{n=0}^{\infty} (s_n - s) y^n, \quad |y| < 1.$$

If  $\epsilon > 0$ , choose  $N$  so that

$$|s_n - s| < \epsilon \quad \text{if} \quad n \geq N + 1.$$

Then, if  $0 < y < 1$ ,

$$\begin{aligned} |g(y) - s| &\leq (1-y) \sum_{n=0}^N |s_n - s| y^n + (1-y) \sum_{n=N+1}^{\infty} |s_n - s| y^n \\ &< (1-y) \sum_{n=0}^N |s_n - s| y^n + (1-y) \epsilon y^{N+1} \sum_{n=0}^{\infty} y^n \\ &< (1-y) \sum_{n=0}^N |s_n - s| + \epsilon, \end{aligned}$$

because of the second equality in (4.5.32). Therefore,

$$|g(y) - s| < 2\epsilon$$

if

$$(1-y) \sum_{n=0}^N |s_n - s| < \epsilon.$$

This proves (4.5.30).

To obtain (a) from this, let  $b_n = a_n R^n$  and  $g(y) = f(x_0 + Ry)$ ; to obtain (b), let  $b_n = (-1)^n a_n R^n$  and  $g(y) = f(x_0 - Ry)$ . ■

**Example 4.5.16** The series

$$f(x) = \frac{1}{1+x} = \sum_{n=0}^{\infty} (-1)^n x^n$$

diverges at  $x = 1$ , while  $\lim_{x \rightarrow 1^-} f(x) = 1/2$ . This shows that the converse of Abel's theorem is false. Integrating the series term by term yields

$$\log(1+x) = \sum_{n=0}^{\infty} (-1)^n \frac{x^{n+1}}{n+1}, \quad |x| < 1,$$

where the power series converges at  $x = 1$ , and Abel's theorem implies that

$$\log 2 = \sum_{n=0}^{\infty} \frac{(-1)^{n+1}}{n+1}.$$

**Example 4.5.17** If  $q \geq 0$ , the binomial series

$$\sum_{n=0}^{\infty} \binom{q}{n} x^n$$

converges absolutely for  $x = \pm 1$ . This is obvious if  $q$  is a nonnegative integer, and it follows from Raabe's test for other positive values of  $q$ , since

$$\left| \frac{a_{n+1}}{a_n} \right| = \left| \binom{q}{n+1} / \binom{q}{n} \right| = \frac{n-q}{n+1}, \quad n > q,$$

and

$$\begin{aligned} \lim_{n \rightarrow \infty} n \left( \left| \frac{a_{n+1}}{a_n} \right| - 1 \right) &= \lim_{n \rightarrow \infty} n \left( \frac{n-q}{n+1} - 1 \right) \\ &= \lim_{n \rightarrow \infty} \frac{n}{n+1} (-q-1) = -q-1. \end{aligned}$$

Therefore, Abel's theorem and (4.5.21) imply that

$$\sum_{n=0}^{\infty} \binom{q}{n} = 2^q \quad \text{and} \quad \sum_{n=0}^{\infty} (-1)^n \binom{q}{n} = 0, \quad q \geq 0.$$

## 4.5 Exercises

- 
1. The possibilities listed in Theorem 4.5.2(c) for behavior of a power series at the endpoints of its interval of convergence do not include absolute convergence at one endpoint and conditional convergence or divergence at the other. Why can't these occur?

2. Find the radius of convergence.

$$(a) \sum \left( \frac{n+1}{n} \right)^{n^2} [2 + (-1)^n]^n x^n \quad (b) \sum 2^{\sqrt{n}} (x-1)^n$$

$$(c) \sum \left( 2 + \sin \frac{n\pi}{6} \right)^n (x+2)^n \quad (d) \sum n^{\sqrt{n}} x^n$$

$$(e) \sum \left( \frac{x}{n} \right)^n$$

3. (a) Prove: If  $\{a_n r^n\}$  is bounded and  $|x_1 - x_0| < r$ , then  $\sum a_n (x_1 - x_0)^n$  converges.  
 (b) Prove: If  $\sum a_n (x - x_0)^n$  has radius of convergence  $R$  and  $|x_1 - x_0| > R$ , then  $\{a_n (x_1 - x_0)^n\}$  is unbounded.
4. Prove: If  $g$  is a rational function defined for all nonnegative integers, then  $\sum a_n x^n$  and  $\sum a_n g(n) x^n$  have the same radius of convergence. HINT: Use Exercise 4.1.30(a).
5. Suppose that  $f(x) = \sum a_n (x - x_0)^n$  has radius of convergence  $R$  and  $0 < r < R_1 < R$ . Show that there is an integer  $k$  such that

$$\left| f(x) - \sum_{n=0}^k a_n (x - x_0)^n \right| \leq \left( \frac{r}{R_1} \right)^{k+1} \frac{R_1}{R_1 - r}$$

if  $|x - x_0| \leq r$  and  $k \geq k$ .

6. Suppose that  $k$  is a positive integer and

$$f(x) = \sum_{n=0}^{\infty} a_n x^n$$

has radius of convergence  $R$ . Show that the series

$$g(x) = f(x^k) = \sum_{n=0}^{\infty} a_n x^{kn}$$

has radius of convergence  $R^{1/k}$ .

7. Complete the proof of Theorem 4.5.3 by showing that

$$(a) R = 0 \text{ if } \lim_{n \rightarrow \infty} |a_{n+1}|/|a_n| = \infty;$$

$$(b) R = \infty \text{ if } \lim_{n \rightarrow \infty} |a_{n+1}|/|a_n| = 0.$$

8. Find the radius of convergence.

$$(a) \sum (\log n) x^n$$

$$(b) \sum 2^n n^p (x+1)^n$$

$$(c) \sum (-1)^n \binom{2n}{n} x^n$$

$$(d) \sum (-1)^n \frac{n^2 + 1}{n 4^n} (x-1)^n$$

$$(e) \sum \frac{n^n}{n!} (x+2)^n$$

$$(f) \sum \frac{\alpha(\alpha+1)\cdots(\alpha+n-1)}{\beta(\beta+1)\cdots(\beta+n-1)} x^n$$

$(\alpha, \beta \neq \text{negative integer})$

9. Suppose that  $a_n \neq 0$  for  $n$  sufficiently large. Show that

$$(a) \quad \lim_{n \rightarrow \infty} \left| \frac{a_{n+1}}{a_n} \right| \leq \lim_{n \rightarrow \infty} |a_n|^{1/n} \quad \text{and} \quad (b) \quad \overline{\lim}_{n \rightarrow \infty} |a_n|^{1/n} \leq \overline{\lim}_{n \rightarrow \infty} \left| \frac{a_{n+1}}{a_n} \right|.$$

Show that this implies Theorem 4.5.3.

10. Given that

$$\frac{1}{1-x} = \sum_{n=0}^{\infty} x^n, \quad |x| < 1,$$

use Theorem 4.5.4 to express  $\sum_{n=0}^{\infty} n^2 x^n$  in closed form.

11. The function

$$J_p(x) = \sum_{n=0}^{\infty} \frac{(-1)^n}{n!(n+p)!} \left(\frac{x}{2}\right)^{2n+p} \quad (p = \text{integer} \geq 0)$$

is the *Bessel function of order  $p$* . Show that

- (a)  $J'_0 = -J_1$ .  
 (b)  $J'_p = \frac{1}{2}(J_{p-1} - J_{p+1})$ ,  $p \geq 1$ .  
 (c)  $x^2 J''_p + x J'_p + (x^2 - p^2) J_p = 0$ .

12. Given that the power series  $f(x) = \sum_{n=0}^{\infty} a_n x^n$  satisfies

$$f'(x) = -2xf(x), \quad f(0) = 1,$$

find  $\{a_n\}$ . Do you recognize  $f$ ?

13. Let

$$f(x) = \sum_{n=0}^{\infty} a_n x^n, \quad |x| < R,$$

and  $g(x) = f(x^k)$ , where  $k$  is a positive integer. Show that

$$g^{(r)}(0) = 0 \quad \text{if } r \neq kn \quad \text{and} \quad g^{(kn)}(0) = \frac{(kn)!}{n!} f^{(n)}(0), \quad n \geq 0.$$

14. Let

$$f(x) = \sum_{n=0}^{\infty} a_n (x - x_0)^n, \quad |x - x_0| < R,$$

and  $f(t_n) = 0$ , where  $t_n \neq x_0$  and  $\lim_{n \rightarrow \infty} t_n = x_0$ . Show that  $f(x) \equiv 0$  ( $|x - x_0| < R$ ). HINT: *Rolle's theorem helps here.*

15. Prove Theorem 4.5.8.

16. Express

$$\int_1^x \frac{\log t}{t-1} dt$$

as a power series in  $x - 1$  and find the radius of convergence of the series.

17. By substituting  $-x^2$  for  $x$  in the geometric series, we obtain

$$\frac{1}{1+x^2} = \sum_{n=0}^{\infty} (-1)^n x^{2n}, \quad |x| < 1.$$

Use this to express  $f(x) = \tan^{-1} x$  ( $f(0) = 0$ ) as a power series in  $x$ . Then evaluate all derivatives of  $f$  at  $x_0 = 0$ , and find a series of constants that converges to  $\pi/6$ .

18. Prove: If

$$f(x) = \sum_{n=0}^{\infty} a_n (x - x_0)^n, \quad |x - x_0| < R,$$

and  $F$  is an antiderivative of  $f$  on  $(x_0 - R, x_0 + R)$ , then

$$F(x) = C + \sum_{n=0}^{\infty} \frac{a_n}{n+1} (x - x_0)^{n+1}, \quad |x - x_0| < R,$$

where  $C$  is a constant.

19. Suppose that some derivative of  $f$  can be represented by a power series in  $x - x_0$  in an interval about  $x_0$ . Show that  $f$  and all its derivatives can also.
20. Verify Eqn. (4.5.21) by showing that

$$(1+x)^{-q} \sum_{n=0}^{\infty} \binom{q}{n} x^n = 1, \quad |x| < 1,$$

HINT: *Differentiate.*

21. Prove Theorem 4.5.10.
22. Find the Maclaurin series of  $\cosh x$  and  $\sinh x$  from the definition in Eqn. (4.5.16), and also by applying Theorem 4.5.10 to the Maclaurin series for  $e^x$  and  $e^{-x}$ .
23. Give an example where the radius of convergence of the product of two power series is greater than the smaller of the radii of convergence of the factors.
24. Use Theorem 4.5.11 to find the first four nonzero terms in the Maclaurin.
- (a)  $e^x \sin x$    (b)  $\frac{e^{-x}}{1+x^2}$    (c)  $\frac{\cos x}{1+x^6}$    (d)  $(\sin x) \log(1+x)$

25. Derive the identity

$$2 \sin x \cos x = \sin 2x$$

from the Maclaurin series for  $\sin x$ ,  $\cos x$ , and  $\sin 2x$ .

26. (a) Given that

$$(1 - 2xt + x^2)^{-1/2} = \sum_{n=0}^{\infty} P_n(t)x^n, \quad |x| < 1, \quad (\text{A})$$

if  $-1 < t < 1$ , show that  $P_0(t) = 1$ ,  $P_1(t) = t$ , and

$$P_{n+1}(t) = \frac{2n+1}{n+1}tP_n(t) - \frac{n}{n+1}P_{n-1}(t), \quad n \geq 1.$$

HINT: First differentiate (A) with respect to  $x$ .

- (b) Show from (a) that  $P_n$  is a polynomial of degree  $n$ . It is the  $n$ th Legendre polynomial, and  $(1-2xt+x^2)^{-1/2}$  is the generating function of the sequence  $\{P_n\}$ .
27. Define (if necessary) the given function so as to be continuous at  $x_0 = 0$ , and find the first four nonzero terms of its Maclaurin series.
- (a)  $\frac{xe^x}{\sin x}$                       (b)  $\frac{\cos x}{1+x+x^2}$                       (c)  $\sec x$
- (d)  $x \csc x$                       (e)  $\frac{\sin 2x}{\sin x}$
28. Let  $a_0 = a_1 = 5$  and  $a_{n+1} = a_n - 6a_{n-1}$ ,  $n \geq 1$ .
- (a) Express  $F(x) = \sum_{n=0}^{\infty} a_n x^n$  in closed form.
- (b) Write  $F$  as the difference of two geometric series, and find an explicit formula for  $a_n$ .
29. Starting from the Maclaurin series

$$\log(1-x) = -\sum_{n=0}^{\infty} \frac{x^{n+1}}{n+1}, \quad |x| < 1,$$

use Abel's theorem to evaluate

$$\sum_{n=0}^{\infty} \frac{1}{(n+1)(n+2)}.$$

30. In Example 4.5.17 we saw that

$$\sum_{n=0}^{\infty} \binom{q}{n} = 2^q, \quad q \geq 0.$$

Show that this also holds for  $-1 < q < 0$ , but not for  $q \leq -1$ . HINT: See Exercise 4.1.35.

31. (a) Prove: If  $\sum_{n=0}^{\infty} b_n$  converges, then the series  $g(x) = \sum_{n=0}^{\infty} b_n x^n$  converges uniformly on  $[0, 1]$ . HINT: If  $\epsilon > 0$ , there is an integer  $N$  such that

$$|b_n + b_{n+1} + \cdots + b_m| < \epsilon \quad \text{if } n, m \geq N.$$

Use summation by parts to show that then

$$|b_n x^n + b_{n-1} x^{n-1} + \cdots + b_m x^m| < 2\epsilon \quad \text{if } 0 \leq x < 1, \quad n, m \geq N.$$

This is also known as Abel's theorem.



(b) Show that (a) implies the restricted form of Theorem 4.5.12 (concerning  $g$ ) proved in the text.

32. Use Exercise 4.5.31 to show that if  $\sum_{n=0}^{\infty} a_n$ ,  $\sum_{n=0}^{\infty} b_n$ , and their Cauchy product  $\sum_{n=0}^{\infty} c_n$  all converge, then

$$\left(\sum_{n=0}^{\infty} a_n\right)\left(\sum_{n=0}^{\infty} b_n\right) = \sum_{n=0}^{\infty} c_n.$$

33. Prove: If

$$g(x) = \sum_{n=0}^{\infty} b_n x^n, \quad |x| < 1,$$

and  $b_n \geq 0$ , then

$$\sum_{n=0}^{\infty} b_n = \lim_{x \rightarrow 1^-} g(x) \quad (\text{finite or infinite}).$$

34. Use the binomial series and the relation

$$\frac{d}{dx}(\sin^{-1} x) = (1 - x^2)^{-1/2}$$

to obtain the Maclaurin series for  $\sin^{-1} x$  ( $\sin^{-1} 0 = 0$ ). Deduce from this series and Exercise 4.5.33 that

$$\sum_{n=0}^{\infty} \binom{2n}{n} \frac{1}{2^{2n}(2n+1)} = \frac{\pi}{2}.$$

## CHAPTER 5

### Real-Valued Functions of Several Variables

IN THIS CHAPTER we consider real-valued function of  $n$  variables, where  $n > 1$ .

SECTION 5.1 deals with the structure of  $\mathbb{R}^n$ , the space of ordered  $n$ -tuples of real numbers, which we call *vectors*. We define the sum of two vectors, the product of a vector and a real number, the length of a vector, and the inner product of two vectors. We study the arithmetic properties of  $\mathbb{R}^n$ , including Schwarz's inequality and the triangle inequality. We define neighborhoods and open sets in  $\mathbb{R}^n$ , define convergence of a sequence of points in  $\mathbb{R}^n$ , and extend the Heine–Borel theorem to  $\mathbb{R}^n$ . The section concludes with a discussion of connected subsets of  $\mathbb{R}^n$ .

SECTION 5.2 deals with boundedness, limits, continuity, and uniform continuity of a function of  $n$  variables; that is, a function defined on a subset of  $\mathbb{R}^n$ .

SECTION 5.3 defines directional and partial derivatives of a real-valued function of  $n$  variables. This is followed by the definition of differentiability of such functions. We define the differential of such a function and give a geometric interpretation of differentiability.

SECTION 5.4 deals with the chain rule and Taylor's theorem for a real-valued function of  $n$  variables.

#### 5.1 STRUCTURE OF $\mathbb{R}^n$

In this chapter we study functions defined on subsets of the real  $n$ -dimensional space  $\mathbb{R}^n$ , which consists of all ordered  $n$ -tuples  $\mathbf{X} = (x_1, x_2, \dots, x_n)$  of real numbers, called the *coordinates* or *components* of  $\mathbf{X}$ . This space is sometimes called *Euclidean  $n$ -space*.

In this section we introduce an algebraic structure for  $\mathbb{R}^n$ . We also consider its *topological* properties; that is, properties that can be described in terms of a special class of subsets, the neighborhoods in  $\mathbb{R}^n$ . In Section 1.3 we studied the topological properties of  $\mathbb{R}^1$ , which we will continue to denote simply as  $\mathbb{R}$ . Most of the definitions and proofs in Section 1.3 were stated in terms of neighborhoods in  $\mathbb{R}$ . We will see that they carry over to  $\mathbb{R}^n$  if the concept of neighborhood in  $\mathbb{R}^n$  is suitably defined.

Members of  $\mathbb{R}$  have dual interpretations: geometric, as points on the real line, and algebraic, as real numbers. We assume that you are familiar with the geometric interpretation of members of  $\mathbb{R}^2$  and  $\mathbb{R}^3$  as the rectangular coordinates of points in a plane and three-dimensional space, respectively. Although  $\mathbb{R}^n$  cannot be visualized geometrically if  $n \geq 4$ , geometric ideas from  $\mathbb{R}$ ,  $\mathbb{R}^2$ , and  $\mathbb{R}^3$  often help us to interpret the properties of  $\mathbb{R}^n$  for arbitrary  $n$ .

As we said in Section 1.3, the idea of neighborhood is always associated with some definition of “closeness” of points. The following definition imposes an algebraic structure on  $\mathbb{R}^n$ , in terms of which the distance between two points can be defined in a natural way. In addition, this algebraic structure will be useful later for other purposes.

**Definition 5.1.1** The *vector sum* of

$$\mathbf{X} = (x_1, x_2, \dots, x_n) \quad \text{and} \quad \mathbf{Y} = (y_1, y_2, \dots, y_n)$$

is

$$\mathbf{X} + \mathbf{Y} = (x_1 + y_1, x_2 + y_2, \dots, x_n + y_n). \quad (5.1.1)$$

If  $a$  is a real number, the *scalar multiple of  $\mathbf{X}$  by  $a$*  is

$$a\mathbf{X} = (ax_1, ax_2, \dots, ax_n). \quad (5.1.2)$$

■

Note that “+” has two distinct meanings in (5.1.1): on the left, “+” stands for the newly defined addition of members of  $\mathbb{R}^n$  and, on the right, for addition of real numbers. However, this can never lead to confusion, since the meaning of “+” can always be deduced from the symbols on either side of it. A similar comment applies to the use of juxtaposition to indicate scalar multiplication on the left of (5.1.2) and multiplication of real numbers on the right.

**Example 5.1.1** In  $\mathbb{R}^4$ , let

$$\mathbf{X} = (1, -2, 6, 5) \quad \text{and} \quad \mathbf{Y} = (3, -5, 4, \frac{1}{2}).$$

Then

$$\mathbf{X} + \mathbf{Y} = (4, -7, 10, \frac{11}{2})$$

and

$$6\mathbf{X} = (6, -12, 36, 30).$$

■

We leave the proof of the following theorem to you (Exercise 5.1.2).

**Theorem 5.1.2** If  $\mathbf{X}$ ,  $\mathbf{Y}$ , and  $\mathbf{Z}$  are in  $\mathbb{R}^n$  and  $a$  and  $b$  are real numbers, then

- (a)  $\mathbf{X} + \mathbf{Y} = \mathbf{Y} + \mathbf{X}$  (vector addition is commutative).
- (b)  $(\mathbf{X} + \mathbf{Y}) + \mathbf{Z} = \mathbf{X} + (\mathbf{Y} + \mathbf{Z})$  (vector addition is associative).
- (c) There is a unique vector  $\mathbf{0}$ , called the zero vector, such that  $\mathbf{X} + \mathbf{0} = \mathbf{X}$  for all  $\mathbf{X}$  in  $\mathbb{R}^n$ .
- (d) For each  $\mathbf{X}$  in  $\mathbb{R}^n$  there is a unique vector  $-\mathbf{X}$  such that  $\mathbf{X} + (-\mathbf{X}) = \mathbf{0}$ .
- (e)  $a(b\mathbf{X}) = (ab)\mathbf{X}$ .
- (f)  $(a + b)\mathbf{X} = a\mathbf{X} + b\mathbf{X}$ .
- (g)  $a(\mathbf{X} + \mathbf{Y}) = a\mathbf{X} + a\mathbf{Y}$ .
- (h)  $1\mathbf{X} = \mathbf{X}$ .

Clearly,  $\mathbf{0} = (0, 0, \dots, 0)$  and, if  $\mathbf{X} = (x_1, x_2, \dots, x_n)$ , then

$$-\mathbf{X} = (-x_1, -x_2, \dots, -x_n).$$

We write  $\mathbf{X} + (-\mathbf{Y})$  as  $\mathbf{X} - \mathbf{Y}$ . The point  $\mathbf{0}$  is called the *origin*.

A nonempty set  $V = \{\mathbf{X}, \mathbf{Y}, \mathbf{Z}, \dots\}$ , together with rules such as (5.1.1), associating a unique member of  $V$  with every ordered pair of its members, and (5.1.2), associating a unique member of  $V$  with every real number and member of  $V$ , is said to be a *vector space* if it has the properties listed in Theorem 5.1.2. The members of a vector space are called *vectors*. When we wish to emphasize that we are regarding a member of  $\mathbb{R}^n$  as part of this algebraic structure, we will speak of it as a vector; otherwise, we will speak of it as a point.

## Length, Distance, and Inner Product

**Definition 5.1.3** The *length* of the vector  $\mathbf{X} = (x_1, x_2, \dots, x_n)$  is

$$|\mathbf{X}| = (x_1^2 + x_2^2 + \dots + x_n^2)^{1/2}.$$

The *distance between points  $\mathbf{X}$  and  $\mathbf{Y}$*  is  $|\mathbf{X} - \mathbf{Y}|$ ; in particular,  $|\mathbf{X}|$  is the distance between  $\mathbf{X}$  and the origin. If  $|\mathbf{X}| = 1$ , then  $\mathbf{X}$  is a *unit vector*. ■

If  $n = 1$ , this definition of length reduces to the familiar absolute value, and the distance between two points is the length of the interval having them as endpoints; for  $n = 2$  and  $n = 3$ , the length and distance of Definition 5.1.3 reduce to the familiar definitions for the plane and three-dimensional space.

**Example 5.1.2** The lengths of the vectors

$$\mathbf{X} = (1, -2, 6, 5) \quad \text{and} \quad \mathbf{Y} = (3, -5, 4, \frac{1}{2})$$

are

$$|\mathbf{X}| = (1^2 + (-2)^2 + 6^2 + 5^2)^{1/2} = \sqrt{66}$$

and

$$|\mathbf{Y}| = (3^2 + (-5)^2 + 4^2 + (\frac{1}{2})^2)^{1/2} = \frac{\sqrt{201}}{2}.$$

The distance between  $\mathbf{X}$  and  $\mathbf{Y}$  is

$$|\mathbf{X} - \mathbf{Y}| = ((1 - 3)^2 + (-2 + 5)^2 + (6 - 4)^2 + (5 - \frac{1}{2})^2)^{1/2} = \frac{\sqrt{149}}{2}.$$

**Definition 5.1.4** The *inner product*  $\mathbf{X} \cdot \mathbf{Y}$  of  $\mathbf{X} = (x_1, x_2, \dots, x_n)$  and  $\mathbf{Y} = (y_1, y_2, \dots, y_n)$  is

$$\mathbf{X} \cdot \mathbf{Y} = x_1 y_1 + x_2 y_2 + \dots + x_n y_n.$$

**Lemma 5.1.5 (Schwarz's Inequality)** If  $\mathbf{X}$  and  $\mathbf{Y}$  are any two vectors in  $\mathbb{R}^n$ , then

$$|\mathbf{X} \cdot \mathbf{Y}| \leq |\mathbf{X}| |\mathbf{Y}|, \quad (5.1.3)$$

with equality if and only if one of the vectors is a scalar multiple of the other.

**Proof** If  $\mathbf{Y} = \mathbf{0}$ , then both sides of (5.1.3) are  $\mathbf{0}$ , so (5.1.3) holds, with equality. In this case,  $\mathbf{Y} = 0\mathbf{X}$ . Now suppose that  $\mathbf{Y} \neq \mathbf{0}$  and  $t$  is any real number. Then

$$\begin{aligned} 0 &\leq \sum_{i=1}^n (x_i - ty_i)^2 \\ &= \sum_{i=1}^n x_i^2 - 2t \sum_{i=1}^n x_i y_i + t^2 \sum_{i=1}^n y_i^2 \\ &= |\mathbf{X}|^2 - 2(\mathbf{X} \cdot \mathbf{Y})t + t^2 |\mathbf{Y}|^2. \end{aligned} \quad (5.1.4)$$

The last expression is a second-degree polynomial  $p$  in  $t$ . From the quadratic formula, the zeros of  $p$  are

$$t = \frac{(\mathbf{X} \cdot \mathbf{Y}) \pm \sqrt{(\mathbf{X} \cdot \mathbf{Y})^2 - |\mathbf{X}|^2 |\mathbf{Y}|^2}}{|\mathbf{Y}|^2}.$$

Hence,

$$(\mathbf{X} \cdot \mathbf{Y})^2 \leq |\mathbf{X}|^2 |\mathbf{Y}|^2, \quad (5.1.5)$$

because if not, then  $p$  would have two distinct real zeros and therefore be negative between them (Figure 5.1.1), contradicting the inequality (5.1.4). Taking square roots in (5.1.5) yields (5.1.3) if  $\mathbf{Y} \neq \mathbf{0}$ .

If  $\mathbf{X} = t\mathbf{Y}$ , then  $|\mathbf{X} \cdot \mathbf{Y}| = |\mathbf{X}| |\mathbf{Y}| = |t| |\mathbf{Y}|^2$  (verify), so equality holds in (5.1.3). Conversely, if equality holds in (5.1.3), then  $p$  has the real zero  $t_0 = (\mathbf{X} \cdot \mathbf{Y}) / |\mathbf{Y}|^2$ , and

$$\sum_{i=1}^n (x_i - t_0 y_i)^2 = 0$$

from (5.1.4); therefore,  $\mathbf{X} = t_0 \mathbf{Y}$ . ■

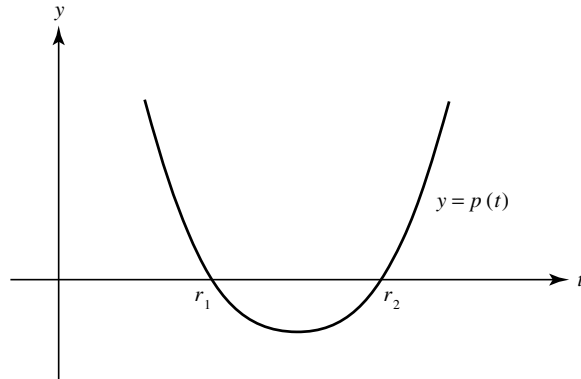


Figure 5.1.1

**Theorem 5.1.6 (Triangle Inequality)** *If  $\mathbf{X}$  and  $\mathbf{Y}$  are in  $\mathbb{R}^n$ , then*

$$|\mathbf{X} + \mathbf{Y}| \leq |\mathbf{X}| + |\mathbf{Y}|, \quad (5.1.6)$$

*with equality if and only if one of the vectors is a nonnegative multiple of the other.*

**Proof** By definition,

$$\begin{aligned} |\mathbf{X} + \mathbf{Y}|^2 &= \sum_{i=1}^n (x_i + y_i)^2 = \sum_{i=1}^n x_i^2 + 2 \sum_{i=1}^n x_i y_i + \sum_{i=1}^n y_i^2 \\ &= |\mathbf{X}|^2 + 2(\mathbf{X} \cdot \mathbf{Y}) + |\mathbf{Y}|^2 \\ &\leq |\mathbf{X}|^2 + 2|\mathbf{X}||\mathbf{Y}| + |\mathbf{Y}|^2 \quad (\text{by Schwarz's inequality}) \\ &= (|\mathbf{X}| + |\mathbf{Y}|)^2. \end{aligned} \quad (5.1.7)$$

Hence,

$$|\mathbf{X} + \mathbf{Y}|^2 \leq (|\mathbf{X}| + |\mathbf{Y}|)^2.$$

Taking square roots yields (5.1.6).

From the third line of (5.1.7), equality holds in (5.1.6) if and only if  $\mathbf{X} \cdot \mathbf{Y} = |\mathbf{X}||\mathbf{Y}|$ , which is true if and only if one of the vectors  $\mathbf{X}$  and  $\mathbf{Y}$  is a nonnegative scalar multiple of the other (Lemma 5.1.5). ■

**Corollary 5.1.7** *If  $\mathbf{X}$ ,  $\mathbf{Y}$ , and  $\mathbf{Z}$  are in  $\mathbb{R}^n$ , then*

$$|\mathbf{X} - \mathbf{Z}| \leq |\mathbf{X} - \mathbf{Y}| + |\mathbf{Y} - \mathbf{Z}|.$$

**Proof** Write

$$\mathbf{X} - \mathbf{Z} = (\mathbf{X} - \mathbf{Y}) + (\mathbf{Y} - \mathbf{Z}),$$

and apply Theorem 5.1.6 with  $\mathbf{X}$  and  $\mathbf{Y}$  replaced by  $\mathbf{X} - \mathbf{Y}$  and  $\mathbf{Y} - \mathbf{Z}$ . ■

**Corollary 5.1.8** *If  $\mathbf{X}$  and  $\mathbf{Y}$  are in  $\mathbb{R}^n$ , then*

$$|\mathbf{X} - \mathbf{Y}| \geq ||\mathbf{X}| - |\mathbf{Y}||.$$

**Proof** Since

$$\mathbf{X} = \mathbf{Y} + (\mathbf{X} - \mathbf{Y}),$$

Theorem 5.1.6 implies that

$$|\mathbf{X}| \leq |\mathbf{Y}| + |\mathbf{X} - \mathbf{Y}|,$$

which is equivalent to

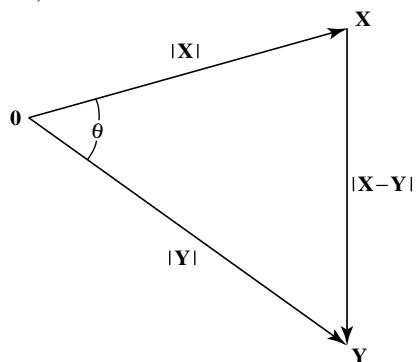
$$|\mathbf{X}| - |\mathbf{Y}| \leq |\mathbf{X} - \mathbf{Y}|.$$

Interchanging  $\mathbf{X}$  and  $\mathbf{Y}$  yields

$$|\mathbf{Y}| - |\mathbf{X}| \leq |\mathbf{Y} - \mathbf{X}|.$$

Since  $|\mathbf{X} - \mathbf{Y}| = |\mathbf{Y} - \mathbf{X}|$ , the last two inequalities imply the stated conclusion. ■

**Example 5.1.3** *The angle between two nonzero vectors  $\mathbf{X} = (x_1, x_2, x_3)$  and  $\mathbf{Y} = (y_1, y_2, y_3)$  in  $\mathbb{R}^3$  is the angle between the directed line segments from the origin to the points  $\mathbf{X}$  and  $\mathbf{Y}$  (Figure 5.1.2).*



**Figure 5.1.2**

Applying the law of cosines to the triangle in Figure 5.1.2 yields

$$|\mathbf{X} - \mathbf{Y}|^2 = |\mathbf{X}|^2 + |\mathbf{Y}|^2 - 2|\mathbf{X}||\mathbf{Y}| \cos \theta. \quad (5.1.8)$$

However,

$$\begin{aligned} |\mathbf{X} - \mathbf{Y}|^2 &= (x_1 - y_1)^2 + (x_2 - y_2)^2 + (x_3 - y_3)^2 \\ &= (x_1^2 + x_2^2 + x_3^2) + (y_1^2 + y_2^2 + y_3^2) - 2(x_1y_1 + x_2y_2 + x_3y_3) \\ &= |\mathbf{X}|^2 + |\mathbf{Y}|^2 - 2\mathbf{X} \cdot \mathbf{Y}. \end{aligned}$$

Comparing this with (5.1.8) yields

$$\mathbf{X} \cdot \mathbf{Y} = |\mathbf{X}| |\mathbf{Y}| \cos \theta.$$

Since  $|\cos \theta| \leq 1$ , this verifies Schwarz's inequality in  $\mathbb{R}^3$ .

**Example 5.1.4** Connecting the points  $\mathbf{0}$ ,  $\mathbf{X}$ ,  $\mathbf{Y}$ , and  $\mathbf{X} + \mathbf{Y}$  in  $\mathbb{R}^2$  or  $\mathbb{R}^3$  (Figure 5.1.3) produces a parallelogram with sides of length  $|\mathbf{X}|$  and  $|\mathbf{Y}|$  and a diagonal of length  $|\mathbf{X} + \mathbf{Y}|$ .

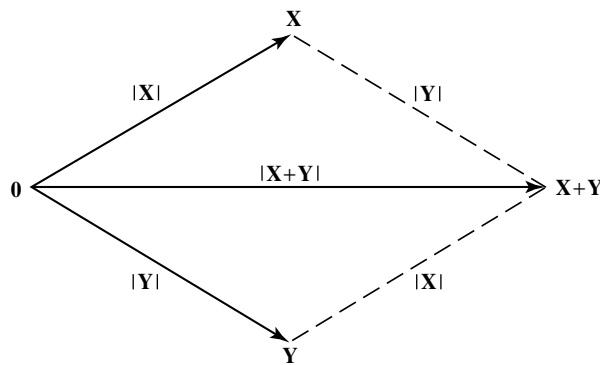


Figure 5.1.3

Thus, there is a triangle with sides  $|\mathbf{X}|$ ,  $|\mathbf{Y}|$ , and  $|\mathbf{X} + \mathbf{Y}|$ . From this, we see geometrically that

$$|\mathbf{X} + \mathbf{Y}| \leq |\mathbf{X}| + |\mathbf{Y}|$$

in  $\mathbb{R}^2$  or  $\mathbb{R}^3$ , since the length of one side of a triangle cannot exceed the sum of the lengths of the other two. This verifies (5.1.6) for  $\mathbb{R}^2$  and  $\mathbb{R}^3$  and indicates why (5.1.6) is called the triangle inequality. ■

The next theorem lists properties of length, distance, and inner product that follow directly from Definitions 5.1.3 and 5.1.4. We leave the proof to you (Exercise 5.1.6).

**Theorem 5.1.9** If  $\mathbf{X}$ ,  $\mathbf{Y}$ , and  $\mathbf{Z}$  are members of  $\mathbb{R}^n$  and  $a$  is a scalar, then

- (a)  $|a\mathbf{X}| = |a| |\mathbf{X}|$ .
- (b)  $|\mathbf{X}| \geq 0$ , with equality if and only if  $\mathbf{X} = \mathbf{0}$ .
- (c)  $|\mathbf{X} - \mathbf{Y}| \geq 0$ , with equality if and only if  $\mathbf{X} = \mathbf{Y}$ .
- (d)  $\mathbf{X} \cdot \mathbf{Y} = \mathbf{Y} \cdot \mathbf{X}$ .
- (e)  $\mathbf{X} \cdot (\mathbf{Y} + \mathbf{Z}) = \mathbf{X} \cdot \mathbf{Y} + \mathbf{X} \cdot \mathbf{Z}$ .
- (f)  $(c\mathbf{X}) \cdot \mathbf{Y} = \mathbf{X} \cdot (c\mathbf{Y}) = c(\mathbf{X} \cdot \mathbf{Y})$ .



**Line Segments in  $\mathbb{R}^n$** 

The equation of a line through a point  $\mathbf{X}_0 = (x_0, y_0, z_0)$  in  $\mathbb{R}^3$  can be written parametrically as

$$x = x_0 + u_1t, \quad y = y_0 + u_2t, \quad z = z_0 + u_3t, \quad -\infty < t < \infty,$$

where  $u_1, u_2$ , and  $u_3$  are not all zero. We write this in vector form as

$$\mathbf{X} = \mathbf{X}_0 + t\mathbf{U}, \quad -\infty < t < \infty, \quad (5.1.9)$$

with  $\mathbf{U} = (u_1, u_2, u_3)$ , and we say that the line is *through  $\mathbf{X}_0$  in the direction of  $\mathbf{U}$* .

There are many ways to represent a given line parametrically. For example,

$$\mathbf{X} = \mathbf{X}_0 + s\mathbf{V}, \quad -\infty < s < \infty, \quad (5.1.10)$$

represents the same line as (5.1.9) if and only if  $\mathbf{V} = a\mathbf{U}$  for some nonzero real number  $a$ . Then the line is traversed in the same direction as  $s$  and  $t$  vary from  $-\infty$  to  $\infty$  if  $a > 0$ , or in opposite directions if  $a < 0$ .

To write the parametric equation of a line through two points  $\mathbf{X}_0$  and  $\mathbf{X}_1$  in  $\mathbb{R}^3$ , we take  $\mathbf{U} = \mathbf{X}_1 - \mathbf{X}_0$  in (5.1.9), which yields

$$\mathbf{X} = \mathbf{X}_0 + t(\mathbf{X}_1 - \mathbf{X}_0) = t\mathbf{X}_1 + (1 - t)\mathbf{X}_0, \quad -\infty < t < \infty.$$

The line segment from  $\mathbf{X}_0$  to  $\mathbf{X}_1$  consists of those points for which  $0 \leq t \leq 1$ .

**Example 5.1.5** The line  $L$  defined by

$$x = -1 + 2t, \quad y = 3 - 4t, \quad z = -1, \quad -\infty < t < \infty,$$

which can be rewritten as

$$\mathbf{X} = (-1, 3, -1) + t(2, -4, 0), \quad -\infty < t < \infty, \quad (5.1.11)$$

is through  $\mathbf{X}_0 = (-1, 3, -1)$  in the direction of  $\mathbf{U} = (2, -4, 0)$ . The same line can be represented by

$$\mathbf{X} = (-1, 3, -1) + s(1, -2, 0), \quad -\infty < s < \infty, \quad (5.1.12)$$

or by

$$\mathbf{X} = (-1, 3, -1) + \tau(-4, 8, 0), \quad -\infty < \tau < \infty. \quad (5.1.13)$$

Since

$$(1, -2, 0) = \frac{1}{2}(2, -4, 0),$$

$L$  is traversed in the same direction as  $t$  and  $s$  vary from  $-\infty$  to  $\infty$  in (5.1.11) and (5.1.12). However, since

$$(-4, 8, 0) = -2(2, -4, 0),$$

$L$  is traversed in opposite directions as  $t$  and  $\tau$  vary from  $-\infty$  to  $\infty$  in (5.1.11) and (5.1.13).

Setting  $t = 1$  in (5.1.11), we see that  $\mathbf{X}_1 = (1, -1, -1)$  is also on  $L$ . The line segment from  $\mathbf{X}_0$  to  $\mathbf{X}_1$  consists of all points of the form

$$\mathbf{X} = t(1, -1, -1) + (1 - t)(-1, 3, -1), \quad 0 \leq t \leq 1.$$

These familiar notions can be generalized to  $\mathbb{R}^n$ , as follows:

**Definition 5.1.10** Suppose that  $\mathbf{X}_0$  and  $\mathbf{U}$  are in  $\mathbb{R}^n$  and  $\mathbf{U} \neq \mathbf{0}$ . Then *the line through  $\mathbf{X}_0$  in the direction of  $\mathbf{U}$*  is the set of all points in  $\mathbb{R}^n$  of the form

$$\mathbf{X} = \mathbf{X}_0 + t\mathbf{U}, \quad -\infty < t < \infty.$$

A set of points of the form

$$\mathbf{X} = \mathbf{X}_0 + t\mathbf{U}, \quad t_1 \leq t \leq t_2,$$

is called a *line segment*. In particular, the line segment from  $\mathbf{X}_0$  to  $\mathbf{X}_1$  is the set of points of the form

$$\mathbf{X} = \mathbf{X}_0 + t(\mathbf{X}_1 - \mathbf{X}_0) = t\mathbf{X}_1 + (1 - t)\mathbf{X}_0, \quad 0 \leq t \leq 1.$$

## Nearby Neighborhoods and Open Sets in $\mathbb{R}^n$

Having defined distance in  $\mathbb{R}^n$ , we are now able to say what we mean by a neighborhood of a point in  $\mathbb{R}^n$ .

**Definition 5.1.11** If  $\epsilon > 0$ , the  $\epsilon$ -neighborhood of a point  $\mathbf{X}_0$  in  $\mathbb{R}^n$  is the set

$$N_\epsilon(\mathbf{X}_0) = \{\mathbf{X} \mid |\mathbf{X} - \mathbf{X}_0| < \epsilon\}. \quad \blacksquare$$

An  $\epsilon$ -neighborhood of a point  $\mathbf{X}_0$  in  $\mathbb{R}^2$  is the inside, but not the circumference, of the circle of radius  $\epsilon$  about  $\mathbf{X}_0$ . In  $\mathbb{R}^3$  it is the inside, but not the surface, of the sphere of radius  $\epsilon$  about  $\mathbf{X}_0$ .

In Section 1.3 we stated several other definitions in terms of  $\epsilon$ -neighborhoods: *neighborhood, interior point, interior of a set, open set, closed set, limit point, boundary point, boundary of a set, closure of a set, isolated point, exterior point, and exterior of a set*. Since these definitions are the same for  $\mathbb{R}^n$  as for  $\mathbb{R}$ , we will not repeat them. We advise you to read them again in Section 1.3, substituting  $\mathbb{R}^n$  for  $\mathbb{R}$  and  $\mathbf{X}_0$  for  $x_0$ .

**Example 5.1.6** Let  $S$  be the set of points in  $\mathbb{R}^2$  in the square bounded by the lines  $x = \pm 1$ ,  $y = \pm 1$ , except for the origin and the points on the vertical lines  $x = \pm 1$  (Figure 5.1.4, page 290); thus,

$$S = \{(x, y) \mid (x, y) \neq (0, 0), -1 < x < 1, -1 \leq y \leq 1\}.$$

Every point of  $S$  not on the lines  $y = \pm 1$  is an interior point, so

$$S^0 = \{(x, y) \mid (x, y) \neq (0, 0), -1 < x, y < 1\}.$$

$S$  is a deleted neighborhood of  $(0, 0)$  and is neither open nor closed. The closure of  $S$  is

$$\bar{S} = \{(x, y) \mid -1 \leq x, y \leq 1\},$$

and every point of  $\bar{S}$  is a limit point of  $S$ . The origin and the perimeter of  $S$  form  $\partial S$ , the boundary of  $S$ . The exterior of  $S$  consists of all points  $(x, y)$  such that  $|x| > 1$  or  $|y| > 1$ . The origin is an isolated point of  $S^c$ .

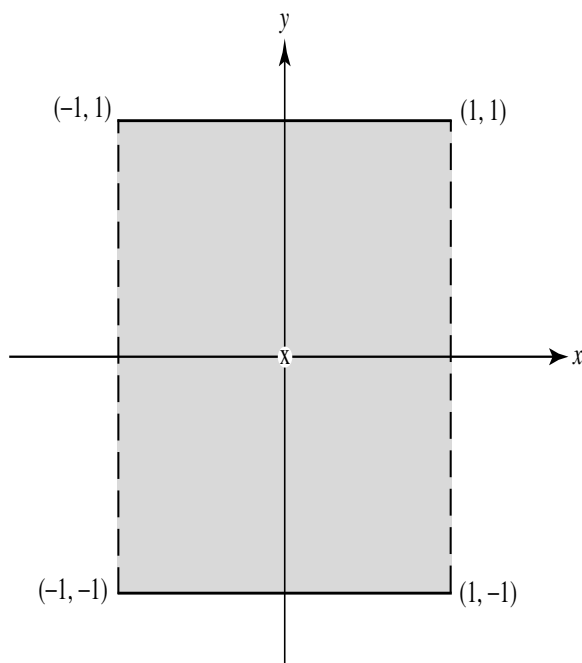


Figure 5.1.4

**Example 5.1.7** If  $\mathbf{X}_0$  is a point in  $\mathbb{R}^n$  and  $r$  is a positive number, the *open  $n$ -ball of radius  $r$  about  $\mathbf{X}_0$*  is the set  $B_r(\mathbf{X}_0) = \{\mathbf{X} \mid |\mathbf{X} - \mathbf{X}_0| < r\}$ . (Thus,  $\epsilon$ -neighborhoods are open  $n$ -balls.) If  $\mathbf{X}_1$  is in  $S_r(\mathbf{X}_0)$  and

$$|\mathbf{X} - \mathbf{X}_1| < \epsilon = r - |\mathbf{X} - \mathbf{X}_0|,$$

then  $\mathbf{X}$  is in  $S_r(\mathbf{X}_0)$ . (The situation is depicted in Figure 5.1.5 for  $n = 2$ .)

Thus,  $S_r(\mathbf{X}_0)$  contains an  $\epsilon$ -neighborhood of each of its points, and is therefore open. We leave it to you (Exercise 5.1.13) to show that the closure of  $B_r(\mathbf{X}_0)$  is the *closed  $n$ -ball of radius  $r$  about  $\mathbf{X}_0$* , defined by

$$\bar{S}_r(\mathbf{X}_0) = \{\mathbf{X} \mid |\mathbf{X} - \mathbf{X}_0| \leq r\}.$$

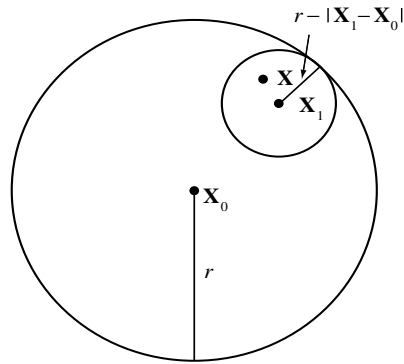


Figure 5.1.5

Open and closed  $n$ -balls are generalizations to  $\mathbb{R}^n$  of open and closed intervals.

The following lemma will be useful later in this section, when we consider connected sets.

**Lemma 5.1.12** *If  $\mathbf{X}_1$  and  $\mathbf{X}_2$  are in  $S_r(\mathbf{X}_0)$  for some  $r > 0$ , then so is every point on the line segment from  $\mathbf{X}_1$  to  $\mathbf{X}_2$ .*

**Proof** The line segment is given by

$$\mathbf{X} = t\mathbf{X}_2 + (1-t)\mathbf{X}_1, \quad 0 < t < 1.$$

Suppose that  $r > 0$ . If

$$|\mathbf{X}_1 - \mathbf{X}_0| < r, \quad |\mathbf{X}_2 - \mathbf{X}_0| < r,$$

and  $0 < t < 1$ , then

$$\begin{aligned} |\mathbf{X} - \mathbf{X}_0| &= |t\mathbf{X}_2 + (1-t)\mathbf{X}_1 - t\mathbf{X}_0 - (1-t)\mathbf{X}_0| \\ &= |t(\mathbf{X}_2 - \mathbf{X}_0) + (1-t)(\mathbf{X}_1 - \mathbf{X}_0)| \\ &\leq t|\mathbf{X}_2 - \mathbf{X}_0| + (1-t)|\mathbf{X}_1 - \mathbf{X}_0| \\ &< tr + (1-t)r = r. \end{aligned}$$

■

The proofs in Section 1.3 of Theorem 1.3.3 (the union of open sets is open, the intersection of closed sets is closed) and Theorem 1.3.5 and its Corollary 1.3.6 (a set is closed if and only if it contains all its limit points) are also valid in  $\mathbb{R}^n$ . You should reread them now.

The Heine–Borel theorem (Theorem 1.3.7) also holds in  $\mathbb{R}^n$ , but the proof in Section 1.3 is valid only for  $n = 1$ . To prove the Heine–Borel theorem for general  $n$ , we need some preliminary definitions and results that are of interest in their own right.

**Definition 5.1.13** A sequence of points  $\{\mathbf{X}_r\}$  in  $\mathbb{R}^n$  converges to the limit  $\bar{\mathbf{X}}$  if

$$\lim_{r \rightarrow \infty} |\mathbf{X}_r - \bar{\mathbf{X}}| = 0.$$

In this case we write

$$\lim_{r \rightarrow \infty} \mathbf{X}_r = \bar{\mathbf{X}}. \quad \blacksquare$$

The next two theorems follow from this, the definition of distance in  $\mathbb{R}^n$ , and what we already know about convergence in  $\mathbb{R}$ . We leave the proofs to you (Exercises 5.1.16 and 5.1.17).

**Theorem 5.1.14** Let

$$\bar{\mathbf{X}} = (\bar{x}_1, \bar{x}_2, \dots, \bar{x}_n) \quad \text{and} \quad \mathbf{X}_r = (x_{1r}, x_{2r}, \dots, x_{nr}), \quad r \geq 1.$$

Then  $\lim_{r \rightarrow \infty} \mathbf{X}_r = \bar{\mathbf{X}}$  if and only if

$$\lim_{r \rightarrow \infty} x_{ir} = \bar{x}_i, \quad 1 \leq i \leq n;$$

that is, a sequence  $\{\mathbf{X}_r\}$  of points in  $\mathbb{R}^n$  converges to a limit  $\bar{\mathbf{X}}$  if and only if the sequences of components of  $\{\mathbf{X}_r\}$  converge to the respective components of  $\bar{\mathbf{X}}$ .

**Theorem 5.1.15 (Cauchy's Convergence Criterion)** A sequence  $\{\mathbf{X}_r\}$  in  $\mathbb{R}^n$  converges if and only if for each  $\epsilon > 0$  there is an integer  $K$  such that

$$|\mathbf{X}_r - \mathbf{X}_s| < \epsilon \quad \text{if} \quad r, s \geq K.$$

The next definition generalizes the definition of the diameter of a circle or sphere.

**Definition 5.1.16** If  $S$  is a nonempty subset of  $\mathbb{R}^n$ , then

$$d(S) = \sup \{|\mathbf{X} - \mathbf{Y}| \mid \mathbf{X}, \mathbf{Y} \in S\}$$

is the *diameter* of  $S$ . If  $d(S) < \infty$ ,  $S$  is *bounded*; if  $d(S) = \infty$ ,  $S$  is *unbounded*.

**Theorem 5.1.17 (Principle of Nested Sets)** If  $S_1, S_2, \dots$  are closed nonempty subsets of  $\mathbb{R}^n$  such that

$$S_1 \supset S_2 \supset \dots \supset S_r \supset \dots \quad (5.1.14)$$

and

$$\lim_{r \rightarrow \infty} d(S_r) = 0, \quad (5.1.15)$$

then the intersection

$$I = \bigcap_{r=1}^{\infty} S_r$$

contains exactly one point.

**Proof** Let  $\{\mathbf{X}_r\}$  be a sequence such that  $\mathbf{X}_r \in S_r$  ( $r \geq 1$ ). Because of (5.1.14),  $\mathbf{X}_r \in S_k$  if  $r \geq k$ , so

$$|\mathbf{X}_r - \mathbf{X}_s| < d(S_k) \quad \text{if } r, s \geq k.$$

From (5.1.15) and Theorem 5.1.15,  $\mathbf{X}_r$  converges to a limit  $\bar{\mathbf{X}}$ . Since  $\bar{\mathbf{X}}$  is a limit point of every  $S_k$  and every  $S_k$  is closed,  $\bar{\mathbf{X}}$  is in every  $S_k$  (Corollary 1.3.6). Therefore,  $\bar{\mathbf{X}} \in I$ , so  $I \neq \emptyset$ . Moreover,  $\bar{\mathbf{X}}$  is the only point in  $I$ , since if  $\mathbf{Y} \in I$ , then

$$|\bar{\mathbf{X}} - \mathbf{Y}| \leq d(S_k), \quad k \geq 1,$$

and (5.1.15) implies that  $\mathbf{Y} = \bar{\mathbf{X}}$ . ■

We can now prove the Heine–Borel theorem for  $\mathbb{R}^n$ . This theorem concerns *compact* sets. As in  $\mathbb{R}$ , a compact set in  $\mathbb{R}^n$  is a closed and bounded set.

Recall that a collection  $\mathcal{H}$  of open sets is an open covering of a set  $S$  if

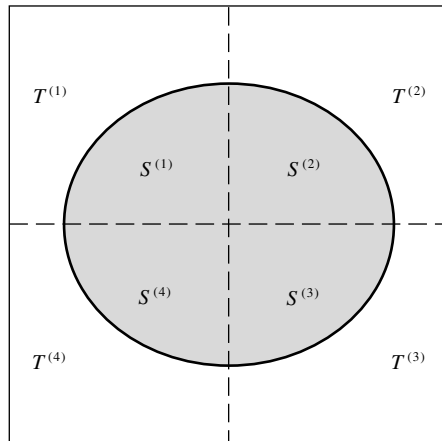
$$S \subset \cup \{H \mid H \in \mathcal{H}\}.$$

**Theorem 5.1.18 (Heine–Borel Theorem)** *If  $\mathcal{H}$  is an open covering of a compact subset  $S$ , then  $S$  can be covered by finitely many sets from  $\mathcal{H}$ .*

**Proof** The proof is by contradiction. We first consider the case where  $n = 2$ , so that you can visualize the method. Suppose that there is a covering  $\mathcal{H}$  for  $S$  from which it is impossible to select a finite subcovering. Since  $S$  is bounded,  $S$  is contained in a closed square

$$T = \{(x, y) \mid a_1 \leq x \leq a_1 + L, a_2 \leq y \leq a_2 + L\}$$

with sides of length  $L$  (Figure 5.1.6).



**Figure 5.1.6**

Bisecting the sides of  $T$  as shown by the dashed lines in Figure 5.1.6 leads to four closed squares,  $T^{(1)}$ ,  $T^{(2)}$ ,  $T^{(3)}$ , and  $T^{(4)}$ , with sides of length  $L/2$ . Let

$$S^{(i)} = S \cap T^{(i)}, \quad 1 \leq i \leq 4.$$

Each  $S^{(i)}$ , being the intersection of closed sets, is closed, and

$$S = \bigcup_{i=1}^4 S^{(i)}.$$

Moreover,  $\mathcal{H}$  covers each  $S^{(i)}$ , but at least one  $S^{(i)}$  cannot be covered by any finite subcollection of  $\mathcal{H}$ , since if all the  $S^{(i)}$  could be, then so could  $S$ . Let  $S_1$  be a set with this property, chosen from  $S^{(1)}$ ,  $S^{(2)}$ ,  $S^{(3)}$ , and  $S^{(4)}$ . We are now back to the situation we started from: a compact set  $S_1$  covered by  $\mathcal{H}$ , but not by any finite subcollection of  $\mathcal{H}$ . However,  $S_1$  is contained in a square  $T_1$  with sides of length  $L/2$  instead of  $L$ . Bisecting the sides of  $T_1$  and repeating the argument, we obtain a subset  $S_2$  of  $S_1$  that has the same properties as  $S$ , except that it is contained in a square with sides of length  $L/4$ . Continuing in this way produces a sequence of nonempty closed sets  $S_0 (= S)$ ,  $S_1$ ,  $S_2$ ,  $\dots$ , such that  $S_k \supset S_{k+1}$  and  $d(S_k) \leq L/2^{k-1/2}$  ( $k \geq 0$ ). From Theorem 5.1.17, there is a point  $\bar{\mathbf{X}}$  in  $\bigcap_{k=1}^{\infty} S_k$ . Since  $\bar{\mathbf{X}} \in S$ , there is an open set  $H$  in  $\mathcal{H}$  that contains  $\bar{\mathbf{X}}$ , and this  $H$  must also contain some  $\epsilon$ -neighborhood of  $\bar{\mathbf{X}}$ . Since every  $\mathbf{X}$  in  $S_k$  satisfies the inequality

$$|\mathbf{X} - \bar{\mathbf{X}}| \leq 2^{-k+1/2}L,$$

it follows that  $S_k \subset H$  for  $k$  sufficiently large. This contradicts our assumption on  $\mathcal{H}$ , which led us to believe that no  $S_k$  could be covered by a finite number of sets from  $\mathcal{H}$ . Consequently, this assumption must be false:  $\mathcal{H}$  must have a finite subcollection that covers  $S$ . This completes the proof for  $n = 2$ .

The idea of the proof is the same for  $n > 2$ . The counterpart of the square  $T$  is the *hypercube* with sides of length  $L$ :

$$T = \{(x_1, x_2, \dots, x_n) \mid a_i \leq x_i \leq a_i + L, i = 1, 2, \dots, n\}.$$

Halving the intervals of variation of the  $n$  coordinates  $x_1, x_2, \dots, x_n$  divides  $T$  into  $2^n$  closed hypercubes with sides of length  $L/2$ :

$$T^{(i)} = \{(x_1, x_2, \dots, x_n) \mid b_i \leq x_i \leq b_i + L/2, 1 \leq i \leq n\},$$

where  $b_i = a_i$  or  $b_i = a_i + L/2$ . If no finite subcollection of  $\mathcal{H}$  covers  $S$ , then at least one of these smaller hypercubes must contain a subset of  $S$  that is not covered by any finite subcollection of  $S$ . Now the proof proceeds as for  $n = 2$ . ■

The Bolzano–Weierstrass theorem is valid in  $\mathbb{R}^n$ ; its proof is the same as in  $\mathbb{R}$ .

## Connected Sets and Regions

Although it is legitimate to consider functions defined on arbitrary domains, we restricted

our study of functions of one variable mainly to functions defined on intervals. There are good reasons for this. If we wish to raise questions of continuity and differentiability at every point of the domain  $D$  of a function  $f$ , then every point of  $D$  must be a limit point of  $D^0$ . Intervals have this property. Moreover, the definition of  $\int_a^b f(x) dx$  is obviously applicable only if  $f$  is defined on  $[a, b]$ .

It is not productive to consider questions of continuity and differentiability of functions defined on the union of disjoint intervals, since many important results simply do not hold for such domains. For example, the intermediate value theorem (Theorem 2.2.10; see also Exercise 2.2.25) says that if  $f$  is continuous on an interval  $I$  and  $f(x_1) < \mu < f(x_2)$  for some  $x_1$  and  $x_2$  in  $I$ , then  $f(\bar{x}) = \mu$  for some  $\bar{x}$  in  $I$ . Theorem 2.3.12 says that  $f$  is constant on an interval  $I$  if  $f' \equiv 0$  on  $I$ . Neither of these results holds if  $I$  is the union of disjoint intervals rather than a single interval; thus, if  $f$  is defined on  $I = (0, 1) \cup (2, 3)$  by

$$f(x) = \begin{cases} 1, & 0 < x < 1, \\ 0, & 2 < x < 3, \end{cases}$$

then  $f$  is continuous on  $I$ , but does not assume any value between 0 and 1, and  $f' \equiv 0$  on  $I$ , but  $f$  is not constant.

It is not difficult to see why these results fail to hold for this function: the domain of  $f$  consists of two disconnected pieces. It would be more sensible to regard  $f$  as two entirely different functions, one defined on  $(0, 1)$  and the other on  $(2, 3)$ . The two results mentioned are valid for each of these functions.

As we will see when we study functions defined on subsets of  $\mathbb{R}^n$ , considerations like those just cited as making it natural to consider functions defined on intervals in  $\mathbb{R}$  lead us to single out a preferred class of subsets as domains of functions of  $n$  variables. These subsets are called *regions*. To define this term, we first need the following definition.

**Definition 5.1.19** A subset  $S$  of  $\mathbb{R}^n$  is *connected* if it is impossible to represent  $S$  as the union of two disjoint nonempty sets such that neither contains a limit point of the other; that is, if  $S$  cannot be expressed as  $S = A \cup B$ , where

$$A \neq \emptyset, \quad B \neq \emptyset, \quad \bar{A} \cap B = \emptyset, \quad \text{and} \quad A \cap \bar{B} = \emptyset. \quad (5.1.16)$$

If  $S$  can be expressed in this way, then  $S$  is *disconnected*.

**Example 5.1.8** The empty set and singleton sets are connected, because they cannot be represented as the union of two disjoint nonempty sets.

**Example 5.1.9** The space  $\mathbb{R}^n$  is connected, because if  $\mathbb{R}^n = A \cup B$  with  $\bar{A} \cap B = \emptyset$  and  $A \cap \bar{B} = \emptyset$ , then  $\bar{A} \subset A$  and  $\bar{B} \subset B$ ; that is,  $A$  and  $B$  are both closed and therefore are both open. Since the only nonempty subset of  $\mathbb{R}^n$  that is both open and closed is  $\mathbb{R}^n$  itself (Exercise 5.1.21), one of  $A$  and  $B$  is  $\mathbb{R}^n$  and the other is empty.



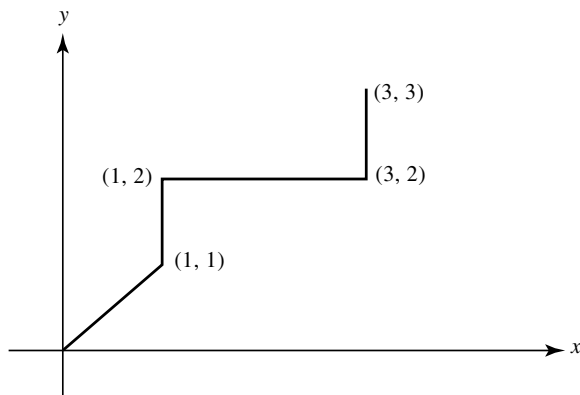


Figure 5.1.7

If  $\mathbf{X}_1, \mathbf{X}_2, \dots, \mathbf{X}_k$  are points in  $\mathbb{R}^n$  and  $L_i$  is the line segment from  $\mathbf{X}_i$  to  $\mathbf{X}_{i+1}$ ,  $1 \leq i \leq k-1$ , we say that  $L_1, L_2, \dots, L_{k-1}$  form a *polygonal path* from  $\mathbf{X}_1$  to  $\mathbf{X}_k$ , and that  $\mathbf{X}_1$  and  $\mathbf{X}_k$  are *connected* by the polygonal path. For example, Figure 5.1.7 shows a polygonal path in  $\mathbb{R}^2$  connecting  $(0, 0)$  to  $(3, 3)$ . A set  $S$  is *polygonally connected* if every pair of points in  $S$  can be connected by a polygonal path lying entirely in  $S$ .

**Theorem 5.1.20** *An open set  $S$  in  $\mathbb{R}^n$  is connected if and only if it is polygonally connected.*

**Proof** For sufficiency, we will show that if  $S$  is disconnected, then  $S$  is not polygonally connected. Let  $S = A \cup B$ , where  $A$  and  $B$  satisfy (5.1.16). Suppose that  $\mathbf{X}_1 \in A$  and  $\mathbf{X}_2 \in B$ , and assume that there is a polygonal path in  $S$  connecting  $\mathbf{X}_1$  to  $\mathbf{X}_2$ . Then some line segment  $L$  in this path must contain a point  $\mathbf{Y}_1$  in  $A$  and a point  $\mathbf{Y}_2$  in  $B$ . The line segment

$$\mathbf{X} = t\mathbf{Y}_2 + (1-t)\mathbf{Y}_1, \quad 0 \leq t \leq 1,$$

is part of  $L$  and therefore in  $S$ . Now define

$$\rho = \sup \{ \tau \mid t\mathbf{Y}_2 + (1-t)\mathbf{Y}_1 \in A, 0 \leq t \leq \tau \leq 1 \},$$

and let

$$\mathbf{X}_\rho = \rho\mathbf{Y}_2 + (1-\rho)\mathbf{Y}_1.$$

Then  $\mathbf{X}_\rho \in \overline{A \cap B}$ . However, since  $\mathbf{X}_\rho \in A \cup B$  and  $\overline{A \cap B} = A \cap \overline{B} = \emptyset$ , this is impossible. Therefore, the assumption that there is a polygonal path in  $S$  from  $\mathbf{X}_1$  to  $\mathbf{X}_2$  must be false.

For necessity, suppose that  $S$  is a connected open set and  $\mathbf{X}_0 \in S$ . Let  $A$  be the set consisting of  $\mathbf{X}_0$  and the points in  $S$  that can be connected to  $\mathbf{X}_0$  by polygonal paths in  $S$ . Let  $B$  be set of points in  $S$  that cannot be connected to  $\mathbf{X}_0$  by polygonal paths. If  $\mathbf{Y}_0 \in S$ , then  $S$  contains an  $\epsilon$ -neighborhood  $N_\epsilon(\mathbf{Y}_0)$  of  $\mathbf{Y}_0$ , since  $S$  is open. Any point  $\mathbf{Y}_1$  in  $N_\epsilon(\mathbf{Y}_0)$  can be connected to  $\mathbf{Y}_0$  by the line segment

$$\mathbf{X} = t\mathbf{Y}_1 + (1-t)\mathbf{Y}_0, \quad 0 \leq t \leq 1,$$

which lies in  $N_\epsilon(\mathbf{Y}_0)$  (Lemma 5.1.12) and therefore in  $S$ . This implies that  $\mathbf{Y}_0$  can be connected to  $\mathbf{X}_0$  by a polygonal path in  $S$  if and only if every member of  $N_\epsilon(\mathbf{Y}_0)$  can also. Thus,  $N_\epsilon(\mathbf{Y}_0) \subset A$  if  $\mathbf{Y}_0 \in A$ , and  $N_\epsilon(\mathbf{Y}_0) \subset B$  if  $\mathbf{Y}_0 \in B$ . Therefore,  $A$  and  $B$  are open. Since  $A \cap B = \emptyset$ , this implies that  $A \cap \overline{B} = \overline{A} \cap B = \emptyset$  (Exercise 5.1.14). Since  $A$  is nonempty ( $\mathbf{X}_0 \in A$ ), it now follows that  $B = \emptyset$ , since if  $B \neq \emptyset$ ,  $S$  would be disconnected (Definition 5.1.19). Therefore,  $A = S$ , which completes the proof of necessity. ■

We did not use the assumption that  $S$  is open in the proof of sufficiency. In fact, we actually proved that any polygonally connected set, open or not, is connected. The converse is false. A set (not open) may be connected but not polygonally connected (Exercise 5.1.29).

Our study of functions on  $\mathbb{R}^n$  will deal mostly with functions whose domains are regions, defined next.

**Definition 5.1.21** A region  $S$  in  $\mathbb{R}^n$  is the union of an open connected set with some, all, or none of its boundary; thus,  $S^0$  is connected, and every point of  $S$  is a limit point of  $S^0$ .

**Example 5.1.10** Intervals are the only regions in  $\mathbb{R}$  (Exercise 5.1.31). The  $n$ -ball  $B_r(\mathbf{X}_0)$  (Example 5.1.7) is a region in  $\mathbb{R}^n$ , as is its closure  $\overline{B}_r(\mathbf{X}_0)$ . The set

$$S = \{(x, y) \mid x^2 + y^2 \leq 1 \text{ or } x^2 + y^2 \geq 4\}$$

(Figure 5.1.8(a), page 298) is not a region in  $\mathbb{R}^2$ , since it is not connected. The set  $S_1$  obtained by adding the line segment

$$L_1: \quad \mathbf{X} = t(0, 2) + (1-t)(0, 1), \quad 0 < t < 1,$$

to  $S$  (Figure 5.1.8(b)) is connected but is not a region, since points on the line segment are not limit points of  $S_1^0$ . The set  $S_2$  obtained by adding to  $S_1$  the points in the first quadrant bounded by the circles  $x^2 + y^2 = 1$  and  $x^2 + y^2 = 4$  and the line segments  $L_1$  and

$$L_2: \quad \mathbf{X} = t(2, 0) + (1-t)(1, 0), \quad 0 < t < 1$$

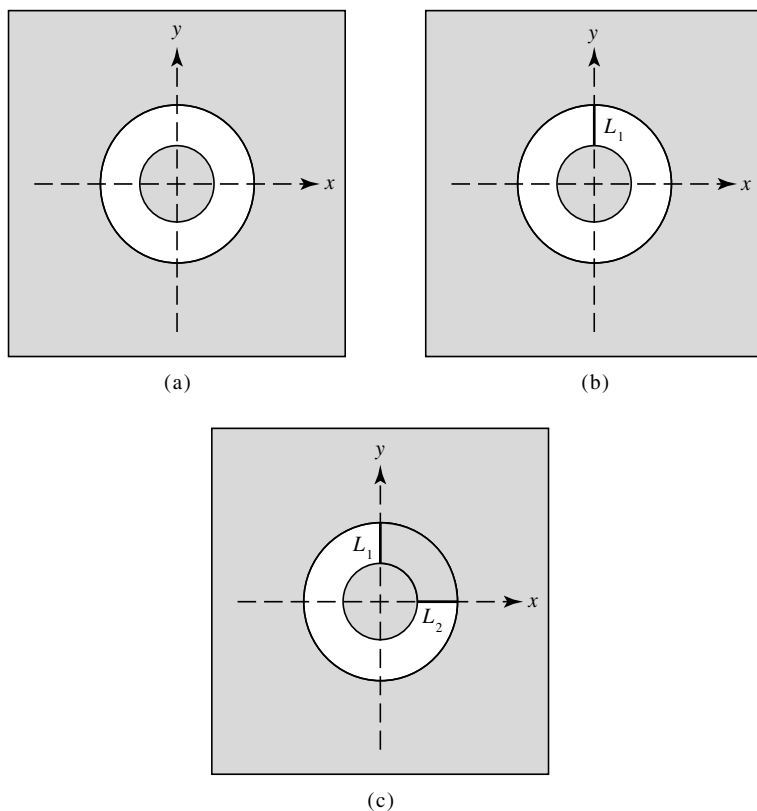
(Figure 5.1.8(c)), is a region.

### More about Sequences in $\mathbb{R}^n$

From Definition 5.1.13, a sequence  $\{\mathbf{X}_r\}$  of points in  $\mathbb{R}^n$  converges to a limit  $\overline{\mathbf{X}}$  if and only if for every  $\epsilon > 0$  there is an integer  $K$  such that

$$|\mathbf{X}_r - \overline{\mathbf{X}}| < \epsilon \quad \text{if } r \geq K.$$

The  $\mathbb{R}^n$  definitions of divergence, boundedness, subsequence, and sums, differences, and constant multiples of sequences are analogous to those given in Sections 4.1 and 4.2 for the case where  $n = 1$ . Since  $\mathbb{R}^n$  is not ordered for  $n > 1$ , monotonicity, limits inferior and superior of sequences in  $\mathbb{R}^n$ , and divergence to  $\pm\infty$  are undefined for  $n > 1$ . Products and quotients of members of  $\mathbb{R}^n$  are also undefined if  $n > 1$ .



**Figure 5.1.8**

Several theorems from Sections 4.1 and 4.2 remain valid for sequences in  $\mathbb{R}^n$ , with proofs unchanged, provided that “ $|\cdot|$ ” is interpreted as distance in  $\mathbb{R}^n$ . (A trivial change is required: the subscript  $n$ , used in Sections 4.1 and 4.2 to identify the terms of the sequence, must be replaced, since  $n$  here stands for the dimension of the space.) These include Theorems 4.1.2 (uniqueness of the limit), 4.1.4 (boundedness of a convergent sequence), parts of 4.1.8 (concerning limits of sums, differences, and constant multiples of convergent sequences), and 4.2.2 (every subsequence of a convergent sequence converges to the limit of the sequence).

## 5.1 Exercises

With  $\mathbb{R}$  replaced by  $\mathbb{R}^n$ , the following exercises from Section 1.3 are also suitable for this section: 1.3.7-1.3.10, 1.3.12-1.3.15, 1.3.19, 1.3.20 (except (e)), and 1.3.21.

- Find  $a\mathbf{X} + b\mathbf{Y}$ .
  - $\mathbf{X} = (1, 2, -3, 1)$ ,  $\mathbf{Y} = (0, -1, 2, 0)$ ,  $a = 3$ ,  $b = 6$
  - $\mathbf{X} = (1, -1, 2)$ ,  $\mathbf{Y} = (0, -1, 3)$ ,  $a = -1$ ,  $b = 2$
  - $\mathbf{X} = (\frac{1}{2}, \frac{3}{2}, \frac{1}{4}, \frac{1}{6})$ ,  $\mathbf{Y} = (-\frac{1}{2}, 1, 5, \frac{1}{3})$ ,  $a = \frac{1}{2}$ ,  $b = \frac{1}{6}$
- Prove Theorem 5.1.2.
- Find  $|\mathbf{X}|$ .
  - $(1, 2, -3, 1)$
  - $(\frac{1}{2}, \frac{1}{3}, \frac{1}{4}, \frac{1}{6})$
  - $(1, 2, -1, 3, 4)$
  - $(0, 1, 0, -1, 0, -1)$
- Find  $|\mathbf{X} - \mathbf{Y}|$ .
  - $\mathbf{X} = (3, 4, 5, -4)$ ,  $\mathbf{Y} = (2, 0, -1, 2)$
  - $\mathbf{X} = (-\frac{1}{2}, \frac{1}{2}, \frac{1}{4}, -\frac{1}{4})$ ,  $\mathbf{Y} = (\frac{1}{3}, -\frac{1}{6}, \frac{1}{6}, -\frac{1}{3})$
  - $\mathbf{X} = (0, 0, 0)$ ,  $\mathbf{Y} = (2, -1, 2)$
  - $\mathbf{X} = (3, -1, 4, 0, -1)$ ,  $\mathbf{Y} = (2, 0, 1, -4, 1)$
- Find  $\mathbf{X} \cdot \mathbf{Y}$ .
  - $\mathbf{X} = (3, 4, 5, -4)$ ,  $\mathbf{Y} = (3, 0, 3, 3)$
  - $\mathbf{X} = (\frac{1}{6}, \frac{11}{12}, \frac{9}{8}, \frac{5}{2})$ ,  $\mathbf{Y} = (-\frac{1}{2}, \frac{1}{2}, \frac{1}{4}, -\frac{1}{4})$
  - $\mathbf{X} = (1, 2, -3, 1, 4)$ ,  $\mathbf{Y} = (1, 2, -1, 3, 4)$
- Prove Theorem 5.1.9.
- Find a parametric equation of the line through  $\mathbf{X}_0$  in the direction of  $\mathbf{U}$ .
  - $\mathbf{X}_0 = (1, 2, -3, 1)$ ,  $\mathbf{U} = (3, 4, 5, -4)$
  - $\mathbf{X}_0 = (2, 0, -1, 2, 4)$ ,  $\mathbf{U} = (-1, 0, 1, 3, 2)$
  - $\mathbf{X}_0 = (-\frac{1}{2}, \frac{1}{2}, \frac{1}{4}, -\frac{1}{4})$ ,  $\mathbf{U} = (\frac{1}{3}, -\frac{1}{6}, \frac{1}{6}, -\frac{1}{3})$
- Suppose that  $\mathbf{U} \neq \mathbf{0}$  and  $\mathbf{V} \neq \mathbf{0}$ . Complete the sentence: The equations
 
$$\mathbf{X} = \mathbf{X}_0 + t\mathbf{U}, \quad -\infty < t < \infty,$$
 and
 
$$\mathbf{X} = \mathbf{X}_1 + s\mathbf{V}, \quad -\infty < s < \infty,$$
 represent the same line in  $\mathbb{R}^n$  if and only if ...
- Find the equation of the line segment from  $\mathbf{X}_0$  to  $\mathbf{X}_1$ .
  - $\mathbf{X}_0 = (1, -3, 4, 2)$ ,  $\mathbf{X}_1 = (2, 0, -1, 5)$
  - $\mathbf{X}_0 = (3, 1 - 2, 1, 4)$ ,  $\mathbf{X}_1 = (2, 0, -1, 4, -3)$
  - $\mathbf{X}_0 = (1, 2, -1)$ ,  $\mathbf{X}_1 = (0, -1, -1)$

10. Find  $\sup \{\epsilon \mid N_\epsilon(\mathbf{X}_0) \subset S\}$ .
- (a)  $\mathbf{X}_0 = (1, 2, -1, 3)$ ;  $S$  = the open 4-ball of radius 7 about  $(0, 3, -2, 2)$
- (b)  $\mathbf{X}_0 = (1, 2, -1, 3)$ ;  $S = \{(x_1, x_2, x_3, x_4) \mid |x_i| \leq 5, 1 \leq i \leq 4\}$
- (c)  $\mathbf{X}_0 = (3, \frac{5}{2})$ ;  $S$  = the closed triangle with vertices  $(2, 0)$ ,  $(2, 2)$ , and  $(4, 4)$
11. Find (i)  $\partial S$ ; (ii)  $\bar{S}$ ; (iii)  $S^0$ ; (iv) exterior of  $S$ .
- (a)  $S = \{(x_1, x_2, x_3, x_4) \mid |x_i| < 3, i = 1, 2, 3\}$
- (b)  $S = \{(x, y, 1) \mid x^2 + y^2 \leq 1\}$
12. Describe the following sets as open, closed, or neither.
- (a)  $S = \{(x_1, x_2, x_3, x_4) \mid |x_1| > 0, x_2 < 1, x_3 \neq -2\}$
- (b)  $S = \{(x_1, x_2, x_3, x_4) \mid x_1 = 1, x_3 \neq -4\}$
- (c)  $S = \{(x_1, x_2, x_3, x_4) \mid x_1 = 1, -3 \leq x_2 \leq 1, x_4 = -5\}$
13. Show that the closure of the open  $n$ -ball

$$B_r(\mathbf{X}_0) = \{\mathbf{X} \mid |\mathbf{X} - \mathbf{X}_0| < r\}$$

is the closed  $n$ -ball

$$\bar{B}_r(\mathbf{X}_0) = \{\mathbf{X} \mid |\mathbf{X} - \mathbf{X}_0| \leq r\}.$$

14. Prove: If  $A$  and  $B$  are open and  $A \cap B = \emptyset$ , then  $A \cap \bar{B} = \bar{A} \cap B = \emptyset$ .
15. Show that if  $\lim_{r \rightarrow \infty} \mathbf{X}_r$  exists, then it is unique.
16. Prove Theorem 5.1.14.
17. Prove Theorem 5.1.15.
18. Find  $\lim_{r \rightarrow \infty} \mathbf{X}_r$ .
- (a)  $\mathbf{X}_r = \left(r \sin \frac{\pi}{r}, \cos \frac{\pi}{r}, e^{-r}\right)$
- (b)  $\mathbf{X}_r = \left(1 - \frac{1}{r^2}, \log \frac{r+1}{r+2}, \left(1 + \frac{1}{r}\right)^r\right)$
19. Find  $d(S)$ .
- (a)  $S = \{(x, y, z) \mid |x| \leq 2, |y| \leq 1, |z - 2| \leq 2\}$
- (b)  $S = \left\{(x, y) \mid \frac{(x-1)^2}{9} + \frac{(y-2)^2}{4} = 1\right\}$
- (c)  $S$  = the triangle in  $\mathbb{R}^2$  with vertices  $(2, 0)$ ,  $(2, 2)$ , and  $(4, 4)$
- (d)  $S = \{(x_1, x_2, \dots, x_n) \mid |x_i| \leq L, i = 1, 2, \dots, n\}$
- (e)  $S = \{(x, y, z) \mid x \neq 0, |y| \leq 1, z > 2\}$
20. Prove that  $d(S) = d(\bar{S})$  for any set  $S$  in  $\mathbb{R}^n$ .
21. Prove: If a nonempty subset  $S$  of  $\mathbb{R}^n$  is both open and closed, then  $S = \mathbb{R}^n$ .

**22.** Use the Bolzano–Weierstrass theorem to show that if  $S_1, S_2, \dots, S_m, \dots$  is an infinite sequence of nonempty compact sets and  $S_1 \supset S_2 \supset \dots \supset S_m \supset \dots$ , then  $\bigcap_{m=1}^{\infty} S_m$  is nonempty. Show that the conclusion does not follow if the sets are assumed to be closed rather than compact.

**23.** Suppose that a sequence  $U_1, U_2, \dots$  of open sets covers a compact set  $S$ . Without using the Heine–Borel theorem, show that  $S \subset \bigcup_{m=1}^N U_m$  for some  $N$ . HINT: Apply Exercise 5.1.22 to the sets  $S_n = S \cap (\bigcup_{m=1}^n U_m)^c$ .

(This is a seemingly restricted version of the Heine–Borel theorem, valid for the case where the covering collection  $\mathcal{H}$  is denumerable. However, it can be shown that there is no loss of generality in assuming this.)

**24.** The distance from a point  $\mathbf{X}_0$  to a nonempty set  $S$  is defined by

$$\text{dist}(\mathbf{X}_0, S) = \inf \{ |\mathbf{X} - \mathbf{X}_0| \mid \mathbf{X} \in S \}.$$

(a) Prove: If  $S$  is closed and  $\mathbf{X}_0 \in \mathbb{R}^n$ , there is a point  $\bar{\mathbf{X}}$  in  $S$  such that

$$|\bar{\mathbf{X}} - \mathbf{X}_0| = \text{dist}(\mathbf{X}_0, S).$$

HINT: Apply Exercise 5.1.22 to the sets

$$C_m = \{ \mathbf{X} \mid \mathbf{X} \in S \text{ and } |\mathbf{X} - \mathbf{X}_0| \leq \text{dist}(\mathbf{X}_0, S) + 1/m \}, \quad m \geq 1.$$

(b) Show that if  $S$  is closed and  $\mathbf{X}_0 \notin S$ , then  $\text{dist}(\mathbf{X}_0, S) > 0$ .

(c) Show that the conclusions of (a) and (b) may fail to hold if  $S$  is not closed.

**25.** The distance between two nonempty sets  $S$  and  $T$  is defined by

$$\text{dist}(S, T) = \inf \{ |\mathbf{X} - \mathbf{Y}| \mid \mathbf{X} \in S, \mathbf{Y} \in T \}.$$

(a) Prove: If  $S$  is closed and  $T$  is compact, there are points  $\bar{\mathbf{X}}$  in  $S$  and  $\bar{\mathbf{Y}}$  in  $T$  such that

$$|\bar{\mathbf{X}} - \bar{\mathbf{Y}}| = \text{dist}(S, T).$$

HINT: Use Exercises 5.1.22 and 5.1.24.

(b) Under the assumptions of (a), show that  $\text{dist}(S, T) > 0$  if  $S \cap T = \emptyset$ .

(c) Show that the conclusions of (a) and (b) may fail to hold if  $S$  or  $T$  is not closed or  $T$  is unbounded.

**26.** (a) Prove: If a compact set  $S$  is contained in an open set  $U$ , there is a positive number  $r$  such that the set

$$S_r = \{ \mathbf{X} \mid \text{dist}(\mathbf{X}, S) \leq r \}$$

is contained in  $U$ . (You will need Exercise 5.1.24 here.)

(b) Show that  $S_r$  is compact.

27. Let  $D_1$  and  $D_2$  be compact subsets of  $\mathbb{R}^n$ . Show that

$$D = \{(\mathbf{X}, \mathbf{Y}) \mid \mathbf{X} \in D_1, \mathbf{Y} \in D_2\}$$

is a compact subset of  $\mathbb{R}^{2n}$ .

28. Prove: If  $S$  is open and  $S = A \cup B$  where  $\overline{A} \cap B = A \cap \overline{B} = \emptyset$ , then  $A$  and  $B$  are open.

29. Give an example of a connected set in  $\mathbb{R}^n$  that is not polygonally connected.

30. Prove that a region is connected.

31. Show that the intervals are the only regions in  $\mathbb{R}$ .

32. Prove: A bounded sequence in  $\mathbb{R}^n$  has a convergent subsequence. HINT: Use Theorems 5.1.14, 4.2.2, and 4.2.5(a).

33. Define “ $\lim_{r \rightarrow \infty} \mathbf{X}_r = \infty$ ” if  $\{\mathbf{X}_r\}$  is a sequence in  $\mathbb{R}^n$ ,  $n \geq 2$ .

## 5.2 CONTINUOUS REAL-VALUED FUNCTIONS OF $n$ VARIABLES

We now study real-valued functions of  $n$  variables. We denote the domain of a function  $f$  by  $D_f$  and the value of  $f$  at a point  $\mathbf{X} = (x_1, x_2, \dots, x_n)$  by  $f(\mathbf{X})$  or  $f(x_1, x_2, \dots, x_n)$ . We continue the convention adopted in Section 2.1 for functions of one variable: If a function is defined by a formula such as

$$f(\mathbf{X}) = (1 - x_1^2 - x_2^2 - \dots - x_n^2)^{1/2} \quad (5.2.1)$$

or

$$g(\mathbf{X}) = (1 - x_1^2 - x_2^2 - \dots - x_n^2)^{-1} \quad (5.2.2)$$

without specification of its domain, it is to be understood that its domain is the largest subset of  $\mathbb{R}^n$  for which the formula defines a unique real number. Thus, in the absence of any other stipulation, the domain of  $f$  in (5.2.1) is the closed  $n$ -ball  $\{\mathbf{X} \mid |\mathbf{X}| \leq 1\}$ , while the domain of  $g$  in (5.2.2) is the set  $\{\mathbf{X} \mid |\mathbf{X}| \neq 1\}$ .

The main objective of this section is to study limits and continuity of functions of  $n$  variables. The proofs of many of the theorems here are similar to the proofs of their counterparts in Sections 2.1 and . We leave most of them to you.

**Definition 5.2.1** We say that  $f(\mathbf{X})$  approaches the limit  $L$  as  $\mathbf{X}$  approaches  $\mathbf{X}_0$  and write

$$\lim_{\mathbf{X} \rightarrow \mathbf{X}_0} f(\mathbf{X}) = L$$

if  $\mathbf{X}_0$  is a limit point of  $D_f$  and, for every  $\epsilon > 0$ , there is a  $\delta > 0$  such that

$$|f(\mathbf{X}) - L| < \epsilon$$

for all  $\mathbf{X}$  in  $D_f$  such that

$$0 < |\mathbf{X} - \mathbf{X}_0| < \delta.$$

**Example 5.2.1** If

$$g(x, y) = 1 - x^2 - 2y^2,$$

then

$$\lim_{(x,y) \rightarrow (x_0,y_0)} g(x, y) = 1 - x_0^2 - 2y_0^2 \quad (5.2.3)$$

for every  $(x_0, y_0)$ . To see this, we write

$$\begin{aligned} |g(x, y) - (1 - x_0^2 - 2y_0^2)| &= |(1 - x^2 - 2y^2) - (1 - x_0^2 - 2y_0^2)| \\ &\leq |x^2 - x_0^2| + 2|y^2 - y_0^2| \\ &= |(x + x_0)(x - x_0)| + 2|(y + y_0)(y - y_0)| \\ &\leq |\mathbf{X} - \mathbf{X}_0|(|x + x_0| + 2|y + y_0|), \end{aligned} \quad (5.2.4)$$

since

$$|x - x_0| \leq |\mathbf{X} - \mathbf{X}_0| \quad \text{and} \quad |y - y_0| \leq |\mathbf{X} - \mathbf{X}_0|.$$

If  $|\mathbf{X} - \mathbf{X}_0| < 1$ , then  $|x| < |x_0| + 1$  and  $|y| < |y_0| + 1$ . This and (5.2.4) imply that

$$|g(x, y) - (1 - x_0^2 - 2y_0^2)| < K|\mathbf{X} - \mathbf{X}_0| \quad \text{if} \quad |\mathbf{X} - \mathbf{X}_0| < 1,$$

where

$$K = (2|x_0| + 1) + 2(2|y_0| + 1).$$

Therefore, if  $\epsilon > 0$  and

$$|\mathbf{X} - \mathbf{X}_0| < \delta = \min\{1, \epsilon/K\},$$

then

$$|g(x, y) - (1 - x_0^2 - 2y_0^2)| < \epsilon.$$

This proves (5.2.3). ■

Definition 5.2.1 does not require that  $f$  be defined at  $\mathbf{X}_0$ , or even on a deleted neighborhood of  $\mathbf{X}_0$ .

**Example 5.2.2** The function

$$h(x, y) = \frac{\sin \sqrt{1 - x^2 - 2y^2}}{\sqrt{1 - x^2 - 2y^2}}$$

is defined only on the interior of the region bounded by the ellipse

$$x^2 + 2y^2 = 1$$

(Figure 5.2.1(a), page 304). It is not defined at any point of the ellipse itself or on any deleted neighborhood of such a point. Nevertheless,

$$\lim_{(x,y) \rightarrow (x_0,y_0)} h(x, y) = 1 \quad (5.2.5)$$



if

$$x_0^2 + 2y_0^2 = 1. \quad (5.2.6)$$

To see this, let

$$u(x, y) = \sqrt{1 - x^2 - 2y^2}.$$

Then

$$h(x, y) = \frac{\sin u(x, y)}{u(x, y)}. \quad (5.2.7)$$

Recall that

$$\lim_{r \rightarrow 0} \frac{\sin r}{r} = 1;$$

therefore, if  $\epsilon > 0$ , there is a  $\delta_1 > 0$  such that

$$\left| \frac{\sin u}{u} - 1 \right| < \epsilon \quad \text{if} \quad 0 < |u| < \delta_1. \quad (5.2.8)$$

From (5.2.3),

$$\lim_{(x,y) \rightarrow (x_0,y_0)} (1 - x^2 - 2y^2) = 0$$

if (5.2.6) holds, so there is a  $\delta > 0$  such that

$$0 < u^2(x, y) = (1 - x^2 - 2y^2) < \delta_1^2$$

if  $\mathbf{X} = (x, y)$  is in the interior of the ellipse and  $|\mathbf{X} - \mathbf{X}_0| < \delta$ ; that is, if  $\mathbf{X}$  is in the shaded region of Figure 5.2.1(b).

Therefore,

$$0 < u = \sqrt{1 - x^2 - 2y^2} < \delta_1 \quad (5.2.9)$$

if  $\mathbf{X}$  is in the interior of the ellipse and  $|\mathbf{X} - \mathbf{X}_0| < \delta$ ; that is, if  $\mathbf{X}$  is in the shaded region of Figure 5.2.1(b). This, (5.2.7), and (5.2.8) imply that

$$|h(x, y) - 1| < \epsilon$$

for such  $\mathbf{X}$ , which implies (5.2.5).

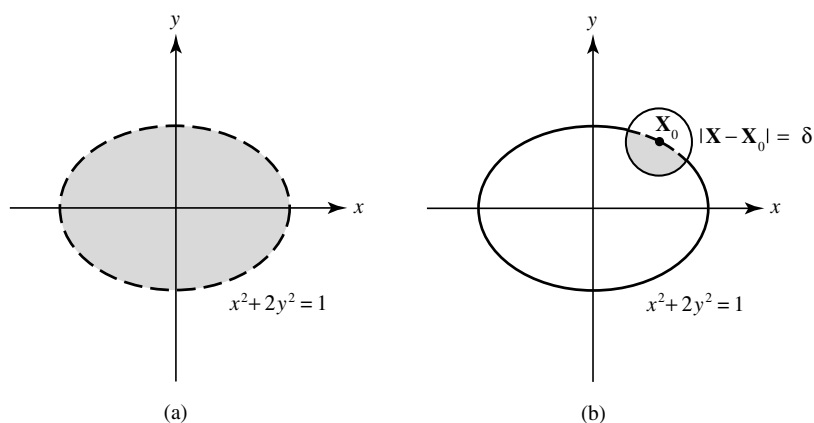


Figure 5.2.1

The following theorem is analogous to Theorem 2.1.3. We leave its proof to you (Exercise 5.2.2).

**Theorem 5.2.2** *If  $\lim_{\mathbf{X} \rightarrow \mathbf{X}_0} f(\mathbf{X})$  exists, then it is unique.*

When investigating whether a function has a limit at a point  $\mathbf{X}_0$ , no restriction can be made on the way in which  $\mathbf{X}$  approaches  $\mathbf{X}_0$ , except that  $\mathbf{X}$  must be in  $D_f$ . The next example shows that incorrect restrictions can lead to incorrect conclusions.

**Example 5.2.3** The function

$$f(x, y) = \frac{xy}{x^2 + y^2}$$

is defined everywhere in  $\mathbb{R}^2$  except at  $(0, 0)$ . Does  $\lim_{(x,y) \rightarrow (0,0)} f(x, y)$  exist? If we try to answer this question by letting  $(x, y)$  approach  $(0, 0)$  along the line  $y = x$ , we see the functional values

$$f(x, x) = \frac{x^2}{2x^2} = \frac{1}{2}$$

and conclude that the limit is  $1/2$ . However, if we let  $(x, y)$  approach  $(0, 0)$  along the line  $y = -x$ , we see the functional values

$$f(x, -x) = -\frac{x^2}{2x^2} = -\frac{1}{2}$$

and conclude that the limit equals  $-1/2$ . From Theorem 5.2.2, these two conclusions cannot both be correct. In fact, they are both incorrect. What we have shown is that

$$\lim_{x \rightarrow 0} f(x, x) = \frac{1}{2} \quad \text{and} \quad \lim_{x \rightarrow 0} f(x, -x) = -\frac{1}{2}.$$

Since  $\lim_{x \rightarrow 0} f(x, x)$  and  $\lim_{x \rightarrow 0} f(x, -x)$  must both equal  $\lim_{(x,y) \rightarrow (0,0)} f(x, y)$  if the latter exists (Exercise 5.2.3(a)), we conclude that the latter does not exist. ■

The sum, difference, and product of functions of  $n$  variables are defined in the same way as they are for functions of one variable (Definition 2.1.1), and the proof of the next theorem is the same as the proof of Theorem 2.1.4.

**Theorem 5.2.3** *Suppose that  $f$  and  $g$  are defined on a set  $D$ ,  $\mathbf{X}_0$  is a limit point of  $D$ , and*

$$\lim_{\mathbf{X} \rightarrow \mathbf{X}_0} f(\mathbf{X}) = L_1, \quad \lim_{\mathbf{X} \rightarrow \mathbf{X}_0} g(\mathbf{X}) = L_2.$$

*Then*

$$\lim_{\mathbf{X} \rightarrow \mathbf{X}_0} (f + g)(\mathbf{X}) = L_1 + L_2, \quad (5.2.10)$$

$$\lim_{\mathbf{X} \rightarrow \mathbf{X}_0} (f - g)(\mathbf{X}) = L_1 - L_2, \quad (5.2.11)$$

$$\lim_{\mathbf{X} \rightarrow \mathbf{X}_0} (fg)(\mathbf{X}) = L_1 L_2, \quad (5.2.12)$$

*and, if  $L_2 \neq 0$ ,*

$$\lim_{\mathbf{X} \rightarrow \mathbf{X}_0} \left( \frac{f}{g} \right)(\mathbf{X}) = \frac{L_1}{L_2}. \quad (5.2.13)$$

**Infinite Limits and Limits as  $|\mathbf{X}| \rightarrow \infty$** 

**Definition 5.2.4** We say that  $f(\mathbf{X})$  approaches  $\infty$  as  $\mathbf{X}$  approaches  $\mathbf{X}_0$  and write

$$\lim_{\mathbf{X} \rightarrow \mathbf{X}_0} f(\mathbf{X}) = \infty$$

if  $\mathbf{X}_0$  is a limit point of  $D_f$  and, for every real number  $M$ , there is a  $\delta > 0$  such that

$$f(\mathbf{X}) > M \quad \text{whenever} \quad 0 < |\mathbf{X} - \mathbf{X}_0| < \delta \quad \text{and} \quad \mathbf{X} \in D_f.$$

We say that

$$\lim_{\mathbf{X} \rightarrow \mathbf{X}_0} f(\mathbf{X}) = -\infty$$

if

$$\lim_{\mathbf{X} \rightarrow \mathbf{X}_0} (-f)(\mathbf{X}) = \infty.$$

**Example 5.2.4** If

$$f(\mathbf{X}) = (1 - x_1^2 - x_2^2 - \cdots - x_n^2)^{-1/2},$$

then

$$\lim_{\mathbf{X} \rightarrow \mathbf{X}_0} f(\mathbf{X}) = \infty$$

if  $|\mathbf{X}_0| = 1$ , because

$$f(\mathbf{X}) = \frac{1}{|\mathbf{X} - \mathbf{X}_0|},$$

so

$$f(\mathbf{X}) > M \quad \text{if} \quad 0 < |\mathbf{X} - \mathbf{X}_0| < \delta = \frac{1}{M}.$$

**Example 5.2.5** If

$$f(x, y) = \frac{1}{x + 2y + 1},$$

then  $\lim_{(x,y) \rightarrow (1,-1)} f(x, y)$  does not exist (why not?), but

$$\lim_{(x,y) \rightarrow (1,-1)} |f(x, y)| = \infty.$$

To see this, we observe that

$$\begin{aligned} |x + 2y + 1| &= |(x - 1) + 2(y + 1)| \\ &\leq \sqrt{5}|\mathbf{X} - \mathbf{X}_0| \quad (\text{by Schwarz's inequality}), \end{aligned}$$

where  $\mathbf{X}_0 = (1, -1)$ , so

$$|f(x, y)| = \frac{1}{|x + 2y + 1|} \geq \frac{1}{\sqrt{5}|\mathbf{X} - \mathbf{X}_0|}.$$

Therefore,

$$|f(x, y)| > M \quad \text{if} \quad 0 < |\mathbf{X} - \mathbf{X}_0| < \frac{1}{M\sqrt{5}}.$$

**Example 5.2.6** The function

$$f(x, y, z) = \frac{\left| \sin \left( \frac{1}{x^2 + y^2 + z^2} \right) \right|}{x^2 + y^2 + z^2}$$

assumes arbitrarily large values in every neighborhood of  $(0, 0, 0)$ . For example, if  $\mathbf{X}_k = (x_k, y_k, z_k)$ , where

$$x_k = y_k = z_k = \frac{1}{\sqrt{3(k + \frac{1}{2})\pi}},$$

then

$$f(\mathbf{X}_k) = \left(k + \frac{1}{2}\right)\pi.$$

However, this does not imply that  $\lim_{\mathbf{X} \rightarrow \mathbf{0}} f(\mathbf{X}) = \infty$ , since, for example, every neighborhood of  $(0, 0, 0)$  also contains points

$$\bar{\mathbf{X}}_k = \left( \frac{1}{\sqrt{3k\pi}}, \frac{1}{\sqrt{3k\pi}}, \frac{1}{\sqrt{3k\pi}} \right)$$

for which  $f(\bar{\mathbf{X}}_k) = 0$ .

**Definition 5.2.5** If  $D_f$  is unbounded, we say that

$$\lim_{|\mathbf{X}| \rightarrow \infty} f(\mathbf{X}) = L \quad (\text{finite})$$

if for every  $\epsilon > 0$ , there is a number  $R$  such that

$$|f(\mathbf{X}) - L| < \epsilon \quad \text{whenever} \quad |\mathbf{X}| \geq R \quad \text{and} \quad \mathbf{X} \in D_f.$$

**Example 5.2.7** If

$$f(x, y, z) = \cos \left( \frac{1}{x^2 + 2y^2 + z^2} \right),$$

then

$$\lim_{|\mathbf{X}| \rightarrow \infty} f(\mathbf{X}) = 1. \quad (5.2.14)$$

To see this, we recall that the continuity of  $\cos u$  at  $u = 0$  implies that for each  $\epsilon > 0$  there is a  $\delta > 0$  such that

$$|\cos u - 1| < \epsilon \quad \text{if} \quad |u| < \delta.$$

Since

$$\frac{1}{x^2 + 2y^2 + z^2} \leq \frac{1}{|\mathbf{X}|^2},$$

it follows that if  $|\mathbf{X}| > 1/\sqrt{\delta}$ , then

$$\frac{1}{x^2 + 2y^2 + z^2} < \delta.$$

Therefore,

$$|f(\mathbf{X}) - 1| < \epsilon.$$

This proves (5.2.14).

**Example 5.2.8** Consider the function defined *only* on the domain

$$D = \{(x, y) \mid 0 < y \leq ax\}, \quad 0 < a < 1$$

(Figure 5.2.2), by

$$f(x, y) = \frac{1}{x - y}.$$

We will show that

$$\lim_{|\mathbf{X}| \rightarrow \infty} f(x, y) = 0. \quad (5.2.15)$$

It is important to keep in mind that we need only consider  $(x, y)$  in  $D$ , since  $f$  is not defined elsewhere.

In  $D$ ,

$$x - y \geq x(1 - a) \quad (5.2.16)$$

and

$$|\mathbf{X}|^2 = x^2 + y^2 \leq x^2(1 + a^2),$$

so

$$x \geq \frac{|\mathbf{X}|}{\sqrt{1 + a^2}}.$$

This and (5.2.16) imply that

$$x - y \geq \frac{1 - a}{\sqrt{1 + a^2}} |\mathbf{X}|, \quad \mathbf{X} \in D,$$

so

$$|f(x, y)| \leq \frac{\sqrt{1 + a^2}}{1 - a} \frac{1}{|\mathbf{X}|}, \quad \mathbf{X} \in D.$$

Therefore,

$$|f(x, y)| < \epsilon$$

if  $\mathbf{X} \in D$  and

$$|\mathbf{X}| > \frac{\sqrt{1 + a^2}}{1 - a} \frac{1}{\epsilon}.$$

This implies (5.2.15).

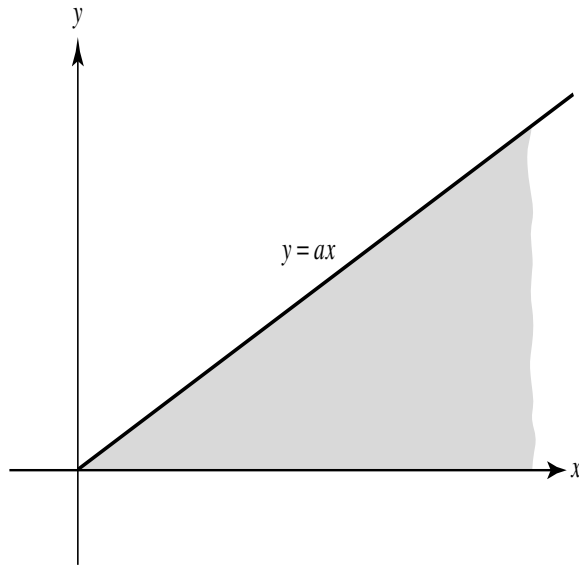


Figure 5.2.2

We leave it to you to define  $\lim_{|\mathbf{X}| \rightarrow \infty} f(\mathbf{X}) = \infty$  and  $\lim_{|\mathbf{X}| \rightarrow \infty} f(\mathbf{X}) = -\infty$  (Exercise 5.2.6).

We will continue the convention adopted in Section 2.1: “ $\lim_{\mathbf{X} \rightarrow \mathbf{X}_0} f(\mathbf{X})$  exists” means that  $\lim_{\mathbf{X} \rightarrow \mathbf{X}_0} f(\mathbf{X}) = L$ , where  $L$  is finite; to leave open the possibility that  $L = \pm\infty$ , we will say that “ $\lim_{\mathbf{X} \rightarrow \mathbf{X}_0} f(\mathbf{X})$  exists in the extended reals.” A similar convention applies to limits as  $|\mathbf{X}| \rightarrow \infty$ .

Theorem 5.2.3 remains valid if “ $\lim_{\mathbf{X} \rightarrow \mathbf{X}_0}$ ” is replaced by “ $\lim_{|\mathbf{X}| \rightarrow \infty}$ ,” provided that  $D$  is unbounded. Moreover, (5.2.10), (5.2.11), and (5.2.12) are valid in either version of Theorem 5.2.3 if either or both of  $L_1$  and  $L_2$  is infinite, provided that their right sides are not indeterminate, and (5.2.13) remains valid if  $L_2 \neq 0$  and  $L_1/L_2$  is not indeterminate.

## Continuity

We now define continuity for functions of  $n$  variables. The definition is quite similar to the definition for functions of one variable.

**Definition 5.2.6** If  $\mathbf{X}_0$  is in  $D_f$  and is a limit point of  $D_f$ , then we say that  $f$  is *continuous at  $\mathbf{X}_0$*  if

$$\lim_{\mathbf{X} \rightarrow \mathbf{X}_0} f(\mathbf{X}) = f(\mathbf{X}_0). \quad \blacksquare$$

The next theorem follows from this and Definition 5.2.1.

**Theorem 5.2.7** Suppose that  $\mathbf{X}_0$  is in  $D_f$  and is a limit point of  $D_f$ . Then  $f$  is continuous at  $\mathbf{X}_0$  if and only if for each  $\epsilon > 0$  there is a  $\delta > 0$  such that

$$|f(\mathbf{X}) - f(\mathbf{X}_0)| < \epsilon$$

whenever

$$|\mathbf{X} - \mathbf{X}_0| < \delta \quad \text{and} \quad \mathbf{X} \in D_f.$$

In applying this theorem when  $\mathbf{X}_0 \in D_f^0$ , we will usually omit “and  $\mathbf{X} \in D_f$ ,” it being understood that  $S_\delta(\mathbf{X}_0) \subset D_f$ .

We will say that  $f$  is *continuous on  $S$*  if  $f$  is continuous at every point of  $S$ .

**Example 5.2.9** From Example 5.2.1, we now see that the function

$$f(x, y) = 1 - x^2 - 2y^2$$

is continuous on  $\mathbb{R}^2$ .

**Example 5.2.10** If we extend the definition of  $h$  in Example 5.2.2 so that

$$h(x, y) = \begin{cases} \frac{\sin \sqrt{1 - x^2 - 2y^2}}{\sqrt{1 - x^2 - 2y^2}}, & x^2 + 2y^2 < 1, \\ 1, & x^2 + 2y^2 = 1, \end{cases}$$

then it follows from Example 5.2.2 that  $h$  is continuous on the ellipse

$$x^2 + 2y^2 = 1.$$

We will see in Example 5.2.13 that  $h$  is also continuous on the interior of the ellipse.

**Example 5.2.11** It is impossible to define the function

$$f(x, y) = \frac{xy}{x^2 + y^2}$$

at the origin to make it continuous there, since we saw in Example 5.2.3 that

$$\lim_{(x,y) \rightarrow (0,0)} f(x, y)$$

does not exist.

Theorem 5.2.3 implies the next theorem, which is analogous to Theorem 2.2.5 and, like the latter, permits us to investigate continuity of a given function by regarding the function as the result of addition, subtraction, multiplication, and division of simpler functions.

**Theorem 5.2.8** *If  $f$  and  $g$  are continuous on a set  $S$  in  $\mathbb{R}^n$ , then so are  $f + g$ ,  $f - g$ , and  $fg$ . Also,  $f/g$  is continuous at each  $\mathbf{X}_0$  in  $S$  such that  $g(\mathbf{X}_0) \neq 0$ .*

### Vector-Valued Functions and Composite Functions

Suppose that  $g_1, g_2, \dots, g_n$  are real-valued functions defined on a subset  $T$  of  $\mathbb{R}^m$ , and define the *vector-valued function*  $\mathbf{G}$  on  $T$  by

$$\mathbf{G}(\mathbf{U}) = (g_1(\mathbf{U}), g_2(\mathbf{U}), \dots, g_n(\mathbf{U})), \quad \mathbf{U} \in T.$$

Then  $g_1, g_2, \dots, g_n$  are the *component functions* of  $\mathbf{G} = (g_1, g_2, \dots, g_n)$ . We say that

$$\lim_{\mathbf{U} \rightarrow \mathbf{U}_0} \mathbf{G}(\mathbf{U}) = \mathbf{L} = (L_1, L_2, \dots, L_n)$$

if

$$\lim_{\mathbf{U} \rightarrow \mathbf{U}_0} g_i(\mathbf{U}) = L_i, \quad 1 \leq i \leq n,$$

and that  $\mathbf{G}$  is *continuous* at  $\mathbf{U}_0$  if  $g_1, g_2, \dots, g_n$  are each continuous at  $\mathbf{U}_0$ .

The next theorem follows from Theorem 5.1.14 and Definitions 5.2.1 and 5.2.6. We omit the proof.

**Theorem 5.2.9** *For a vector-valued function  $\mathbf{G}$ ,*

$$\lim_{\mathbf{U} \rightarrow \mathbf{U}_0} \mathbf{G}(\mathbf{U}) = \mathbf{L}$$

*if and only if for each  $\epsilon > 0$  there is a  $\delta > 0$  such that*

$$|\mathbf{G}(\mathbf{U}) - \mathbf{L}| < \epsilon \quad \text{whenever} \quad 0 < |\mathbf{U} - \mathbf{U}_0| < \delta \quad \text{and} \quad \mathbf{U} \in D_{\mathbf{G}}.$$

*Similarly,  $\mathbf{G}$  is continuous at  $\mathbf{U}_0$  if and only if for each  $\epsilon > 0$  there is a  $\delta > 0$  such that*

$$|\mathbf{G}(\mathbf{U}) - \mathbf{G}(\mathbf{U}_0)| < \epsilon \quad \text{whenever} \quad |\mathbf{U} - \mathbf{U}_0| < \delta \quad \text{and} \quad \mathbf{U} \in D_{\mathbf{G}}.$$

The following theorem on the continuity of a composite function is analogous to Theorem 2.2.7.

**Theorem 5.2.10** *Let  $f$  be a real-valued function defined on a subset of  $\mathbb{R}^n$ , and let the vector-valued function  $\mathbf{G} = (g_1, g_2, \dots, g_n)$  be defined on a domain  $D_{\mathbf{G}}$  in  $\mathbb{R}^m$ . Let the set*

$$T = \{\mathbf{U} \mid \mathbf{U} \in D_{\mathbf{G}} \quad \text{and} \quad \mathbf{G}(\mathbf{U}) \in D_f\}$$

*(Figure 5.2.3), be nonempty, and define the real-valued composite function*

$$h = f \circ \mathbf{G}$$

*on  $T$  by*

$$h(\mathbf{U}) = f(\mathbf{G}(\mathbf{U})), \quad \mathbf{U} \in T.$$

*Now suppose that  $\mathbf{U}_0$  is in  $T$  and is a limit point of  $T$ ,  $\mathbf{G}$  is continuous at  $\mathbf{U}_0$ , and  $f$  is continuous at  $\mathbf{X}_0 = \mathbf{G}(\mathbf{U}_0)$ . Then  $h$  is continuous at  $\mathbf{U}_0$ .*



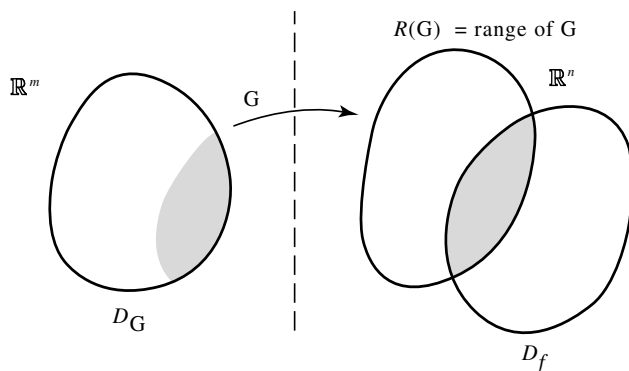


Figure 5.2.3

**Proof** Suppose that  $\epsilon > 0$ . Since  $f$  is continuous at  $\mathbf{X}_0 = \mathbf{G}(\mathbf{U}_0)$ , there is an  $\epsilon_1 > 0$  such that

$$|f(\mathbf{X}) - f(\mathbf{G}(\mathbf{U}_0))| < \epsilon \quad (5.2.17)$$

if

$$|\mathbf{X} - \mathbf{G}(\mathbf{U}_0)| < \epsilon_1 \quad \text{and} \quad \mathbf{X} \in D_f. \quad (5.2.18)$$

Since  $\mathbf{G}$  is continuous at  $\mathbf{U}_0$ , there is a  $\delta > 0$  such that

$$|\mathbf{G}(\mathbf{U}) - \mathbf{G}(\mathbf{U}_0)| < \epsilon_1 \quad \text{if} \quad |\mathbf{U} - \mathbf{U}_0| < \delta \quad \text{and} \quad \mathbf{U} \in D_G.$$

By taking  $\mathbf{X} = \mathbf{G}(\mathbf{U})$  in (5.2.17) and (5.2.18), we see that

$$|h(\mathbf{U}) - h(\mathbf{U}_0)| = |f(\mathbf{G}(\mathbf{U})) - f(\mathbf{G}(\mathbf{U}_0))| < \epsilon$$

if

$$|\mathbf{U} - \mathbf{U}_0| < \delta \quad \text{and} \quad \mathbf{U} \in T.$$

■

**Example 5.2.12** If

$$f(s) = \sqrt{s}$$

and

$$g(x, y) = 1 - x^2 - 2y^2,$$

then  $D_f = [0, \infty]$ ,  $D_g = \mathbb{R}^2$ , and

$$T = \{(x, y) \mid x^2 + 2y^2 \leq 1\}.$$

From Theorem 5.2.7 and Example 5.2.1,  $g$  is continuous on  $\mathbb{R}^2$ . (We can obtain the same conclusion by observing that the functions  $p_1(x, y) = x$  and  $p_2(x, y) = y$  are continuous on  $\mathbb{R}^2$  and applying Theorem 5.2.8.) Since  $f$  is continuous on  $D_f$ , the function

$$h(x, y) = f(g(x, y)) = \sqrt{1 - x^2 - 2y^2}$$

is continuous on  $T$ .

**Example 5.2.13** If

$$g(x, y) = \sqrt{1 - x^2 - 2y^2}$$

and

$$f(s) = \begin{cases} \frac{\sin s}{s}, & s \neq 0, \\ 1, & s = 0, \end{cases}$$

then  $D_f = (-\infty, \infty)$  and

$$D_g = T = \{(x, y) \mid x^2 + 2y^2 \leq 1\}.$$

In Example 5.2.12 we saw that  $g$  (we called it  $h$  there) is continuous on  $T$ . Since  $f$  is continuous on  $D_f$ , the composite function  $h = f \circ g$  defined by

$$h(x, y) = \begin{cases} \frac{\sin \sqrt{1 - x^2 - 2y^2}}{\sqrt{1 - x^2 - 2y^2}}, & x^2 + 2y^2 < 1, \\ 1, & x^2 + 2y^2 = 1, \end{cases}$$

is continuous on  $T$ . This implies the result of Example 5.2.2.

## Bounded Functions

The definitions of *bounded above*, *bounded below*, and *bounded* on a set  $S$  are the same for functions of  $n$  variables as for functions of one variable, as are the definitions of *supremum* and *infimum* of a function on a set  $S$  (Section 2.2). The proofs of the next two theorems are similar to those of Theorems 2.2.8 and 2.2.9 (Exercises 5.2.12 and 5.2.13).

**Theorem 5.2.11** *If  $f$  is continuous on a compact set  $S$  in  $\mathbb{R}^n$ , then  $f$  is bounded on  $S$ .*

**Theorem 5.2.12** *Let  $f$  be continuous on a compact set  $S$  in  $\mathbb{R}^n$  and*

$$\alpha = \inf_{\mathbf{X} \in S} f(\mathbf{X}), \quad \beta = \sup_{\mathbf{X} \in S} f(\mathbf{X}).$$

*Then*

$$f(\mathbf{X}_1) = \alpha \quad \text{and} \quad f(\mathbf{X}_2) = \beta$$

*for some  $\mathbf{X}_1$  and  $\mathbf{X}_2$  in  $S$ .*

The next theorem is analogous to Theorem 2.2.10.

**Theorem 5.2.13 (Intermediate Value Theorem)** *Let  $f$  be continuous on a region  $S$  in  $\mathbb{R}^n$ . Suppose that  $\mathbf{A}$  and  $\mathbf{B}$  are in  $S$  and*

$$f(\mathbf{A}) < u < f(\mathbf{B}).$$

*Then  $f(\mathbf{C}) = u$  for some  $\mathbf{C}$  in  $S$ .*

**Proof** If there is no such  $\mathbf{C}$ , then  $S = R \cup T$ , where

$$R = \{\mathbf{X} \mid \mathbf{X} \in S \text{ and } f(\mathbf{X}) < u\}$$

and

$$T = \{\mathbf{X} \mid \mathbf{X} \in S \text{ and } f(\mathbf{X}) > u\}.$$

If  $\mathbf{X}_0 \in R$ , the continuity of  $f$  implies that there is a  $\delta > 0$  such that  $f(\mathbf{X}) < u$  if  $|\mathbf{X} - \mathbf{X}_0| < \delta$  and  $\mathbf{X} \in S$ . This means that  $\mathbf{X}_0 \notin \overline{T}$ . Therefore,  $R \cap \overline{T} = \emptyset$ . Similarly,  $\overline{R} \cap T = \emptyset$ . Therefore,  $S$  is disconnected (Definition 5.1.19), which contradicts the assumption that  $S$  is a region (Exercise 5.1.30). Hence, we conclude that  $f(\mathbf{C}) = u$  for some  $\mathbf{C}$  in  $S$ . ■

### Uniform Continuity

The definition of uniform continuity for functions of  $n$  variables is the same as for functions of one variable;  $f$  is uniformly continuous on a subset  $S$  of its domain in  $\mathbb{R}^n$  if for every  $\epsilon > 0$  there is a  $\delta > 0$  such that

$$|f(\mathbf{X}) - f(\mathbf{X}')| < \epsilon$$

whenever  $|\mathbf{X} - \mathbf{X}'| < \delta$  and  $\mathbf{X}, \mathbf{X}' \in S$ . We emphasize again that  $\delta$  must depend only on  $\epsilon$  and  $S$ , and not on the particular points  $\mathbf{X}$  and  $\mathbf{X}'$ .

The proof of the next theorem is analogous to that of Theorem 2.2.12. We leave it to you (Exercise 5.2.14).

**Theorem 5.2.14** *If  $f$  is continuous on a compact set  $S$  in  $\mathbb{R}^n$ , then  $f$  is uniformly continuous on  $S$ .*

## 5.2 Exercises

With  $\mathbb{R}$  replaced by  $\mathbb{R}^n$ , the following exercises from Sections 2.1 and 2.2 have analogs for this section: 2.1.5, 2.1.8–2.1.11, 2.1.26, 2.1.28, 2.1.29, 2.1.33, 2.2.8, 2.2.9, 2.2.10, 2.2.15, 2.2.16, 2.2.20, 2.2.29, 2.2.30.

- Find  $\lim_{\mathbf{X} \rightarrow \mathbf{X}_0} f(\mathbf{X})$  and justify your answer with an  $\epsilon$ - $\delta$  argument, as required by Definition 5.2.1. HINT: See Examples 5.2.1 and 5.2.2.
  - $f(\mathbf{X}) = 3x + 4y + z - 2$ ,  $\mathbf{X}_0 = (1, 2, 1)$
  - $f(\mathbf{X}) = \frac{x^3 - y^3}{x - y}$ ,  $\mathbf{X}_0 = (1, 1)$
  - $f(\mathbf{X}) = \frac{\sin(x + 4y + 2z)}{x + 4y + 2z}$ ,  $\mathbf{X}_0 = (-2, 1, -1)$

(d)  $f(\mathbf{X}) = (x^2 + y^2) \log(x^2 + y^2)^{1/2}$ ,  $\mathbf{X}_0 = (0, 0)$

(e)  $f(\mathbf{X}) = \frac{\sin(x - y)}{\sqrt{x - y}}$ ,  $\mathbf{X}_0 = (2, 2)$

(f)  $f(\mathbf{X}) = \frac{1}{|\mathbf{X}|} e^{-1/|\mathbf{X}|}$ ,  $\mathbf{X}_0 = \mathbf{0}$

2. Prove Theorem 5.2.2.

3. If  $\lim_{x \rightarrow x_0} y(x) = y_0$  and  $\lim_{x \rightarrow x_0} f(x, y(x)) = L$ , we say that  $f(x, y)$  approaches  $L$  as  $(x, y)$  approaches  $(x_0, y_0)$  along the curve  $y = y(x)$ .

(a) Prove: If  $\lim_{(x,y) \rightarrow (x_0,y_0)} f(x, y) = L$ , then  $f(x, y)$  approaches  $L$  as  $(x, y)$  approaches  $(x_0, y_0)$  along any curve  $y = y(x)$  through  $(x_0, y_0)$ .

(b) We saw in Example 5.2.3 that if

$$f(x, y) = \frac{xy}{x^2 + y^2},$$

then  $\lim_{(x,y) \rightarrow (0,0)} f(x, y)$  does not exist. Show, however, that  $f(x, y)$  approaches a value  $L_a$  as  $(x, y)$  approaches  $(0, 0)$  along any curve  $y = y(x)$  that passes through  $(0, 0)$  with slope  $a$ . Find  $L_a$ .

(c) Show that the function

$$g(x, y) = \frac{x^3 y^4}{(x^2 + y^6)^3}$$

approaches 0 as  $(x, y)$  approaches  $(0, 0)$  along a curve as described in (b), but that  $\lim_{(x,y) \rightarrow (0,0)} f(x, y)$  does not exist.

4. Determine whether  $\lim_{\mathbf{X} \rightarrow \mathbf{X}_0} f(\mathbf{X}) = \pm\infty$ .

(a)  $f(\mathbf{X}) = \frac{|\sin(x + 2y + 4z)|}{(x + 2y + 4z)^2}$ ,  $\mathbf{X}_0 = (2, -1, 0)$

(b)  $f(\mathbf{X}) = \frac{1}{\sqrt{x - y}}$ ,  $\mathbf{X}_0 = (0, 0)$

(c)  $f(\mathbf{X}) = \frac{\sin 1/x}{\sqrt{x - y}}$ ,  $\mathbf{X}_0 = (0, 0)$

(d)  $f(\mathbf{X}) = \frac{4y^2 - x^2}{(x - 2y)^3}$ ,  $\mathbf{X}_0 = (2, 1)$

(e)  $f(\mathbf{X}) = \frac{\sin(x + 2y + 4z)}{(x + 2y + 4z)^2}$ ,  $\mathbf{X}_0 = (2, -1, 0)$

5. Find  $\lim_{|\mathbf{X}| \rightarrow \infty} f(\mathbf{X})$ , if it exists.

(a)  $f(\mathbf{X}) = \frac{\log(x^2 + 2y^2 + 4z^2)}{x^2 + y^2 + z^2}$       (b)  $f(\mathbf{X}) = \frac{\sin(x^2 + y^2)}{\sqrt{x^2 + y^2}}$

(c)  $f(\mathbf{X}) = e^{-(x+y)^2}$       (d)  $f(\mathbf{X}) = e^{-x^2 - y^2}$

$$(e) f(\mathbf{X}) = \begin{cases} \frac{\sin(x^2 - y^2)}{x^2 - y^2}, & x \neq \pm y, \\ 1, & x = \pm y \end{cases}$$

6. Define (a)  $\lim_{|\mathbf{X}| \rightarrow \infty} f(\mathbf{X}) = \infty$  and (b)  $\lim_{|\mathbf{X}| \rightarrow \infty} f(\mathbf{X}) = -\infty$ .

7. Let

$$f(\mathbf{X}) = \frac{|x_1|^{a_1} |x_2|^{a_2} \cdots |x_n|^{a_n}}{|\mathbf{X}|^b}.$$

For what nonnegative values of  $a_1, a_2, \dots, a_n, b$  does  $\lim_{\mathbf{X} \rightarrow \mathbf{0}} f(\mathbf{X})$  exist in the extended reals?

8. Let

$$g(\mathbf{X}) = \frac{(x^2 + y^4)^3}{1 + x^6 y^4}.$$

Show that  $\lim_{|x| \rightarrow \infty} g(x, ax) = \infty$  for any real number  $a$ . Does

$$\lim_{|\mathbf{X}| \rightarrow \infty} g(\mathbf{X}) = \infty?$$

9. For each  $f$  in Exercise 5.2.1, find the largest set  $S$  on which  $f$  is continuous or can be defined so as to be continuous.
10. Repeat Exercise 5.2.9 for the functions in Exercise 5.2.5.
11. Give an example of a function  $f$  on  $\mathbb{R}^2$  such that  $f$  is not continuous at  $(0, 0)$ , but  $f(0, y)$  is a continuous function of  $y$  on  $(-\infty, \infty)$  and  $f(x, 0)$  is a continuous function of  $x$  on  $(-\infty, \infty)$ .
12. Prove Theorem 5.2.11. HINT: See the proof of Theorem 2.2.8.
13. Prove Theorem 5.2.12. HINT: See the proof of Theorem 2.2.9.
14. Prove Theorem 5.2.14. HINT: See the proof of Theorem 2.2.12.
15. Suppose that  $\bar{\mathbf{X}} \in D_f \subset \mathbb{R}^n$  and  $\bar{\mathbf{X}}$  is a limit point of  $D_f$ . Show that  $f$  is continuous at  $\bar{\mathbf{X}}$  if and only if  $\lim_{k \rightarrow \infty} f(\mathbf{X}_k) = f(\bar{\mathbf{X}})$  whenever  $\{\mathbf{X}_k\}$  is a sequence of points in  $D_f$  such that  $\lim_{k \rightarrow \infty} \mathbf{X}_k = \bar{\mathbf{X}}$ . HINT: See the proof of Theorem 4.2.6.

### 5.3 PARTIAL DERIVATIVES AND THE DIFFERENTIAL

To say that a function of one variable has a derivative at  $x_0$  is the same as to say that it is differentiable at  $x_0$ . The situation is not so simple for a function  $f$  of more than one variable. First, there is no specific number that can be called *the* derivative of  $f$  at a point  $\mathbf{X}_0$  in  $\mathbb{R}^n$ . In fact, there are infinitely many numbers, called the *directional derivatives of  $f$  at  $\mathbf{X}_0$*  (defined below), that are analogous to the derivative of a function of one variable. Second, we will see that the existence of directional derivatives at  $\mathbf{X}_0$  does not imply that  $f$  is differentiable at  $\mathbf{X}_0$ , if differentiability at  $\mathbf{X}_0$  is to imply (as it does for functions of one variable) that  $f(\mathbf{X}) - f(\mathbf{X}_0)$  can be approximated well near  $\mathbf{X}_0$  by a simple linear function, or even that  $f$  is continuous at  $\mathbf{X}_0$ .

We will now define directional derivatives and partial derivatives of functions of several variables. However, we will still have occasion to refer to derivatives of functions of one variable. We will call them *ordinary* derivatives when we wish to distinguish between them and the partial derivatives that we are about to define.

**Definition 5.3.1** Let  $\Phi$  be a unit vector and  $\mathbf{X}$  a point in  $\mathbb{R}^n$ . The *directional derivative of  $f$  at  $\mathbf{X}$  in the direction of  $\Phi$*  is defined by

$$\frac{\partial f(\mathbf{X})}{\partial \Phi} = \lim_{t \rightarrow 0} \frac{f(\mathbf{X} + t\Phi) - f(\mathbf{X})}{t}$$

if the limit exists. That is,  $\partial f(\mathbf{X})/\partial \Phi$  is the ordinary derivative of the function

$$h(t) = f(\mathbf{X} + t\Phi)$$

at  $t = 0$ , if  $h'(0)$  exists.

**Example 5.3.1** Let  $\Phi = (\phi_1, \phi_2, \phi_3)$  and

$$f(x, y, z) = 3xyz + 2x^2 + z^2.$$

Then

$$\begin{aligned} h(t) &= f(x + t\phi_1, y + t\phi_2, z + t\phi_3), \\ &= 3(x + t\phi_1)(y + t\phi_2)(z + t\phi_3) + 2(x + t\phi_1)^2 + (z + t\phi_3)^2 \end{aligned}$$

and

$$\begin{aligned} h'(t) &= 3\phi_1(y + t\phi_2)(z + t\phi_3) + 3\phi_2(x + t\phi_1)(z + t\phi_3) \\ &\quad + 3\phi_3(x + t\phi_1)(y + t\phi_2) + 4\phi_1(x + t\phi_1) + 2\phi_3(z + t\phi_3). \end{aligned}$$

Therefore,

$$\frac{\partial f(\mathbf{X})}{\partial \Phi} = h'(0) = (3yz + 4x)\phi_1 + 3xz\phi_2 + (3xy + 2z)\phi_3. \quad (5.3.1)$$

■

The directional derivatives that we are most interested in are those in the directions of the unit vectors

$$\mathbf{E}_1 = (1, 0, \dots, 0), \quad \mathbf{E}_2 = (0, 1, 0, \dots, 0), \dots, \quad \mathbf{E}_n = (0, \dots, 0, 1).$$

(All components of  $\mathbf{E}_i$  are zero except for the  $i$ th, which is 1.) Since  $\mathbf{X}$  and  $\mathbf{X} + t\mathbf{E}_i$  differ only in the  $i$ th coordinate,  $\partial f(\mathbf{X})/\partial \mathbf{E}_i$  is called the *partial derivative of  $f$  with respect to  $x_i$  at  $\mathbf{X}$* . It is also denoted by  $\partial f(\mathbf{X})/\partial x_i$  or  $f_{x_i}(\mathbf{X})$ ; thus,

$$\frac{\partial f(\mathbf{X})}{\partial x_1} = f_{x_1}(\mathbf{X}) = \lim_{t \rightarrow 0} \frac{f(x_1 + t, x_2, \dots, x_n) - f(x_1, x_2, \dots, x_n)}{t},$$

$$\frac{\partial f(\mathbf{X})}{\partial x_i} = f_{x_i}(\mathbf{X}) = \lim_{t \rightarrow 0} \frac{f(x_1, \dots, x_{i-1}, x_i + t, x_{i+1}, \dots, x_n) - f(x_1, x_2, \dots, x_n)}{t}$$

if  $2 \leq i \leq n$ , and

$$\frac{\partial f(\mathbf{X})}{\partial x_n} = f_{x_n}(\mathbf{X}) = \lim_{t \rightarrow 0} \frac{f(x_1, \dots, x_{n-1}, x_n + t) - f(x_1, \dots, x_{n-1}, x_n)}{t},$$

if the limits exist.

If we write  $\mathbf{X} = (x, y)$ , then we denote the partial derivatives accordingly; thus,

$$\frac{\partial f(x, y)}{\partial x} = f_x(x, y) = \lim_{h \rightarrow 0} \frac{f(x + h, y) - f(x, y)}{h}$$

and

$$\frac{\partial f(x, y)}{\partial y} = f_y(x, y) = \lim_{h \rightarrow 0} \frac{f(x, y + h) - f(x, y)}{h}.$$

It can be seen from these definitions that to compute  $f_{x_i}(\mathbf{X})$  we simply differentiate  $f$  with respect to  $x_i$  according to the rules for ordinary differentiation, while treating the other variables as constants.

**Example 5.3.2** Let

$$f(x, y, z) = 3xyz + 2x^2 + z^2 \quad (5.3.2)$$

as in Example 5.3.1. Taking  $\Phi = \mathbf{E}_1$  (that is, setting  $\phi_1 = 1$  and  $\phi_2 = \phi_3 = 0$ ) in (5.3.1), we find that

$$\frac{\partial f(\mathbf{X})}{\partial x} = \frac{\partial f(\mathbf{X})}{\partial \mathbf{E}_1} = 3yz + 4x,$$

which is the result obtained by regarding  $y$  and  $z$  as constants in (5.3.2) and taking the ordinary derivative with respect to  $x$ . Similarly,

$$\frac{\partial f(\mathbf{X})}{\partial y} = \frac{\partial f(\mathbf{X})}{\partial \mathbf{E}_2} = 3xz$$

and

$$\frac{\partial f(\mathbf{X})}{\partial z} = \frac{\partial f(\mathbf{X})}{\partial \mathbf{E}_3} = 3xy + 2z. \quad \blacksquare$$

The next theorem follows from the rule just given for calculating partial derivatives.

**Theorem 5.3.2** If  $f_{x_i}(\mathbf{X})$  and  $g_{x_i}(\mathbf{X})$  exist, then

$$\begin{aligned} \frac{\partial(f + g)(\mathbf{X})}{\partial x_i} &= f_{x_i}(\mathbf{X}) + g_{x_i}(\mathbf{X}), \\ \frac{\partial(fg)(\mathbf{X})}{\partial x_i} &= f_{x_i}(\mathbf{X})g(\mathbf{X}) + f(\mathbf{X})g_{x_i}(\mathbf{X}), \end{aligned}$$

and, if  $g(\mathbf{X}) \neq 0$ ,

$$\frac{\partial(f/g)(\mathbf{X})}{\partial x_i} = \frac{g(\mathbf{X})f_{x_i}(\mathbf{X}) - f(\mathbf{X})g_{x_i}(\mathbf{X})}{[g(\mathbf{X})]^2}.$$

If  $f_{x_i}(\mathbf{X})$  exists at every point of a set  $D$ , then it defines a function  $f_{x_i}$  on  $D$ . If this function has a partial derivative with respect to  $x_j$  on a subset of  $D$ , we denote the partial derivative by

$$\frac{\partial}{\partial x_j} \left( \frac{\partial f}{\partial x_i} \right) = \frac{\partial^2 f}{\partial x_j \partial x_i} = f_{x_i x_j}.$$

Similarly,

$$\frac{\partial}{\partial x_k} \left( \frac{\partial^2 f}{\partial x_j \partial x_i} \right) = \frac{\partial^3 f}{\partial x_k \partial x_j \partial x_i} = f_{x_i x_j x_k}.$$

The function obtained by differentiating  $f$  successively with respect to  $x_{i_1}, x_{i_2}, \dots, x_{i_r}$  is denoted by

$$\frac{\partial^r f}{\partial x_{i_r} \partial x_{i_{r-1}} \cdots \partial x_{i_1}} = f_{x_{i_1} \cdots x_{i_{r-1}} x_{i_r}};$$

it is an  $r$ th-order partial derivative of  $f$ .

**Example 5.3.3** The function

$$f(x, y) = 3x^2y^3 + xy$$

has partial derivatives everywhere. Its first-order partial derivatives are

$$f_x(x, y) = 6xy^3 + y, \quad f_y(x, y) = 9x^2y^2 + x.$$

Its second-order partial derivatives are

$$\begin{aligned} f_{xx}(x, y) &= 6y^3, & f_{yy}(x, y) &= 18x^2y, \\ f_{xy}(x, y) &= 18xy^2 + 1, & f_{yx}(x, y) &= 18xy^2 + 1. \end{aligned}$$

There are eight third-order partial derivatives. Some examples are

$$f_{xxy}(x, y) = 18y^2, \quad f_{xyx}(x, y) = 18y^2, \quad f_{yxx}(x, y) = 18y^2.$$

**Example 5.3.4** Compute  $f_{xx}(0, 0)$ ,  $f_{yy}(0, 0)$ ,  $f_{xy}(0, 0)$ , and  $f_{yx}(0, 0)$  if

$$f(x, y) = \begin{cases} \frac{(x^2y + xy^2) \sin(x - y)}{x^2 + y^2}, & (x, y) \neq (0, 0), \\ 0, & (x, y) = (0, 0). \end{cases}$$

**Solution** If  $(x, y) \neq (0, 0)$ , the ordinary rules for differentiation, applied separately to  $x$  and  $y$ , yield

$$\begin{aligned} f_x(x, y) &= \frac{(2xy + y^2) \sin(x - y) + (x^2y + xy^2) \cos(x - y)}{x^2 + y^2} \\ &\quad - \frac{2x(x^2y + xy^2) \sin(x - y)}{(x^2 + y^2)^2}, \quad (x, y) \neq (0, 0), \end{aligned} \tag{5.3.3}$$



and

$$f_y(x, y) = \frac{(x^2 + 2xy) \sin(x - y) - (x^2y + xy^2) \cos(x - y)}{x^2 + y^2} - \frac{2y(x^2y + xy^2) \sin(x - y)}{(x^2 + y^2)^2}, \quad (x, y) \neq (0, 0). \quad (5.3.4)$$

These formulas do not apply if  $(x, y) = (0, 0)$ , so we find  $f_x(0, 0)$  and  $f_y(0, 0)$  from their definitions as difference quotients:

$$f_x(0, 0) = \lim_{x \rightarrow 0} \frac{f(x, 0) - f(0, 0)}{x} = \lim_{x \rightarrow 0} \frac{0 - 0}{x} = 0,$$

$$f_y(0, 0) = \lim_{y \rightarrow 0} \frac{f(0, y) - f(0, 0)}{y} = \lim_{y \rightarrow 0} \frac{0 - 0}{y} = 0.$$

Setting  $y = 0$  in (5.3.3) and (5.3.4) yields

$$f_x(x, 0) = 0, \quad f_y(x, 0) = \sin x, \quad x \neq 0,$$

so

$$f_{xx}(0, 0) = \lim_{x \rightarrow 0} \frac{f_x(x, 0) - f_x(0, 0)}{x} = \lim_{x \rightarrow 0} \frac{0 - 0}{x} = 0,$$

$$f_{yx}(0, 0) = \lim_{x \rightarrow 0} \frac{f_y(x, 0) - f_y(0, 0)}{x} = \lim_{x \rightarrow 0} \frac{\sin x - 0}{x} = 1.$$

Setting  $x = 0$  in (5.3.3) and (5.3.4) yields

$$f_x(0, y) = -\sin y, \quad f_y(0, y) = 0, \quad y \neq 0,$$

so

$$f_{xy}(0, 0) = \lim_{y \rightarrow 0} \frac{f_x(0, y) - f_x(0, 0)}{y} = \lim_{y \rightarrow 0} \frac{-\sin y - 0}{y} = -1,$$

$$f_{yy}(0, 0) = \lim_{y \rightarrow 0} \frac{f_y(0, y) - f_y(0, 0)}{y} = \lim_{y \rightarrow 0} \frac{0 - 0}{y} = 0. \quad \blacksquare$$

This example shows that  $f_{xy}(\mathbf{X}_0)$  and  $f_{yx}(\mathbf{X}_0)$  may differ. However, the next theorem shows that they are equal if  $f$  satisfies a fairly mild condition.

**Theorem 5.3.3** *Suppose that  $f$ ,  $f_x$ ,  $f_y$ , and  $f_{xy}$  exist on a neighborhood  $N$  of  $(x_0, y_0)$ , and  $f_{xy}$  is continuous at  $(x_0, y_0)$ . Then  $f_{yx}(x_0, y_0)$  exists, and*

$$f_{yx}(x_0, y_0) = f_{xy}(x_0, y_0). \quad (5.3.5)$$

**Proof** Suppose that  $\epsilon > 0$ . Choose  $\delta > 0$  so that the open square

$$S_\delta = \{(x, y) \mid |x - x_0| < \delta, |y - y_0| < \delta\}$$

is in  $N$  and

$$|f_{xy}(\widehat{x}, \widehat{y}) - f_{xy}(x_0, y_0)| < \epsilon \quad \text{if } (\widehat{x}, \widehat{y}) \in S_\delta. \quad (5.3.6)$$

This is possible because of the continuity of  $f_{xy}$  at  $(x_0, y_0)$ . The function

$$A(h, k) = f(x_0 + h, y_0 + k) - f(x_0 + h, y_0) - f(x_0, y_0 + k) + f(x_0, y_0) \quad (5.3.7)$$

is defined if  $-\delta < h, k < \delta$ ; moreover,

$$A(h, k) = \phi(x_0 + h) - \phi(x_0), \quad (5.3.8)$$

where

$$\phi(x) = f(x, y_0 + k) - f(x, y_0).$$

Since

$$\phi'(x) = f_x(x, y_0 + k) - f_x(x, y_0), \quad |x - x_0| < \delta,$$

(5.3.8) and the mean value theorem imply that

$$A(h, k) = [f_x(\widehat{x}, y_0 + k) - f_x(\widehat{x}, y_0)]h, \quad (5.3.9)$$

where  $\widehat{x}$  is between  $x_0$  and  $x_0 + h$ . The mean value theorem, applied to  $f_x(\widehat{x}, y)$  (where  $\widehat{x}$  is regarded as constant), also implies that

$$f_x(\widehat{x}, y_0 + k) - f_x(\widehat{x}, y_0) = f_{xy}(\widehat{x}, \widehat{y})k,$$

where  $\widehat{y}$  is between  $y_0$  and  $y_0 + k$ . From this and (5.3.9),

$$A(h, k) = f_{xy}(\widehat{x}, \widehat{y})hk.$$

Now (5.3.6) implies that

$$\left| \frac{A(h, k)}{hk} - f_{xy}(x_0, y_0) \right| = |f_{xy}(\widehat{x}, \widehat{y}) - f_{xy}(x_0, y_0)| < \epsilon \quad \text{if } 0 < |h|, |k| < \delta. \quad (5.3.10)$$

Since (5.3.7) implies that

$$\begin{aligned} \lim_{k \rightarrow 0} \frac{A(h, k)}{hk} &= \lim_{k \rightarrow 0} \frac{f(x_0 + h, y_0 + k) - f(x_0 + h, y_0)}{hk} \\ &\quad - \lim_{k \rightarrow 0} \frac{f(x_0, y_0 + k) - f(x_0, y_0)}{hk} \\ &= \frac{f_y(x_0 + h, y_0) - f_y(x_0, y_0)}{h}, \end{aligned}$$

it follows from (5.3.10) that

$$\left| \frac{f_y(x_0 + h, y_0) - f_y(x_0, y_0)}{h} - f_{xy}(x_0, y_0) \right| \leq \epsilon \quad \text{if } 0 < |h| < \delta.$$

Taking the limit as  $h \rightarrow 0$  yields

$$|f_{yx}(x_0, y_0) - f_{xy}(x_0, y_0)| \leq \epsilon.$$

Since  $\epsilon$  is an arbitrary positive number, this proves (5.3.5).  $\blacksquare$

Theorem 5.3.3 implies the following theorem. We leave the proof to you (Exercises 5.3.10 and 5.3.11).

**Theorem 5.3.4** *Suppose that  $f$  and all its partial derivatives of order  $\leq r$  are continuous on an open subset  $S$  of  $\mathbb{R}^n$ . Then*

$$f_{x_{i_1} x_{i_2} \dots x_{i_r}}(\mathbf{X}) = f_{x_{j_1} x_{j_2} \dots x_{j_r}}(\mathbf{X}), \quad \mathbf{X} \in S, \quad (5.3.11)$$

if each of the variables  $x_1, x_2, \dots, x_n$  appears the same number of times in

$$\{x_{i_1}, x_{i_2}, \dots, x_{i_r}\} \quad \text{and} \quad \{x_{j_1}, x_{j_2}, \dots, x_{j_r}\}.$$

If this number is  $r_k$ , we denote the common value of the two sides of (5.3.11) by

$$\frac{\partial^r f(\mathbf{X})}{\partial x_1^{r_1} \partial x_2^{r_2} \dots \partial x_n^{r_n}}, \quad (5.3.12)$$

it being understood that

$$0 \leq r_k \leq r, \quad 1 \leq k \leq n, \quad (5.3.13)$$

$$r_1 + r_2 + \dots + r_n = r, \quad (5.3.14)$$

and, if  $r_k = 0$ , we omit the symbol  $\partial x_k^0$  from the “denominator” of (5.3.12).

For example, if  $f$  satisfies the hypotheses of Theorem 5.3.4 with  $k = 4$  at a point  $\mathbf{X}_0$  in  $\mathbb{R}^n$  ( $n \geq 2$ ), then

$$f_{xxyy}(\mathbf{X}_0) = f_{xyxy}(\mathbf{X}_0) = f_{xyyx}(\mathbf{X}_0) = f_{yyxx}(\mathbf{X}_0) = f_{yxyx}(\mathbf{X}_0) = f_{yxxy}(\mathbf{X}_0),$$

and their common value is denoted by

$$\frac{\partial^4 f(\mathbf{X}_0)}{\partial x^2 \partial y^2}.$$

It can be shown (Exercise 5.3.12) that if  $f$  is a function of  $(x_1, x_2, \dots, x_n)$  and  $(r_1, r_2, \dots, r_n)$  is a fixed ordered  $n$ -tuple that satisfies (5.3.13) and (5.3.14), then the number of partial derivatives  $f_{x_{i_1} x_{i_2} \dots x_{i_r}}$  that involve differentiation  $r_i$  times with respect to  $x_i$ ,  $1 \leq i \leq n$ , equals the *multinomial coefficient*

$$\frac{r!}{r_1! r_2! \dots r_n!}.$$

### Differentiable Functions of Several Variables

A function of several variables may have first-order partial derivatives at a point  $\mathbf{X}_0$  but fail to be continuous at  $\mathbf{X}_0$ . For example, if

$$f(x, y) = \begin{cases} \frac{xy}{x^2 + y^2}, & (x, y) \neq (0, 0), \\ 0, & (x, y) = (0, 0), \end{cases} \quad (5.3.15)$$

then

$$f_x(0, 0) = \lim_{h \rightarrow 0} \frac{f(h, 0) - f(0, 0)}{h} = \lim_{h \rightarrow 0} \frac{0 - 0}{h} = 0$$

and

$$f_y(0, 0) = \lim_{k \rightarrow 0} \frac{f(0, k) - f(0, 0)}{k} = \lim_{k \rightarrow 0} \frac{0 - 0}{k} = 0,$$

but  $f$  is not continuous at  $(0, 0)$ . (See Examples 5.2.3 and 5.2.11.) Therefore, if differentiability of a function of several variables is to be a stronger property than continuity, as it is for functions of one variable, the definition of differentiability must require more than the existence of first partial derivatives. Exercise 2.3.1 characterizes differentiability of a function  $f$  of one variable in a way that suggests the proper generalization:  $f$  is differentiable at  $x_0$  if and only if

$$\lim_{x \rightarrow x_0} \frac{f(x) - f(x_0) - m(x - x_0)}{x - x_0} = 0$$

for some constant  $m$ , in which case  $m = f'(x_0)$ .

The generalization to functions of  $n$  variables is as follows.

**Definition 5.3.5** A function  $f$  is *differentiable* at

$$\mathbf{X}_0 = (x_{10}, x_{20}, \dots, x_{n0})$$

if  $\mathbf{X}_0 \in D_f^0$  and there are constants  $m_1, m_2, \dots, m_n$  such that

$$\lim_{\mathbf{X} \rightarrow \mathbf{X}_0} \frac{f(\mathbf{X}) - f(\mathbf{X}_0) - \sum_{i=1}^n m_i(x_i - x_{i0})}{|\mathbf{X} - \mathbf{X}_0|} = 0. \quad (5.3.16)$$

**Example 5.3.5** Let

$$f(x, y) = x^2 + 2xy.$$

We will show that  $f$  is differentiable at any point  $(x_0, y_0)$ , as follows:

$$\begin{aligned}
f(x, y) - f(x_0, y_0) &= x^2 + 2xy - x_0^2 - 2x_0y_0 \\
&= x^2 - x_0^2 + 2(xy - x_0y_0) \\
&= (x - x_0)(x + x_0) + 2(xy - x_0y) + 2(x_0y - x_0y_0) \\
&= (x + x_0 + 2y)(x - x_0) + 2x_0(y - y_0) \\
&= 2(x_0 + y_0)(x - x_0) + 2x_0(y - y_0) \\
&\quad + (x - x_0)(x - x_0 + 2y - 2y_0) \\
&= m_1(x - x_0) + m_2(y - y_0) + (x - x_0)(x - x_0 + 2y - 2y_0),
\end{aligned}$$

where

$$m_1 = 2(x_0 + y_0) = f_x(x_0, y_0) \quad \text{and} \quad m_2 = 2x_0 = f_y(x_0, y_0). \quad (5.3.17)$$

Therefore,

$$\begin{aligned}
\frac{|f(x, y) - f(x_0, y_0) - m_1(x - x_0) - m_2(y - y_0)|}{|\mathbf{X} - \mathbf{X}_0|} &= \frac{|x - x_0|(x - x_0 + 2(y - y_0))|}{|\mathbf{X} - \mathbf{X}_0|} \\
&\leq \sqrt{5}|\mathbf{X} - \mathbf{X}_0|,
\end{aligned}$$

by Schwarz's inequality. This implies that

$$\lim_{\mathbf{X} \rightarrow \mathbf{X}_0} \frac{f(x, y) - f(x_0, y_0) - m_1(x - x_0) - m_2(y - y_0)}{|\mathbf{X} - \mathbf{X}_0|} = 0,$$

so  $f$  is differentiable at  $(x_0, y_0)$ . ■

From (5.3.17),  $m_1 = f_x(x_0, y_0)$  and  $m_2 = f_y(x_0, y_0)$  in Example 5.3.5. The next theorem shows that this is not a coincidence.

**Theorem 5.3.6** *If  $f$  is differentiable at  $\mathbf{X}_0 = (x_{10}, x_{20}, \dots, x_{n0})$ , then  $f_{x_1}(\mathbf{X}_0)$ ,  $f_{x_2}(\mathbf{X}_0), \dots, f_{x_n}(\mathbf{X}_0)$  exist and the constants  $m_1, m_2, \dots, m_n$  in (5.3.16) are given by*

$$m_i = f_{x_i}(\mathbf{X}_0), \quad 1 \leq i \leq n; \quad (5.3.18)$$

that is,

$$\lim_{\mathbf{X} \rightarrow \mathbf{X}_0} \frac{f(\mathbf{X}) - f(\mathbf{X}_0) - \sum_{i=1}^n f_{x_i}(\mathbf{X}_0)(x_i - x_{i0})}{|\mathbf{X} - \mathbf{X}_0|} = 0.$$

**Proof** Let  $i$  be a given integer in  $\{1, 2, \dots, n\}$ . Let  $\mathbf{X} = \mathbf{X}_0 + t\mathbf{E}_i$ , so that  $x_i = x_{i0} + t$ ,  $x_j = x_{j0}$  if  $j \neq i$ , and  $|\mathbf{X} - \mathbf{X}_0| = |t|$ . Then (5.3.16) and the differentiability of  $f$  at  $\mathbf{X}_0$  imply that

$$\lim_{t \rightarrow 0} \frac{f(\mathbf{X}_0 + t\mathbf{E}_i) - f(\mathbf{X}_0) - m_i t}{t} = 0.$$

Hence,

$$\lim_{t \rightarrow 0} \frac{f(\mathbf{X}_0 + t\mathbf{E}_i) - f(\mathbf{X}_0)}{t} = m_i.$$

This proves (5.3.18), since the limit on the left is  $f_{x_i}(\mathbf{X}_0)$ , by definition. ■

A *linear function* is a function of the form

$$L(\mathbf{X}) = m_1x_1 + m_2x_2 + \cdots + m_nx_n, \quad (5.3.19)$$

where  $m_1, m_2, \dots, m_n$  are constants. From Definition 5.3.5,  $f$  is differentiable at  $\mathbf{X}_0$  if and only if there is a linear function  $L$  such that  $f(\mathbf{X}) - f(\mathbf{X}_0)$  can be approximated so well near  $\mathbf{X}_0$  by

$$L(\mathbf{X}) - L(\mathbf{X}_0) = L(\mathbf{X} - \mathbf{X}_0)$$

that

$$f(\mathbf{X}) - f(\mathbf{X}_0) = L(\mathbf{X} - \mathbf{X}_0) + E(\mathbf{X})(|\mathbf{X} - \mathbf{X}_0|), \quad (5.3.20)$$

where

$$\lim_{\mathbf{X} \rightarrow \mathbf{X}_0} E(\mathbf{X}) = 0. \quad (5.3.21)$$

**Theorem 5.3.7** *If  $f$  is differentiable at  $\mathbf{X}_0$ , then  $f$  is continuous at  $\mathbf{X}_0$ .*

**Proof** From (5.3.19) and Schwarz's inequality,

$$|L(\mathbf{X} - \mathbf{X}_0)| \leq M|\mathbf{X} - \mathbf{X}_0|,$$

where

$$M = (m_1^2 + m_2^2 + \cdots + m_n^2)^{1/2}.$$

This and (5.3.20) imply that

$$|f(\mathbf{X}) - f(\mathbf{X}_0)| \leq (M + |E(\mathbf{X})|)|\mathbf{X} - \mathbf{X}_0|,$$

which, with (5.3.21), implies that  $f$  is continuous at  $\mathbf{X}_0$ . ■

Theorem 5.3.7 implies that the function  $f$  defined by (5.3.15) is not differentiable at  $(0, 0)$ , since it is not continuous at  $(0, 0)$ . However,  $f_x(0, 0)$  and  $f_y(0, 0)$  exist, so the converse of Theorem 5.3.7 is false; that is, a function may have partial derivatives at a point without being differentiable at the point.

## The Differential

Theorem 5.3.7 implies that if  $f$  is differentiable at  $\mathbf{X}_0$ , then there is exactly one linear function  $L$  that satisfies (5.3.20) and (5.3.21):

$$L(\mathbf{X}) = f_{x_1}(\mathbf{X}_0)x_1 + f_{x_2}(\mathbf{X}_0)x_2 + \cdots + f_{x_n}(\mathbf{X}_0)x_n.$$

This function is called the *differential of  $f$  at  $\mathbf{X}_0$* . We will denote it by  $d_{\mathbf{X}_0}f$  and its value by  $(d_{\mathbf{X}_0}f)(\mathbf{X})$ ; thus,

$$(d_{\mathbf{X}_0}f)(\mathbf{X}) = f_{x_1}(\mathbf{X}_0)x_1 + f_{x_2}(\mathbf{X}_0)x_2 + \cdots + f_{x_n}(\mathbf{X}_0)x_n. \quad (5.3.22)$$

In terms of the differential, (5.3.16) can be rewritten as

$$\lim_{\mathbf{X} \rightarrow \mathbf{X}_0} \frac{f(\mathbf{X}) - f(\mathbf{X}_0) - (d_{\mathbf{X}_0}f)(\mathbf{X} - \mathbf{X}_0)}{|\mathbf{X} - \mathbf{X}_0|} = 0.$$

For convenience in writing  $d_{\mathbf{X}_0}f$ , and to conform with standard notation, we introduce the function  $dx_i$ , defined by

$$dx_i(\mathbf{X}) = x_i;$$

that is,  $dx_i$  is the function whose value at a point in  $\mathbb{R}^n$  is the  $i$ th coordinate of the point. It is the differential of the function  $g_i(\mathbf{X}) = x_i$ . From (5.3.22),

$$d_{\mathbf{X}_0}f = f_{x_1}(\mathbf{X}_0)dx_1 + f_{x_2}(\mathbf{X}_0)dx_2 + \cdots + f_{x_n}(\mathbf{X}_0)dx_n. \quad (5.3.23)$$

If we write  $\mathbf{X} = (x, y, \dots)$ , then we write

$$d_{\mathbf{X}_0}f = f_x(\mathbf{X}_0)dx + f_y(\mathbf{X}_0)dy + \cdots,$$

where  $dx, dy, \dots$  are the functions defined by

$$dx(\mathbf{X}) = x, \quad dy(\mathbf{X}) = y, \dots$$

When it is not necessary to emphasize the specific point  $\mathbf{X}_0$ , (5.3.23) can be written more simply as

$$df = f_{x_1}dx_1 + f_{x_2}dx_2 + \cdots + f_{x_n}dx_n.$$

When dealing with a specific function at an arbitrary point of its domain, we may use the hybrid notation

$$df = f_{x_1}(\mathbf{X})dx_1 + f_{x_2}(\mathbf{X})dx_2 + \cdots + f_{x_n}(\mathbf{X})dx_n.$$

**Example 5.3.6** We saw in Example 5.3.5 that the function

$$f(x, y) = x^2 + 2xy$$

is differentiable at every  $\mathbf{X}$  in  $\mathbb{R}^n$ , with differential

$$df = (2x + 2y)dx + 2x dy.$$

To find  $d_{\mathbf{X}_0}f$  with  $\mathbf{X}_0 = (1, 2)$ , we set  $x_0 = 1$  and  $y_0 = 2$ ; thus,

$$d_{\mathbf{X}_0}f = 6dx + 2dy$$

and

$$(d_{\mathbf{X}_0}f)(\mathbf{X} - \mathbf{X}_0) = 6(x - 1) + 2(y - 2).$$

Since  $f(1, 2) = 5$ , the differentiability of  $f$  at  $(1, 2)$  implies that

$$\lim_{(x,y) \rightarrow (1,2)} \frac{f(x, y) - 5 - 6(x - 1) - 2(y - 2)}{\sqrt{(x - 1)^2 + (y - 2)^2}} = 0.$$

**Example 5.3.7** The differential of a function  $f = f(x)$  of one variable is given by

$$d_{x_0} f = f'(x_0) dx,$$

where  $dx$  is the identity function; that is,

$$dx(t) = t.$$

For example, if

$$f(x) = 3x^2 + 5x^3,$$

then

$$df = (6x + 15x^2) dx.$$

If  $x_0 = -1$ , then

$$d_{x_0} f = 9 dx, \quad (d_{x_0} f)(x - x_0) = 9(x + 1),$$

and, since  $f(-1) = -2$ ,

$$\lim_{x \rightarrow -1} \frac{f(x) + 2 - 9(x + 1)}{x + 1} = 0. \quad \blacksquare$$

Unfortunately, the notation for the differential is so complicated that it obscures the simplicity of the concept. The peculiar symbols  $df$ ,  $dx$ ,  $dy$ , etc., were introduced in the early stages of the development of calculus to represent very small (“infinitesimal”) increments in the variables. However, in modern usage they are not quantities at all, but linear functions. This meaning of the symbol  $dx$  differs from its meaning in  $\int_a^b f(x) dx$ , where it serves merely to identify the variable of integration; indeed, some authors omit it in the latter context and write simply  $\int_a^b f$ .

Theorem 5.3.7 implies the following lemma, which is analogous to Lemma 2.3.2. We leave the proof to you (Exercise 5.3.13).

**Lemma 5.3.8** *If  $f$  is differentiable at  $\mathbf{X}_0$ , then*

$$f(\mathbf{X}) - f(\mathbf{X}_0) = (d_{\mathbf{X}_0} f)(\mathbf{X} - \mathbf{X}_0) + E(\mathbf{X})|\mathbf{X} - \mathbf{X}_0|,$$

where  $E$  is defined in a neighborhood of  $\mathbf{X}_0$  and

$$\lim_{\mathbf{X} \rightarrow \mathbf{X}_0} E(\mathbf{X}) = E(\mathbf{X}_0) = 0.$$

Theorems 5.3.2 and 5.3.7 and the definition of the differential imply the following theorem.



**Theorem 5.3.9** *If  $f$  and  $g$  are differentiable at  $\mathbf{X}_0$ , then so are  $f + g$  and  $fg$ . The same is true of  $f/g$  if  $g(\mathbf{X}_0) \neq 0$ . The differentials are given by*

$$\begin{aligned}d_{\mathbf{X}_0}(f + g) &= d_{\mathbf{X}_0}f + d_{\mathbf{X}_0}g, \\d_{\mathbf{X}_0}(fg) &= f(\mathbf{X}_0)d_{\mathbf{X}_0}g + g(\mathbf{X}_0)d_{\mathbf{X}_0}f,\end{aligned}$$

and

$$d_{\mathbf{X}_0}\left(\frac{f}{g}\right) = \frac{g(\mathbf{X}_0)d_{\mathbf{X}_0}f - f(\mathbf{X}_0)d_{\mathbf{X}_0}g}{[g(\mathbf{X}_0)]^2}.$$

The next theorem provides a widely applicable sufficient condition for differentiability.

**Theorem 5.3.10** *If  $f_{x_1}, f_{x_2}, \dots, f_{x_n}$  exist on a neighborhood of  $\mathbf{X}_0$  and are continuous at  $\mathbf{X}_0$ , then  $f$  is differentiable at  $\mathbf{X}_0$ .*

**Proof** Let  $\mathbf{X}_0 = (x_{10}, x_{20}, \dots, x_{n0})$  and suppose that  $\epsilon > 0$ . Our assumptions imply that there is a  $\delta > 0$  such that  $f_{x_1}, f_{x_2}, \dots, f_{x_n}$  are defined in the  $n$ -ball

$$S_\delta(\mathbf{X}_0) = \{\mathbf{X} \mid |\mathbf{X} - \mathbf{X}_0| < \delta\}$$

and

$$|f_{x_j}(\mathbf{X}) - f_{x_j}(\mathbf{X}_0)| < \epsilon \quad \text{if } |\mathbf{X} - \mathbf{X}_0| < \delta, \quad 1 \leq j \leq n. \quad (5.3.24)$$

Let  $\mathbf{X} = (x_1, x_2, \dots, x_n)$  be in  $S_\delta(\mathbf{X}_0)$ . Define

$$\mathbf{X}_j = (x_1, \dots, x_j, x_{j+1,0}, \dots, x_{n0}), \quad 1 \leq j \leq n-1,$$

and  $\mathbf{X}_n = \mathbf{X}$ . Thus, for  $1 \leq j \leq n$ ,  $\mathbf{X}_j$  differs from  $\mathbf{X}_{j-1}$  in the  $j$ th component only, and the line segment from  $\mathbf{X}_{j-1}$  to  $\mathbf{X}_j$  is in  $S_\delta(\mathbf{X}_0)$ . Now write

$$f(\mathbf{X}) - f(\mathbf{X}_0) = f(\mathbf{X}_n) - f(\mathbf{X}_0) = \sum_{j=1}^n [f(\mathbf{X}_j) - f(\mathbf{X}_{j-1})], \quad (5.3.25)$$

and consider the auxiliary functions

$$\begin{aligned}g_1(t) &= f(t, x_{20}, \dots, x_{n0}), \\g_j(t) &= f(x_1, \dots, x_{j-1}, t, x_{j+1,0}, \dots, x_{n0}), \quad 2 \leq j \leq n-1, \\g_n(t) &= f(x_1, \dots, x_{n-1}, t),\end{aligned} \quad (5.3.26)$$

where, in each case, all variables except  $t$  are temporarily regarded as constants. Since

$$f(\mathbf{X}_j) - f(\mathbf{X}_{j-1}) = g_j(x_j) - g_j(x_{j0}),$$

the mean value theorem implies that

$$f(\mathbf{X}_j) - f(\mathbf{X}_{j-1}) = g'_j(\tau_j)(x_j - x_{j0}),$$

where  $\tau_j$  is between  $x_j$  and  $x_{j0}$ . From (5.3.26),

$$g'_j(\tau_j) = f_{x_j}(\widehat{\mathbf{X}}_j),$$

where  $\widehat{\mathbf{X}}_j$  is on the line segment from  $\mathbf{X}_{j-1}$  to  $\mathbf{X}_j$ . Therefore,

$$f(\mathbf{X}_j) - f(\mathbf{X}_{j-1}) = f_{x_j}(\widehat{\mathbf{X}}_j)(x_j - x_{j0}),$$

and (5.3.25) implies that

$$\begin{aligned} f(\mathbf{X}) - f(\mathbf{X}_0) &= \sum_{j=1}^n f_{x_j}(\widehat{\mathbf{X}}_j)(x_j - x_{j0}) \\ &= \sum_{j=1}^n f_{x_j}(\mathbf{X}_0)(x_j - x_{j0}) + \sum_{j=1}^n [f_{x_j}(\widehat{\mathbf{X}}_j) - f_{x_j}(\mathbf{X}_0)](x_j - x_{j0}). \end{aligned}$$

From this and (5.3.24),

$$\left| f(\mathbf{X}) - f(\mathbf{X}_0) - \sum_{j=1}^n f_{x_j}(\mathbf{X}_0)(x_j - x_{j0}) \right| \leq \epsilon \sum_{j=1}^n |x_j - x_{j0}| \leq n\epsilon |\mathbf{X} - \mathbf{X}_0|,$$

which implies that  $f$  is differentiable at  $\mathbf{X}_0$ .  $\blacksquare$

We say that  $f$  is *continuously differentiable* on a subset  $S$  of  $\mathbb{R}^n$  if  $S$  is contained in an open set on which  $f_{x_1}, f_{x_2}, \dots, f_{x_n}$  are continuous. Theorem 5.3.10 implies that such a function is differentiable at each  $\mathbf{X}_0$  in  $S$ .

**Example 5.3.8** If

$$f(x, y) = \frac{x^2 + y^2}{x - y},$$

then

$$f_x(x, y) = \frac{2x}{x - y} - \frac{x^2 + y^2}{(x - y)^2} \quad \text{and} \quad f_y(x, y) = \frac{2y}{x - y} + \frac{x^2 + y^2}{(x - y)^2}.$$

Since  $f_x$  and  $f_y$  are continuous on

$$S = \{(x, y) \mid x \neq y\},$$

$f$  is continuously differentiable on  $S$ .

**Example 5.3.9** The conditions of Theorem 5.3.10 are not necessary for differentiability; that is, a function may be differentiable at a point  $\mathbf{X}_0$  even if its first partial derivatives are not continuous at  $\mathbf{X}_0$ . For example, let

$$f(x, y) = \begin{cases} (x - y)^2 \sin \frac{1}{x - y}, & x \neq y, \\ 0, & x = y. \end{cases}$$

Then

$$f_x(x, y) = 2(x - y) \sin \frac{1}{x - y} - \cos \frac{1}{x - y}, \quad x \neq y,$$

and

$$f_x(x, x) = \lim_{h \rightarrow 0} \frac{f(x + h, x) - f(x, x)}{h} = \lim_{h \rightarrow 0} \frac{h^2 \sin(1/h) - 0}{h} = 0,$$

so  $f_x$  exists for all  $(x, y)$ , but is not continuous on the line  $y = x$ . The same is true of  $f_y$ , since

$$f_y(x, y) = -2(x - y) \sin \frac{1}{x - y} + \cos \frac{1}{x - y}, \quad x \neq y,$$

and

$$f_y(x, x) = \lim_{k \rightarrow 0} \frac{f(x, x + k) - f(x, x)}{k} = \lim_{k \rightarrow 0} \frac{k^2 \sin(-1/k) - 0}{k} = 0.$$

Now,

$$\frac{f(x, y) - f(0, 0) - f_x(0, 0)x - f_y(0, 0)y}{\sqrt{x^2 + y^2}} = \begin{cases} \frac{(x - y)^2}{\sqrt{x^2 + y^2}} \sin \frac{1}{x - y}, & x \neq y, \\ 0, & x = y, \end{cases}$$

and Schwarz's inequality implies that

$$\left| \frac{(x - y)^2}{\sqrt{x^2 + y^2}} \sin \frac{1}{x - y} \right| \leq \frac{2(x^2 + y^2)}{\sqrt{x^2 + y^2}} = 2\sqrt{x^2 + y^2}, \quad x \neq y.$$

Therefore,

$$\lim_{(x, y) \rightarrow (0, 0)} \frac{f(x, y) - f(0, 0) - f_x(0, 0)x - f_y(0, 0)y}{\sqrt{x^2 + y^2}} = 0,$$

so  $f$  is differentiable at  $(0, 0)$ , but  $f_x$  and  $f_y$  are not continuous at  $(0, 0)$ .

### Geometric Interpretation of Differentiability

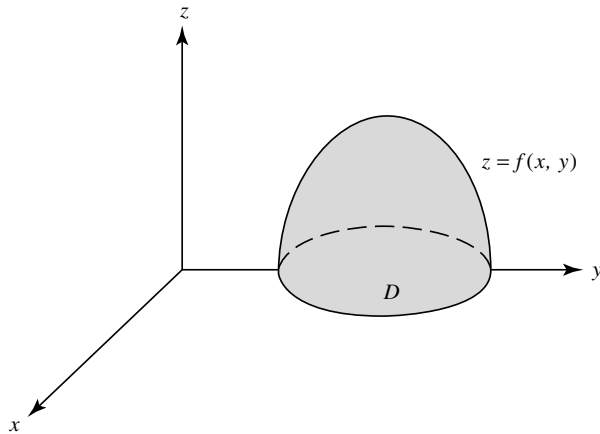
In Section 2.3 we saw that if a function  $f$  of one variable is differentiable at  $x_0$ , then the curve  $y = f(x)$  has a tangent line

$$y = T(x) = f(x_0) + f'(x_0)(x - x_0)$$

that approximates it so well near  $x_0$  that

$$\lim_{x \rightarrow x_0} \frac{f(x) - T(x)}{x - x_0} = 0.$$

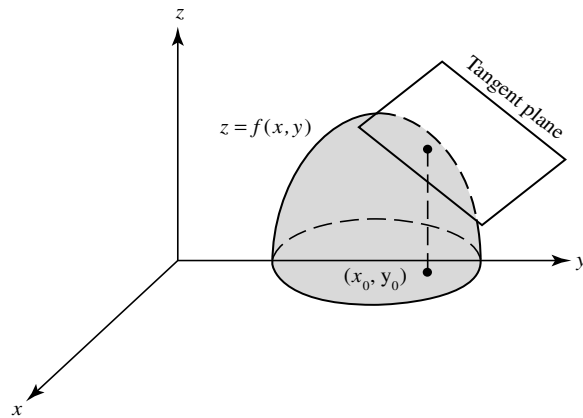
Moreover, the tangent line is the "limit" of the secant line through the points  $(x_1, f(x_1))$  and  $(x_0, f(x_0))$  as  $x_1$  approaches  $x_0$ .

**Figure 5.3.1**

Differentiability of a function of  $n$  variables has an analogous geometric interpretation. We will illustrate it for  $n = 2$ . If  $f$  is defined in a region  $D$  in  $\mathbb{R}^2$ , then the set of points  $(x, y, z)$  such that

$$z = f(x, y), \quad (x, y) \in D, \quad (5.3.27)$$

is a *surface* in  $\mathbb{R}^3$  (Figure 5.3.1).

**Figure 5.3.2**

If  $f$  is differentiable at  $\mathbf{X}_0 = (x_0, y_0)$ , then the plane

$$z = T(x, y) = f(\mathbf{X}_0) + f_x(\mathbf{X}_0)(x - x_0) + f_y(\mathbf{X}_0)(y - y_0) \quad (5.3.28)$$

intersects the surface (5.3.27) at  $(x_0, y_0, f(x_0, y_0))$  and approximates the surface so well near  $(x_0, y_0)$  that

$$\lim_{(x,y) \rightarrow (x_0,y_0)} \frac{f(x,y) - T(x,y)}{\sqrt{(x-x_0)^2 + (y-y_0)^2}} = 0$$

(Figure 5.3.2). Moreover, (5.3.28) is the only plane in  $\mathbb{R}^3$  with these properties (Exercise 5.3.25). We say that this plane is *tangent to the surface*  $z = f(x, y)$  *at the point*  $(x_0, y_0, f(x_0, y_0))$ . We will now show that it is the “limit” of “secant planes” associated with the surface  $z = f(x, y)$ , just as a tangent line to a curve  $y = f(x)$  in  $\mathbb{R}^3$  is the limit of secant lines to the curve (Section 2.3).

Let  $\mathbf{X}_i = (x_i, y_i)$  ( $i = 1, 2, 3$ ). The equation of the “secant plane” through the points  $(x_i, y_i, f(x_i, y_i))$  ( $i = 1, 2, 3$ ) on the surface  $z = f(x, y)$  (Figure 5.3.3) is of the form

$$z = f(\mathbf{X}_0) + A(x - x_0) + B(y - y_0), \quad (5.3.29)$$

where  $A$  and  $B$  satisfy the system

$$\begin{aligned} f(\mathbf{X}_1) &= f(\mathbf{X}_0) + A(x_1 - x_0) + B(y_1 - y_0), \\ f(\mathbf{X}_2) &= f(\mathbf{X}_0) + A(x_2 - x_0) + B(y_2 - y_0). \end{aligned}$$

Solving for  $A$  and  $B$  yields

$$A = \frac{(f(\mathbf{X}_1) - f(\mathbf{X}_0))(y_2 - y_0) - (f(\mathbf{X}_2) - f(\mathbf{X}_0))(y_1 - y_0)}{(x_1 - x_0)(y_2 - y_0) - (x_2 - x_0)(y_1 - y_0)} \quad (5.3.30)$$

and

$$B = \frac{(f(\mathbf{X}_2) - f(\mathbf{X}_0))(x_1 - x_0) - (f(\mathbf{X}_1) - f(\mathbf{X}_0))(x_2 - x_0)}{(x_1 - x_0)(y_2 - y_0) - (x_2 - x_0)(y_1 - y_0)} \quad (5.3.31)$$

if

$$(x_1 - x_0)(y_2 - y_0) - (x_2 - x_0)(y_1 - y_0) \neq 0, \quad (5.3.32)$$

which is equivalent to the requirement that  $\mathbf{X}_0$ ,  $\mathbf{X}_1$ , and  $\mathbf{X}_2$  do not lie on a line (Exercise 5.3.23). If we write

$$\mathbf{X}_1 = \mathbf{X}_0 + t\mathbf{U} \quad \text{and} \quad \mathbf{X}_2 = \mathbf{X}_0 + t\mathbf{V},$$

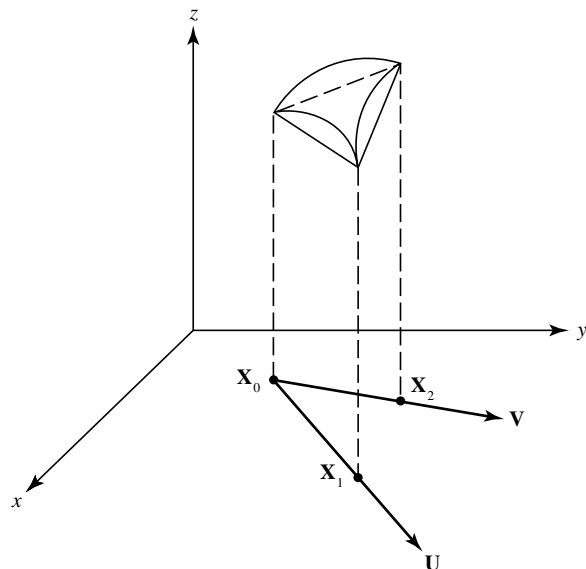
where  $\mathbf{U} = (u_1, u_2)$  and  $\mathbf{V} = (v_1, v_2)$  are fixed nonzero vectors (Figure 5.3.3), then (5.3.30), (5.3.31), and (5.3.32) take the more convenient forms

$$A = \frac{\frac{f(\mathbf{X}_0 + t\mathbf{U}) - f(\mathbf{X}_0)}{t} v_2 - \frac{f(\mathbf{X}_0 + t\mathbf{V}) - f(\mathbf{X}_0)}{t} u_2}{u_1 v_2 - u_2 v_1}, \quad (5.3.33)$$

$$B = \frac{\frac{f(\mathbf{X}_0 + t\mathbf{V}) - f(\mathbf{X}_0)}{t} u_1 - \frac{f(\mathbf{X}_0 + t\mathbf{U}) - f(\mathbf{X}_0)}{t} v_1}{u_1 v_2 - u_2 v_1}, \quad (5.3.34)$$

and

$$u_1 v_2 - u_2 v_1 \neq 0.$$


**Figure 5.3.3**

If  $f$  is differentiable at  $\mathbf{X}_0$ , then

$$f(\mathbf{X}) - f(\mathbf{X}_0) = f_x(\mathbf{X}_0)(x - x_0) + f_y(\mathbf{X}_0)(y - y_0) + \epsilon(\mathbf{X})|\mathbf{X} - \mathbf{X}_0|, \quad (5.3.35)$$

where

$$\lim_{\mathbf{X} \rightarrow \mathbf{X}_0} \epsilon(\mathbf{X}) = 0. \quad (5.3.36)$$

Substituting first  $\mathbf{X} = \mathbf{X}_0 + t\mathbf{U}$  and then  $\mathbf{X} = \mathbf{X}_0 + t\mathbf{V}$  in (5.3.35) and dividing by  $t$  yields

$$\frac{f(\mathbf{X}_0 + t\mathbf{U}) - f(\mathbf{X}_0)}{t} = f_x(\mathbf{X}_0)u_1 + f_y(\mathbf{X}_0)u_2 + E_1(t)|\mathbf{U}| \quad (5.3.37)$$

and

$$\frac{f(\mathbf{X}_0 + t\mathbf{V}) - f(\mathbf{X}_0)}{t} = f_x(\mathbf{X}_0)v_1 + f_y(\mathbf{X}_0)v_2 + E_2(t)|\mathbf{V}|, \quad (5.3.38)$$

where

$$E_1(t) = \epsilon(\mathbf{X}_0 + t\mathbf{U})|t|/t \quad \text{and} \quad E_2(t) = \epsilon(\mathbf{X}_0 + t\mathbf{V})|t|/t,$$

so

$$\lim_{t \rightarrow 0} E_i(t) = 0, \quad i = 1, 2, \quad (5.3.39)$$

because of (5.3.36). Substituting (5.3.37) and (5.3.38) into (5.3.33) and (5.3.34) yields

$$A = f_x(\mathbf{X}_0) + \Delta_1(t), \quad B = f_y(\mathbf{X}_0) + \Delta_2(t), \quad (5.3.40)$$

where

$$\Delta_1(t) = \frac{v_2|\mathbf{U}|E_1(t) - u_2|\mathbf{V}|E_2(t)}{u_1v_2 - u_2v_1}$$

and

$$\Delta_2(t) = \frac{u_1|\mathbf{V}|E_2(t) - v_1|\mathbf{U}|E_1(t)}{u_1v_2 - u_2v_1},$$

so

$$\lim_{t \rightarrow 0} \Delta_i(t) = 0, \quad i = 1, 2, \quad (5.3.41)$$

because of (5.3.39).

From (5.3.29) and (5.3.40), the equation of the secant plane is

$$z = f(\mathbf{X}_0) + [f_x(\mathbf{X}_0) + \Delta_1(t)](x - x_0) + [f_y(\mathbf{X}_0) + \Delta_2(t)](y - y_0).$$

Therefore, because of (5.3.41), the secant plane “approaches” the tangent plane (5.3.28) as  $t$  approaches zero.

## Maxima and Minima

We say that  $\mathbf{X}_0$  is a *local extreme point* of  $f$  if there is a  $\delta > 0$  such that

$$f(\mathbf{X}) - f(\mathbf{X}_0)$$

does not change sign in  $S_\delta(\mathbf{X}_0) \cap D_f$ . More specifically,  $\mathbf{X}_0$  is a *local maximum point* if

$$f(\mathbf{X}) \leq f(\mathbf{X}_0)$$

or a *local minimum point* if

$$f(\mathbf{X}) \geq f(\mathbf{X}_0)$$

for all  $\mathbf{X}$  in  $S_\delta(\mathbf{X}_0) \cap D_f$ .

The next theorem is analogous to Theorem 2.3.7.

**Theorem 5.3.11** *Suppose that  $f$  is defined in a neighborhood of  $\mathbf{X}_0$  in  $\mathbb{R}^n$  and  $f_{x_1}(\mathbf{X}_0)$ ,  $f_{x_2}(\mathbf{X}_0)$ ,  $\dots$ ,  $f_{x_n}(\mathbf{X}_0)$  exist. Let  $\mathbf{X}_0$  be a local extreme point of  $f$ . Then*

$$f_{x_i}(\mathbf{X}_0) = 0, \quad 1 \leq i \leq n. \quad (5.3.42)$$

**Proof** Let

$$\mathbf{E}_1 = (1, 0, \dots, 0), \quad \mathbf{E}_2 = (0, 1, 0, \dots, 0), \dots, \quad \mathbf{E}_n = (0, 0, \dots, 1),$$

and

$$g_i(t) = f(\mathbf{X}_0 + t\mathbf{E}_i), \quad 1 \leq i \leq n.$$

Then  $g_i$  is differentiable at  $t = 0$ , with

$$g'_i(0) = f_{x_i}(\mathbf{X}_0)$$

(Definition 5.3.1). Since  $\mathbf{X}_0$  is a local extreme point of  $f$ ,  $t_0 = 0$  is a local extreme point of  $g_i$ . Now Theorem 2.3.7 implies that  $g'_i(0) = 0$ , and this implies (5.3.42). ■

The converse of Theorem 5.3.11 is false, since (5.3.42) may hold at a point  $\mathbf{X}_0$  that is not a local extreme point of  $f$ . For example, let  $\mathbf{X}_0 = (0, 0)$  and

$$f(x, y) = x^3 + y^3.$$

We say that a point  $\mathbf{X}_0$  where (5.3.42) holds is a *critical point* of  $f$ . Thus, if  $f$  is defined in a neighborhood of a local extreme point  $\mathbf{X}_0$ , then  $\mathbf{X}_0$  is a critical point of  $f$ ; however, a critical point need not be a local extreme point of  $f$ .

The use of Theorem 5.3.11 for finding local extreme points is covered in calculus, so we will not pursue it here.

### 5.3 Exercises

1. Calculate  $\partial f(\mathbf{X})/\partial \Phi$ .

(a)  $f(x, y) = x^2 + 2xy \cos x$ ,  $\Phi = \left( \frac{1}{\sqrt{3}}, -\sqrt{\frac{2}{3}} \right)$

(b)  $f(x, y, z) = e^{-x+y^2+2z}$ ,  $\Phi = \left( \frac{1}{\sqrt{3}}, -\frac{1}{\sqrt{3}}, \frac{1}{\sqrt{3}} \right)$

(c)  $f(\mathbf{X}) = |\mathbf{X}|^2$ ,  $\Phi = \left( \frac{1}{\sqrt{n}}, \frac{1}{\sqrt{n}}, \dots, \frac{1}{\sqrt{n}} \right)$

(d)  $f(x, y, z) = \log(1 + x + y + z)$ ,  $\Phi = (0, 1, 0)$

2. Let

$$f(x, y) = \begin{cases} \frac{xy \sin x}{x^2 + y^2}, & (x, y) \neq (0, 0), \\ 0, & (x, y) = (0, 0), \end{cases}$$

and let  $\Phi = (\phi_1, \phi_2)$  be a unit vector. Find  $\partial f(0, 0)/\partial \Phi$ .

3. Find  $\partial f(\mathbf{X}_0)/\partial \Phi$ , where  $\Phi$  is the unit vector in the direction of  $\mathbf{X}_1 - \mathbf{X}_0$ .

(a)  $f(x, y, z) = \sin \pi xyz$ ;  $\mathbf{X}_0 = (1, 1, -2)$ ,  $\mathbf{X}_1 = (3, 2, -1)$

(b)  $f(x, y, z) = e^{-(x^2+y^2+2z)}$ ;  $\mathbf{X}_0 = (1, 0, -1)$ ,  $\mathbf{X}_1 = (2, 0, -1)$

(c)  $f(x, y, z) = \log(1 + x + y + z)$ ;  $\mathbf{X}_0 = (1, 0, 1)$ ,  $\mathbf{X}_1 = (3, 0, -1)$

(d)  $f(\mathbf{X}) = |\mathbf{X}|^4$ ;  $\mathbf{X}_0 = \mathbf{0}$ ,  $\mathbf{X}_1 = (1, 1, \dots, 1)$

4. Give a geometrical interpretation of the directional derivative  $\partial f(x_0, y_0)/\partial \Phi$  of a function of two variables.

5. Find all first-order partial derivatives.

(a)  $f(x, y, z) = \log(x + y + 2z)$     (b)  $f(x, y, z) = x^2 + 3xyz + 2xy$

(c)  $f(x, y, z) = xe^{yz}$     (d)  $f(x, y, z) = z + \sin x^2 y$

6. Find all second-order partial derivatives of the functions in Exercise 5.3.5.



7. Find all second-order partial derivatives of the following functions at  $(0, 0)$ .

$$(a) \quad f(x, y) = \begin{cases} \frac{xy(x^2 - y^2)}{x^2 + y^2}, & (x, y) \neq (0, 0), \\ 0, & (x, y) = (0, 0) \end{cases}$$

$$(b) \quad f(x, y) = \begin{cases} x^2 \tan^{-1} \frac{y}{x} - y^2 \tan^{-1} \frac{x}{y}, & x \neq 0, \quad y \neq 0, \\ 0, & x = 0 \quad \text{or} \quad y = 0 \end{cases}$$

(Here  $|\tan^{-1} u| < \pi/2$ .)

8. Find a function  $f = f(x, y)$  such that  $f_{xy}$  exists for all  $(x, y)$ , but  $f_y$  exists nowhere.
9. Let  $u$  and  $v$  be functions of two variables with continuous second-order partial derivatives in a region  $S$ . Suppose that  $u_x = v_y$  and  $u_y = -v_x$  in  $S$ . Show that

$$u_{xx} + u_{yy} = v_{xx} + v_{yy} = 0$$

in  $S$ .

10. Let  $f$  be a function of  $(x_1, x_2, \dots, x_n)$  ( $n \geq 2$ ) such that  $f_{x_i}$ ,  $f_{x_j}$ , and  $f_{x_i x_j}$  ( $i \neq j$ ) exist on a neighborhood of  $\mathbf{X}_0$  and  $f_{x_i x_j}$  is continuous at  $\mathbf{X}_0$ . Use Theorem 5.3.3 to prove that  $f_{x_j x_i}(\mathbf{X}_0)$  exists and equals  $f_{x_i x_j}(\mathbf{X}_0)$ .
11. Use Exercise 5.3.10 and induction on  $r$  to prove Theorem 5.3.4.
12. Let  $r_1, r_2, \dots, r_n$  be nonnegative integers such that

$$r_1 + r_2 + \dots + r_n = r \geq 0.$$

- (a) Show that

$$(z_1 + z_2 + \dots + z_n)^r = \sum_r \frac{r!}{r_1! r_2! \dots r_n!} z_1^{r_1} z_2^{r_2} \dots z_n^{r_n},$$

where  $\sum_r$  denotes summation over all  $n$ -tuples  $(r_1, r_2, \dots, r_n)$  that satisfy the stated conditions. HINT: This is obvious if  $n = 1$ , and it follows from Exercise 1.2.19 if  $n = 2$ . Use induction on  $n$ .

- (b) Show that there are

$$\frac{r!}{r_1! r_2! \dots r_n!}$$

ordered  $n$ -tuples of integers  $(i_1, i_2, \dots, i_n)$  that contain  $r_1$  ones,  $r_2$  twos,  $\dots$ , and  $r_n$   $n$ 's.

- (c) Let  $f$  be a function of  $(x_1, x_2, \dots, x_n)$ . Show that there are

$$\frac{r!}{r_1! r_2! \dots r_n!}$$

partial derivatives  $f_{x_{i_1} x_{i_2} \dots x_{i_r}}$  that involve differentiation  $r_i$  times with respect to  $x_i$ , for  $i = 1, 2, \dots, n$ .

13. Prove Lemma 5.3.8.

14. Show that the function

$$f(x, y) = \begin{cases} \frac{x^2 y}{x^6 + 2y^2}, & (x, y) \neq (0, 0), \\ 0, & (x, y) = (0, 0), \end{cases}$$

has a directional derivative in the direction of an arbitrary unit vector  $\Phi$  at  $(0, 0)$ , but  $f$  is not continuous at  $(0, 0)$ .

15. Prove: If  $f_x$  and  $f_y$  are bounded in a neighborhood of  $(x_0, y_0)$ , then  $f$  is continuous at  $(x_0, y_0)$ .
16. Show directly from Definition 5.3.5 that  $f$  is differentiable at  $\mathbf{X}_0$ .
- (a)  $f(x, y) = 2x^2 + 3xy + y^2$ ,  $\mathbf{X}_0 = (1, 2)$   
 (b)  $f(x, y, z) = 2x^2 + 3x + 4yz$ ,  $\mathbf{X}_0 = (1, 1, 1)$   
 (c)  $f(\mathbf{X}) = |\mathbf{X}|^2$ ,  $\mathbf{X}_0$  arbitrary
17. Suppose that  $f_x$  exists on a neighborhood of  $(x_0, y_0)$  and is continuous at  $(x_0, y_0)$ , while  $f_y$  merely exists at  $(x_0, y_0)$ . Show that  $f$  is differentiable at  $(x_0, y_0)$ .
18. Find  $df$  and  $d_{\mathbf{X}_0} f$ , and write  $(d_{\mathbf{X}_0} f)(\mathbf{X} - \mathbf{X}_0)$ .
- (a)  $f(x, y) = x^3 + 4xy^2 + 2xy \sin x$ ,  $\mathbf{X}_0 = (0, -2)$   
 (b)  $f(x, y, z) = e^{-(x+y+z)}$ ,  $\mathbf{X}_0 = (0, 0, 0)$   
 (c)  $f(\mathbf{X}) = \log(1 + x_1 + 2x_2 + 3x_3 + \cdots + nx_n)$ ,  $\mathbf{X}_0 = \mathbf{0}$   
 (d)  $f(\mathbf{X}) = |\mathbf{X}|^{2r}$ ,  $\mathbf{X}_0 = (1, 1, 1, \dots, 1)$
19. (a) Suppose that  $f$  is differentiable at  $\mathbf{X}_0$  and  $\Phi = (\phi_1, \phi_2, \dots, \phi_n)$  is a unit vector. Show that

$$\frac{\partial f(\mathbf{X}_0)}{\partial \Phi} = f_{x_1}(\mathbf{X}_0)\phi_1 + f_{x_2}(\mathbf{X}_0)\phi_2 + \cdots + f_{x_n}(\mathbf{X}_0)\phi_n.$$

(b) For what unit vector  $\Phi$  does  $\partial f(\mathbf{X}_0)/\partial \Phi$  attain its maximum value?

20. Let  $f$  be defined on  $\mathbb{R}^n$  by

$$f(\mathbf{X}) = g(x_1) + g(x_2) + \cdots + g(x_n),$$

where

$$g(u) = \begin{cases} u^2 \sin \frac{1}{u}, & u \neq 0, \\ 0, & u = 0. \end{cases}$$

Show that  $f$  is differentiable at  $(0, 0, \dots, 0)$ , but  $f_{x_1}, f_{x_2}, \dots, f_{x_n}$  are all discontinuous at  $(0, 0, \dots, 0)$ .

21. The purpose of this exercise is to show that if  $f$ ,  $f_x$  and  $f_y$  exist on a neighborhood  $N$  of  $(x_0, y_0)$  and  $f_x$  and  $f_y$  are differentiable at  $(x_0, y_0)$ , then  $f_{xy}(x_0, y_0) = f_{yx}(x_0, y_0)$ . Suppose that the open square

$$\{(x, y) \mid |x - x_0| < |h|, |y - y_0| < |h|\}$$

is in  $N$ . Consider

$$B(h) = f(x_0 + h, y_0 + h) - f(x_0 + h, y_0) - f(x_0, y_0 + h) + f(x_0, y_0).$$

- (a) Use the mean value theorem as we did in the proof of Theorem 5.3.3 to write

$$B(h) = [f_x(\hat{x}, y_0 + k) - f_x(\hat{x}, y_0)]h,$$

where  $\hat{x}$  is between  $x_0$  and  $x_0 + h$ . Then use the differentiability of  $f_x$  at  $(x_0, y_0)$  to infer that

$$B(h) = h^2 f_{xy}(x_0, y_0) + hE_1(h), \quad \text{where} \quad \lim_{h \rightarrow 0} \frac{E_1(h)}{h} = 0.$$

- (b) Use the mean value theorem to write

$$B(h) = [f_y(x_0 + h, \hat{y}) - f_y(x_0, \hat{y})]h,$$

where  $\hat{y}$  is between  $y_0$  and  $y_0 + h$ . Then use the differentiability of  $f_y$  at  $(x_0, y_0)$  to infer that

$$B(h) = h^2 f_{yx}(x_0, y_0) + hE_2(h), \quad \text{where} \quad \lim_{h \rightarrow 0} \frac{E_2(h)}{h} = 0.$$

- (c) Infer from (a) and (b) that  $f_{xy}(x_0, y_0) = f_{yx}(x_0, y_0)$ .

22. (a) Let  $f_{x_i}$  and  $f_{x_j}$  be differentiable at a point  $\mathbf{X}_0$  in  $\mathbb{R}^n$ . Show from Exercise 5.3.21 that

$$f_{x_i x_j}(\mathbf{X}_0) = f_{x_j x_i}(\mathbf{X}_0).$$

- (b) Use (a) and induction on  $r$  to show that all  $(r - 1)$ -st order partial derivatives of  $f$  are differentiable on an open subset  $S$  of  $\mathbb{R}^n$ , then  $f_{x_{i_1} x_{i_2} \dots x_{i_r}}(\mathbf{X})$  ( $\mathbf{X} \in S$ ) depends only on the number of differentiations with respect to each variable, and not on the order in which they are performed.

23. Prove that  $(x_0, y_0)$ ,  $(x_1, y_1)$ , and  $(x_2, y_2)$  lie on a line if and only if

$$(x_1 - x_0)(y_2 - y_0) - (x_2 - x_0)(y_1 - y_0) = 0.$$

24. Find the equation of the tangent plane to the surface

$$z = f(x, y) \quad \text{at} \quad (x_0, y_0, z_0) = (x_0, y_0, f(x_0, y_0)).$$

- (a)  $f(x, y) = x^2 + y^2 - 1$ ,  $(x_0, y_0) = (1, 2)$   
 (b)  $f(x, y) = 2x + 3y + 1$ ,  $(x_0, y_0) = (1, -1)$   
 (c)  $f(x, y) = xy \sin xy$ ,  $(x_0, y_0) = (1, \pi/2)$   
 (d)  $f(x, y) = x^2 - 2y^2 + 3xy$ ,  $(x_0, y_0) = (2, -1)$

25. Prove: If  $f$  is differentiable at  $(x_0, y_0)$  and

$$\lim_{(x,y) \rightarrow (x_0,y_0)} \frac{f(x,y) - a - b(x - x_0) - c(y - y_0)}{\sqrt{(x - x_0)^2 + (y - y_0)^2}} = 0,$$

then  $a = f(x_0, y_0)$ ,  $b = f_x(x_0, y_0)$ , and  $c = f_y(x_0, y_0)$ .

## 5.4 THE CHAIN RULE AND TAYLOR'S THEOREM

We now consider the problem of differentiating a composite function

$$h(\mathbf{U}) = f(\mathbf{G}(\mathbf{U})),$$

where  $\mathbf{G} = (g_1, g_2, \dots, g_n)$  is a vector-valued function, as defined in Section 5.2. We begin with the following definition.

**Definition 5.4.1** A vector-valued function  $\mathbf{G} = (g_1, g_2, \dots, g_n)$  is *differentiable* at

$$\mathbf{U}_0 = (u_{10}, u_{20}, \dots, u_{m0})$$

if its component functions  $g_1, g_2, \dots, g_n$  are differentiable at  $\mathbf{U}_0$ . ■

We need the following lemma to prove the main result of the section.

**Lemma 5.4.2** Suppose that  $\mathbf{G} = (g_1, g_2, \dots, g_n)$  is differentiable at

$$\mathbf{U}_0 = (u_{10}, u_{20}, \dots, u_{m0}),$$

and define

$$M = \left( \sum_{i=1}^n \sum_{j=1}^m \left( \frac{\partial g_i(\mathbf{U}_0)}{\partial u_j} \right)^2 \right)^{1/2}.$$

Then, if  $\epsilon > 0$ , there is a  $\delta > 0$  such that

$$\frac{|\mathbf{G}(\mathbf{U}) - \mathbf{G}(\mathbf{U}_0)|}{|\mathbf{U} - \mathbf{U}_0|} < M + \epsilon \quad \text{if} \quad 0 < |\mathbf{U} - \mathbf{U}_0| < \delta.$$

**Proof** Since  $g_1, g_2, \dots, g_n$  are differentiable at  $\mathbf{U}_0$ , applying Lemma 5.3.8 to  $g_i$  shows that

$$\begin{aligned} g_i(\mathbf{U}) - g_i(\mathbf{U}_0) &= (d_{\mathbf{U}_0} g_i)(\mathbf{U} - \mathbf{U}_0) + E_i(\mathbf{U})|\mathbf{U} - \mathbf{U}_0| \\ &= \sum_{j=1}^m \frac{\partial g_i(\mathbf{U}_0)}{\partial u_j} (u_j - u_{j0}) + E_i(\mathbf{U})|\mathbf{U} - \mathbf{U}_0|, \end{aligned} \quad (5.4.1)$$

where

$$\lim_{\mathbf{U} \rightarrow \mathbf{U}_0} E_i(\mathbf{U}) = 0, \quad 1 \leq i \leq n. \quad (5.4.2)$$

From Schwarz's inequality,

$$|g_i(\mathbf{U}) - g_i(\mathbf{U}_0)| \leq (M_i + |E_i(\mathbf{U})|)|\mathbf{U} - \mathbf{U}_0|,$$

where

$$M_i = \left( \sum_{j=1}^m \left( \frac{\partial g_i(\mathbf{U}_0)}{\partial u_j} \right)^2 \right)^{1/2}.$$

Therefore,

$$\frac{|\mathbf{G}(\mathbf{U}) - \mathbf{G}(\mathbf{U}_0)|}{|\mathbf{U} - \mathbf{U}_0|} \leq \left( \sum_{i=1}^n (M_i + |E_i(\mathbf{U})|)^2 \right)^{1/2}.$$

From (5.4.2),

$$\lim_{\mathbf{U} \rightarrow \mathbf{U}_0} \left( \sum_{i=1}^n (M_i + |E_i(\mathbf{U})|)^2 \right)^{1/2} = \left( \sum_{i=1}^n M_i^2 \right)^{1/2} = M,$$

which implies the conclusion. ■

The following theorem is analogous to Theorem 2.3.5.

**Theorem 5.4.3 (The Chain Rule)** *Suppose that the real-valued function  $f$  is differentiable at  $\mathbf{X}_0$  in  $\mathbb{R}^n$ , the vector-valued function  $\mathbf{G} = (g_1, g_2, \dots, g_n)$  is differentiable at  $\mathbf{U}_0$  in  $\mathbb{R}^m$ , and  $\mathbf{X}_0 = \mathbf{G}(\mathbf{U}_0)$ . Then the real-valued composite function  $h = f \circ \mathbf{G}$  defined by*

$$h(\mathbf{U}) = f(\mathbf{G}(\mathbf{U})) \quad (5.4.3)$$

is differentiable at  $\mathbf{U}_0$ , and

$$d_{\mathbf{U}_0} h = f_{x_1}(\mathbf{X}_0) d_{\mathbf{U}_0} g_1 + f_{x_2}(\mathbf{X}_0) d_{\mathbf{U}_0} g_2 + \cdots + f_{x_n}(\mathbf{X}_0) d_{\mathbf{U}_0} g_n. \quad (5.4.4)$$

**Proof** We leave it to you to show that  $\mathbf{U}_0$  is an interior point of the domain of  $h$  (Exercise 5.4.1), so it is legitimate to ask if  $h$  is differentiable at  $\mathbf{U}_0$ .

Let  $\mathbf{X}_0 = (x_{10}, x_{20}, \dots, x_{n0})$ . Note that

$$x_{i0} = g_i(\mathbf{U}_0), \quad 1 \leq i \leq n,$$

by assumption. Since  $f$  is differentiable at  $\mathbf{X}_0$ , Lemma 5.3.8 implies that

$$f(\mathbf{X}) - f(\mathbf{X}_0) = \sum_{i=1}^n f_{x_i}(\mathbf{X}_0)(x_i - x_{i0}) + E(\mathbf{X})|\mathbf{X} - \mathbf{X}_0|, \quad (5.4.5)$$

where

$$\lim_{\mathbf{X} \rightarrow \mathbf{X}_0} E(\mathbf{X}) = 0.$$

Substituting  $\mathbf{X} = \mathbf{G}(\mathbf{U})$  and  $\mathbf{X}_0 = \mathbf{G}(\mathbf{U}_0)$  in (5.4.5) and recalling (5.4.3) yields

$$h(\mathbf{U}) - h(\mathbf{U}_0) = \sum_{i=1}^n f_{x_i}(\mathbf{X}_0)(g_i(\mathbf{U}) - g_i(\mathbf{U}_0)) + E(\mathbf{G}(\mathbf{U}))|\mathbf{G}(\mathbf{U}) - \mathbf{G}(\mathbf{U}_0)|. \quad (5.4.6)$$

Substituting (5.4.1) into (5.4.6) yields

$$\begin{aligned} h(\mathbf{U}) - h(\mathbf{U}_0) &= \sum_{i=1}^n f_{x_i}(\mathbf{X}_0)(d_{\mathbf{U}_0}g_i)(\mathbf{U} - \mathbf{U}_0) + \left( \sum_{i=1}^n f_{x_i}(\mathbf{X}_0)E_i(\mathbf{U}) \right) |\mathbf{U} - \mathbf{U}_0| \\ &\quad + E(\mathbf{G}(\mathbf{U}))|\mathbf{G}(\mathbf{U}) - \mathbf{G}(\mathbf{U}_0)|. \end{aligned}$$

Since

$$\lim_{\mathbf{U} \rightarrow \mathbf{U}_0} E(\mathbf{G}(\mathbf{U})) = \lim_{\mathbf{X} \rightarrow \mathbf{X}_0} E(\mathbf{X}) = 0,$$

(5.4.2) and Lemma 5.4.2 imply that

$$\frac{h(\mathbf{U}) - h(\mathbf{U}_0) - \sum_{i=1}^n f_{x_i}(\mathbf{X}_0)d_{\mathbf{U}_0}g_i(\mathbf{U} - \mathbf{U}_0)}{|\mathbf{U} - \mathbf{U}_0|} = 0.$$

Therefore,  $h$  is differentiable at  $\mathbf{U}_0$ , and  $d_{\mathbf{U}_0}h$  is given by (5.4.4). ■

**Example 5.4.1** Let

$$\begin{aligned} f(x, y, z) &= 2x^2 + 4xy + 3yz, \\ g_1(u, v) &= u^2 + v^2, \quad g_2(u, v) = u^2 - 2v^2, \quad g_3(u, v) = uv, \end{aligned}$$

and

$$h(u, v) = f(g_1(u, v), g_2(u, v), g_3(u, v)).$$

Let  $\mathbf{U}_0 = (1, -1)$  and

$$\mathbf{X}_0 = (g_1(\mathbf{U}_0), g_2(\mathbf{U}_0), g_3(\mathbf{U}_0)) = (2, -1, -1).$$

Then

$$f_x(\mathbf{X}_0) = 4, \quad f_y(\mathbf{X}_0) = 5, \quad f_z(\mathbf{X}_0) = -3,$$

$$\begin{aligned} \frac{\partial g_1(\mathbf{U}_0)}{\partial u} &= 2, & \frac{\partial g_1(\mathbf{U}_0)}{\partial v} &= -2, \\ \frac{\partial g_2(\mathbf{U}_0)}{\partial u} &= 2, & \frac{\partial g_2(\mathbf{U}_0)}{\partial v} &= 4, \\ \frac{\partial g_3(\mathbf{U}_0)}{\partial u} &= -1, & \frac{\partial g_3(\mathbf{U}_0)}{\partial v} &= 1. \end{aligned}$$

Therefore,

$$d_{\mathbf{U}_0}g_1 = 2 du - 2 dv, \quad d_{\mathbf{U}_0}g_2 = 2 du + 4 dv, \quad d_{\mathbf{U}_0}g_3 = -du + dv,$$

and, from (5.4.4),

$$\begin{aligned} d_{\mathbf{U}_0}h &= f_x(\mathbf{X}_0) d_{\mathbf{U}_0}g_1 + f_y(\mathbf{X}_0) d_{\mathbf{U}_0}g_2 + f_z(\mathbf{X}_0) d_{\mathbf{U}_0}g_3 \\ &= 4(2 du - 2 dv) + 5(2 du + 4 dv) - 3(-du + dv) \\ &= 21 du + 9 dv. \end{aligned}$$

Since

$$d_{\mathbf{U}_0}h = h_u(\mathbf{U}_0) du + h_v(\mathbf{U}_0) dv$$

we conclude that

$$h_u(\mathbf{U}_0) = 21 \quad \text{and} \quad h_v(\mathbf{U}_0) = 9. \quad (5.4.7)$$

This can also be obtained by writing  $h$  explicitly in terms of  $(u, v)$  and differentiating; thus,

$$\begin{aligned} h(u, v) &= 2[g_1(u, v)]^2 + 4g_1(u, v)g_2(u, v) + 3g_2(u, v)g_3(u, v) \\ &= 2(u^2 + v^2)^2 + 4(u^2 + v^2)(u^2 - 2v^2) + 3(u^2 - 2v^2)uv \\ &= 6u^4 + 3u^3v - 6uv^3 - 6v^4. \end{aligned}$$

Hence,

$$h_u(u, v) = 24u^3 + 9u^2v - 6v^3 \quad \text{and} \quad h_v(u, v) = 3u^3 - 18uv^2 - 24v^3,$$

so  $h_u(1, -1) = 21$  and  $h_v(1, -1) = 9$ , consistent with (5.4.7).

**Corollary 5.4.4** *Under the assumptions of Theorem 5.4.3,*

$$\frac{\partial h(\mathbf{U}_0)}{\partial u_i} = \sum_{j=1}^n \frac{\partial f(\mathbf{X}_0)}{\partial x_j} \frac{\partial g_j(\mathbf{U}_0)}{\partial u_i}, \quad 1 \leq i \leq m. \quad (5.4.8)$$

**Proof** Substituting

$$d_{\mathbf{U}_0}g_i = \frac{\partial g_i(\mathbf{U}_0)}{\partial u_1} du_1 + \frac{\partial g_i(\mathbf{U}_0)}{\partial u_2} du_2 + \cdots + \frac{\partial g_i(\mathbf{U}_0)}{\partial u_m} du_m, \quad 1 \leq i \leq n,$$

into (5.4.4) and collecting multipliers of  $du_1, du_2, \dots, du_m$  yields

$$d_{\mathbf{U}_0}h = \sum_{i=1}^m \left( \sum_{j=1}^n \frac{\partial f(\mathbf{X}_0)}{\partial x_j} \frac{\partial g_j(\mathbf{U}_0)}{\partial u_i} \right) du_i.$$

However, from Theorem 5.3.6,

$$d_{\mathbf{U}_0}h = \sum_{i=1}^m \frac{\partial h(\mathbf{U}_0)}{\partial u_i} du_i.$$

Comparing the last two equations yields (5.4.8). ■

When it is not important to emphasize the particular point  $\mathbf{X}_0$ , we write (5.4.8) less formally as

$$\frac{\partial h}{\partial u_i} = \sum_{j=1}^n \frac{\partial f}{\partial x_j} \frac{\partial g_j}{\partial u_i}, \quad 1 \leq i \leq m, \quad (5.4.9)$$

with the understanding that in calculating  $\partial h(\mathbf{U}_0)/\partial u_i$ ,  $\partial g_j/\partial u_i$  is evaluated at  $\mathbf{U}_0$  and  $\partial f/\partial x_j$  at  $\mathbf{X}_0 = \mathbf{G}(\mathbf{U}_0)$ .

The formulas (5.4.8) and (5.4.9) can also be simplified by replacing the symbol  $\mathbf{G}$  with  $\mathbf{X} = \mathbf{X}(\mathbf{U})$ ; then we write

$$h(\mathbf{U}) = f(\mathbf{X}(\mathbf{U}))$$

and

$$\frac{\partial h(\mathbf{U}_0)}{\partial u_i} = \sum_{j=1}^n \frac{\partial f(\mathbf{X}_0)}{\partial x_j} \frac{\partial x_j(\mathbf{U}_0)}{\partial u_i},$$

or simply

$$\frac{\partial h}{\partial u_i} = \sum_{j=1}^n \frac{\partial f}{\partial x_j} \frac{\partial x_j}{\partial u_i}. \quad (5.4.10)$$

**Example 5.4.2** Let  $(r, \theta)$  be polar coordinates in the  $xy$ -plane; that is,

$$x = r \cos \theta, \quad y = r \sin \theta.$$

Suppose that  $f = f(x, y)$  is differentiable on a set  $S$ , and let

$$h(r, \theta) = f(r \cos \theta, r \sin \theta).$$

If  $(r \cos \theta, r \sin \theta) \in S$ , (5.4.10) implies that

$$\frac{\partial h}{\partial r} = \frac{\partial f}{\partial x} \frac{\partial x}{\partial r} + \frac{\partial f}{\partial y} \frac{\partial y}{\partial r} = \cos \theta \frac{\partial f}{\partial x} + \sin \theta \frac{\partial f}{\partial y} \quad (5.4.11)$$

and

$$\frac{\partial h}{\partial \theta} = \frac{\partial f}{\partial x} \frac{\partial x}{\partial \theta} + \frac{\partial f}{\partial y} \frac{\partial y}{\partial \theta} = -r \sin \theta \frac{\partial f}{\partial x} + r \cos \theta \frac{\partial f}{\partial y},$$

where  $f_x$  and  $f_y$  are evaluated at  $(x, y) = (r \cos \theta, r \sin \theta)$ . ■

The proof of Corollary 5.4.4 suggests a straightforward way to calculate the partial derivatives of a composite function without using (5.4.10) explicitly. If  $h(\mathbf{U}) = f(\mathbf{X}(\mathbf{U}))$ , then Theorem 5.4.3, in the more casual notation introduced before Example 5.4.2, implies that

$$dh = f_{x_1} dx_1 + f_{x_2} dx_2 + \cdots + f_{x_n} dx_n, \quad (5.4.12)$$

where  $dx_1, dx_2, \dots, dx_n$  must be written in terms of the differentials  $du_1, du_2, \dots, du_m$  of the independent variables; thus,



$$dx_i = \frac{\partial x_i}{\partial u_1} du_1 + \frac{\partial x_i}{\partial u_2} du_2 + \cdots + \frac{\partial x_i}{\partial u_m} du_m.$$

Substituting this into (5.4.12) and collecting the multipliers of  $du_1, du_2, \dots, du_m$  yields (5.4.10).

**Example 5.4.3** If

$$h(r, \theta, z) = f(x(r, \theta), y(r, \theta), z),$$

then

$$dh = f_x dx + f_y dy + f_z dz.$$

But

$$dx = \frac{\partial x}{\partial r} dr + \frac{\partial x}{\partial \theta} d\theta \quad \text{and} \quad dy = \frac{\partial y}{\partial r} dr + \frac{\partial y}{\partial \theta} d\theta;$$

hence,

$$\begin{aligned} dh &= f_x \left( \frac{\partial x}{\partial r} dr + \frac{\partial x}{\partial \theta} d\theta \right) + f_y \left( \frac{\partial y}{\partial r} dr + \frac{\partial y}{\partial \theta} d\theta \right) + f_z dz \\ &= \left( f_x \frac{\partial x}{\partial r} + f_y \frac{\partial y}{\partial r} \right) dr + \left( f_x \frac{\partial x}{\partial \theta} + f_y \frac{\partial y}{\partial \theta} \right) d\theta + f_z dz, \end{aligned}$$

so

$$h_r = f_x \frac{\partial x}{\partial r} + f_y \frac{\partial y}{\partial r}, \quad h_\theta = f_x \frac{\partial x}{\partial \theta} + f_y \frac{\partial y}{\partial \theta}, \quad h_z = f_z.$$

**Example 5.4.4** Let

$$h(x) = f(x, y(x, z(x)), z(x)).$$

Then

$$dh = f_x dx + f_y dy + f_z dz, \quad (5.4.13)$$

$$dy = y_x dx + y_z dz, \quad (5.4.14)$$

and

$$dz = z' dx, \quad (5.4.15)$$

where the prime indicates differentiation with respect to  $x$ . Substituting (5.4.15) into (5.4.14) yields

$$dy = (y_x + y_z z') dx$$

and substituting this and (5.4.15) into (5.4.13) yields

$$dh = [f_x + f_y(y_x + y_z z') + f_z z'] dx;$$

hence,

$$h' = f_x + f_y(y_x + y_z z') + f_z z'.$$

Here  $f_x$ ,  $f_y$ , and  $f_z$  are evaluated at  $(x, y(x, z(x)), z(x))$ ,  $y_x$  and  $y_z$  are evaluated at  $(x, z(x))$ , and  $z'$  is evaluated at  $x$ .

### Higher Derivatives of Composite Functions

Higher derivatives of composite functions can be computed by repeatedly applying the chain rule. For example, differentiating (5.4.10) with respect to  $u_k$  yields

$$\begin{aligned}\frac{\partial^2 h}{\partial u_k \partial u_i} &= \sum_{j=1}^n \frac{\partial}{\partial u_k} \left( \frac{\partial f}{\partial x_j} \frac{\partial x_j}{\partial u_i} \right) \\ &= \sum_{j=1}^n \frac{\partial f}{\partial x_j} \frac{\partial^2 x_j}{\partial u_k \partial u_i} + \sum_{j=1}^n \frac{\partial x_j}{\partial u_i} \frac{\partial}{\partial u_k} \left( \frac{\partial f}{\partial x_j} \right).\end{aligned}\quad (5.4.16)$$

We must be careful finding

$$\frac{\partial}{\partial u_k} \left( \frac{\partial f}{\partial x_j} \right),$$

which really stands here for

$$\frac{\partial}{\partial u_k} \left( \frac{\partial f(\mathbf{X}(\mathbf{U}))}{\partial x_j} \right).\quad (5.4.17)$$

The safest procedure is to write temporarily

$$g(\mathbf{X}) = \frac{\partial f(\mathbf{X})}{\partial x_j};$$

then (5.4.17) becomes

$$\frac{\partial g(\mathbf{X}(\mathbf{U}))}{\partial u_k} = \sum_{s=1}^n \frac{\partial g(\mathbf{X}(\mathbf{U}))}{\partial x_s} \frac{\partial x_s(\mathbf{U})}{\partial u_k}.$$

Since

$$\frac{\partial g}{\partial x_s} = \frac{\partial^2 f}{\partial x_s \partial x_j},$$

this yields

$$\frac{\partial}{\partial u_k} \left( \frac{\partial f}{\partial x_k} \right) = \sum_{s=1}^n \frac{\partial^2 f}{\partial x_s \partial x_j} \frac{\partial x_s}{\partial u_k}.$$

Substituting this into (5.4.16) yields

$$\frac{\partial^2 h}{\partial u_k \partial u_i} = \sum_{j=1}^n \frac{\partial f}{\partial x_j} \frac{\partial^2 x_j}{\partial u_k \partial u_i} + \sum_{j=1}^n \frac{\partial x_j}{\partial u_i} \sum_{s=1}^n \frac{\partial^2 f}{\partial x_s \partial x_j} \frac{\partial x_s}{\partial u_k}.\quad (5.4.18)$$

To compute  $h_{u_i u_k}(\mathbf{U}_0)$  from this formula, we evaluate the partial derivatives of  $x_1, x_2, \dots, x_n$  at  $\mathbf{U}_0$  and those of  $f$  at  $\mathbf{X}_0 = \mathbf{X}(\mathbf{U}_0)$ . The formula is valid if  $x_1, x_2, \dots, x_n$  and their first partial derivatives are differentiable at  $\mathbf{U}_0$  and  $f, f_{x_1}, f_{x_2}, \dots, f_{x_n}$  and their first partial derivatives are differentiable at  $\mathbf{X}_0$ .

Instead of memorizing (5.4.18), you should understand how it is derived and use the method, rather than the formula, when calculating second partial derivatives of composite functions. The same method applies to the calculation of higher derivatives.

**Example 5.4.5** Suppose that  $f_x$  and  $f_y$  in Example 5.4.2 are differentiable on an open set  $S$  in  $\mathbb{R}^2$ . Differentiating (5.4.11) with respect to  $r$  yields

$$\begin{aligned}\frac{\partial^2 h}{\partial r^2} &= \cos \theta \frac{\partial}{\partial r} \left( \frac{\partial f}{\partial x} \right) + \sin \theta \frac{\partial}{\partial r} \left( \frac{\partial f}{\partial y} \right) \\ &= \cos \theta \left( \frac{\partial^2 f}{\partial x^2} \frac{\partial x}{\partial r} + \frac{\partial^2 f}{\partial y \partial x} \frac{\partial y}{\partial r} \right) + \sin \theta \left( \frac{\partial^2 f}{\partial x \partial y} \frac{\partial x}{\partial r} + \frac{\partial^2 f}{\partial y^2} \frac{\partial y}{\partial r} \right)\end{aligned}\tag{5.4.19}$$

if  $(x, y) \in S$ . Since

$$\frac{\partial x}{\partial r} = \cos \theta, \quad \frac{\partial y}{\partial r} = \sin \theta, \quad \text{and} \quad \frac{\partial^2 f}{\partial x \partial y} = \frac{\partial^2 f}{\partial y \partial x}$$

if  $(x, y) \in S$  (Exercise 5.3.21), (5.4.19) yields

$$\frac{\partial^2 h}{\partial r^2} = \cos^2 \theta \frac{\partial^2 f}{\partial x^2} + 2 \sin \theta \cos \theta \frac{\partial^2 f}{\partial x \partial y} + \sin^2 \theta \frac{\partial^2 f}{\partial y^2}.$$

Differentiating (5.4.11) with respect to  $\theta$  yields

$$\begin{aligned}\frac{\partial^2 h}{\partial \theta \partial r} &= -\sin \theta \frac{\partial f}{\partial x} + \cos \theta \frac{\partial f}{\partial y} + \cos \theta \frac{\partial}{\partial \theta} \left( \frac{\partial f}{\partial x} \right) + \sin \theta \frac{\partial}{\partial \theta} \left( \frac{\partial f}{\partial y} \right) \\ &= -\sin \theta \frac{\partial f}{\partial x} + \cos \theta \frac{\partial f}{\partial y} + \cos \theta \left( \frac{\partial^2 f}{\partial x^2} \frac{\partial x}{\partial \theta} + \frac{\partial^2 f}{\partial y \partial x} \frac{\partial y}{\partial \theta} \right) \\ &\quad + \sin \theta \left( \frac{\partial^2 f}{\partial x \partial y} \frac{\partial x}{\partial \theta} + \frac{\partial^2 f}{\partial y^2} \frac{\partial y}{\partial \theta} \right).\end{aligned}$$

Since

$$\frac{\partial x}{\partial \theta} = -r \sin \theta \quad \text{and} \quad \frac{\partial y}{\partial \theta} = r \cos \theta,$$

it follows that

$$\begin{aligned}\frac{\partial^2 h}{\partial \theta \partial r} &= -\sin \theta \frac{\partial f}{\partial x} + \cos \theta \frac{\partial f}{\partial y} - r \sin \theta \cos \theta \left( \frac{\partial^2 f}{\partial x^2} - \frac{\partial^2 f}{\partial y^2} \right) \\ &\quad + r(\cos^2 \theta - \sin^2 \theta) \frac{\partial^2 f}{\partial x \partial y}.\end{aligned}$$

## The Mean Value Theorem

For a composite function of the form

$$h(t) = f(x_1(t), x_2(t), \dots, x_n(t))$$

where  $t$  is a real variable,  $x_1, x_2, \dots, x_n$  are differentiable at  $t_0$ , and  $f$  is differentiable at  $\mathbf{X}_0 = \mathbf{X}(t_0)$ , (5.4.8) takes the form

$$h'(t_0) = \sum_{j=1}^n f_{x_j}(\mathbf{X}(t_0))x'_j(t_0).\tag{5.4.20}$$

This will be useful in the proof of the following theorem.

**Theorem 5.4.5 (Mean Value Theorem for Functions of  $n$  Variables)**

Let  $f$  be continuous at  $\mathbf{X}_1 = (x_{11}, x_{21}, \dots, x_{n1})$  and  $\mathbf{X}_2 = (x_{12}, x_{22}, \dots, x_{n2})$  and differentiable on the line segment  $L$  from  $\mathbf{X}_1$  to  $\mathbf{X}_2$ . Then

$$f(\mathbf{X}_2) - f(\mathbf{X}_1) = \sum_{i=1}^n f_{x_i}(\mathbf{X}_0)(x_{i2} - x_{i1}) = (d_{\mathbf{X}_0} f)(\mathbf{X}_2 - \mathbf{X}_1) \quad (5.4.21)$$

for some  $\mathbf{X}_0$  on  $L$  distinct from  $\mathbf{X}_1$  and  $\mathbf{X}_2$ .

**Proof** An equation of  $L$  is

$$\mathbf{X} = \mathbf{X}(t) = t\mathbf{X}_2 + (1-t)\mathbf{X}_1, \quad 0 \leq t \leq 1.$$

Our hypotheses imply that the function

$$h(t) = f(\mathbf{X}(t))$$

is continuous on  $[0, 1]$  and differentiable on  $(0, 1)$ . Since

$$x_i(t) = tx_{i2} + (1-t)x_{i1},$$

(5.4.20) implies that

$$h'(t) = \sum_{i=1}^n f_{x_i}(\mathbf{X}(t))(x_{i2} - x_{i1}), \quad 0 < t < 1.$$

From the mean value theorem for functions of one variable (Theorem 2.3.11),

$$h(1) - h(0) = h'(t_0)$$

for some  $t_0 \in (0, 1)$ . Since  $h(1) = f(\mathbf{X}_2)$  and  $h(0) = f(\mathbf{X}_1)$ , this implies (5.4.21) with  $\mathbf{X}_0 = \mathbf{X}(t_0)$ . ■

**Corollary 5.4.6** If  $f_{x_1}, f_{x_2}, \dots, f_{x_n}$  are identically zero in an open region  $S$  of  $\mathbb{R}^n$ , then  $f$  is constant in  $S$ .

**Proof** We will show that if  $\mathbf{X}_0$  and  $\mathbf{X}$  are in  $S$ , then  $f(\mathbf{X}) = f(\mathbf{X}_0)$ . Since  $S$  is an open region,  $S$  is polygonally connected (Theorem 5.1.20). Therefore, there are points

$$\mathbf{X}_0, \mathbf{X}_1, \dots, \mathbf{X}_n = \mathbf{X}$$

such that the line segment  $L_i$  from  $\mathbf{X}_{i-1}$  to  $\mathbf{X}_i$  is in  $S$ ,  $1 \leq i \leq n$ . From Theorem 5.4.5,

$$f(\mathbf{X}_i) - f(\mathbf{X}_{i-1}) = \sum_{i=1}^n (d_{\tilde{\mathbf{X}}_i} f)(\mathbf{X}_i - \mathbf{X}_{i-1}),$$

where  $\tilde{\mathbf{X}}$  is on  $L_i$  and therefore in  $S$ . Therefore,

$$f_{x_1}(\tilde{\mathbf{X}}_i) = f_{x_2}(\tilde{\mathbf{X}}_i) = \dots = f_{x_n}(\tilde{\mathbf{X}}_i) = 0,$$

which means that  $d_{\mathbf{X}_i} f \equiv 0$ . Hence,

$$f(\mathbf{X}_0) = f(\mathbf{X}_1) = \cdots = f(\mathbf{X}_n);$$

that is,  $f(\mathbf{X}) = f(\mathbf{X}_0)$  for every  $\mathbf{X}$  in  $S$ . ■

### Higher Differentials and Taylor's Theorem

Suppose that  $f$  is defined in an  $n$ -ball  $B_\rho(\mathbf{X}_0)$ , with  $\rho > 0$ . If  $\mathbf{X} \in B_\rho(\mathbf{X}_0)$ , then

$$\mathbf{X}(t) = \mathbf{X}_0 + t(\mathbf{X} - \mathbf{X}_0) \in B_\rho(\mathbf{X}), \quad 0 \leq t \leq 1,$$

so the function

$$h(t) = f(\mathbf{X}(t))$$

is defined for  $0 \leq t \leq 1$ . From Theorem 5.4.3 (see also (5.4.20)),

$$h'(t) = \sum_{i=1}^n f_{x_i}(\mathbf{X}(t))(x_i - x_{i0})$$

if  $f$  is differentiable in  $B_\rho(\mathbf{X}_0)$ , and

$$\begin{aligned} h''(t) &= \sum_{j=1}^n \frac{\partial}{\partial x_j} \left( \sum_{i=1}^n \frac{\partial f(\mathbf{X}(t))}{\partial x_i} (x_i - x_{i0}) \right) (x_j - x_{j0}) \\ &= \sum_{i,j=1}^n \frac{\partial^2 f(\mathbf{X}(t))}{\partial x_j \partial x_i} (x_i - x_{i0})(x_j - x_{j0}) \end{aligned}$$

if  $f_{x_1}, f_{x_2}, \dots, f_{x_n}$  are differentiable in  $B_\rho(\mathbf{X}_0)$ . Continuing in this way, we see that

$$h^{(r)}(t) = \sum_{i_1, i_2, \dots, i_r=1}^n \frac{\partial^r f(\mathbf{X}(t))}{\partial x_{i_r} \partial x_{i_{r-1}} \cdots \partial x_{i_1}} (x_{i_1} - x_{i_1,0})(x_{i_2} - x_{i_2,0}) \cdots (x_{i_r} - x_{i_r,0}) \quad (5.4.22)$$

if all partial derivatives of  $f$  of order  $\leq r - 1$  are differentiable in  $B_\rho(\mathbf{X}_0)$ .

This motivates the following definition.

**Definition 5.4.7** Suppose that  $r \geq 1$  and all partial derivatives of  $f$  of order  $\leq r - 1$  are differentiable in a neighborhood of  $\mathbf{X}_0$ . Then the  $r$ th differential of  $f$  at  $\mathbf{X}_0$ , denoted by  $d_{\mathbf{X}_0}^{(r)} f$ , is defined by

$$d_{\mathbf{X}_0}^{(r)} f = \sum_{i_1, i_2, \dots, i_r=1}^n \frac{\partial^r f(\mathbf{X}_0)}{\partial x_{i_r} \partial x_{i_{r-1}} \cdots \partial x_{i_1}} dx_{i_1} dx_{i_2} \cdots dx_{i_r}, \quad (5.4.23)$$

where  $dx_1, dx_2, \dots, dx_n$  are the differentials introduced in Section 5.3; that is,  $dx_i$  is the function whose value at a point in  $\mathbb{R}^n$  is the  $i$ th coordinate of the point. For convenience, we define

$$(d_{\mathbf{X}_0}^{(0)} f) = f(\mathbf{X}_0).$$

Notice that  $d_{\mathbf{X}_0}^{(1)} f = d_{\mathbf{X}_0} f$ . ■

Under the assumptions of Definition 5.4.7, the value of

$$\frac{\partial^r f(\mathbf{X}_0)}{\partial x_{i_r} \partial x_{i_{r-1}} \cdots \partial x_{i_1}}$$

depends only on the number of times  $f$  is differentiated with respect to each variable, and not on the order in which the differentiations are performed (Exercise 5.3.22). Hence, Exercise 5.3.12 implies that (5.4.23) can be rewritten as

$$d_{\mathbf{X}_0}^{(r)} f = \sum_r \frac{r!}{r_1! r_2! \cdots r_n!} \frac{\partial^r f(\mathbf{X}_0)}{\partial x_1^{r_1} \partial x_2^{r_2} \cdots \partial x_n^{r_n}} (dx_1)^{r_1} (dx_2)^{r_2} \cdots (dx_n)^{r_n}, \quad (5.4.24)$$

where  $\sum_r$  indicates summation over all ordered  $n$ -tuples  $(r_1, r_2, \dots, r_n)$  of nonnegative integers such that

$$r_1 + r_2 + \cdots + r_n = r$$

and  $\partial x_i^{r_i}$  is omitted from the “denominators” of all terms in (5.4.24) for which  $r_i = 0$ . In particular, if  $n = 2$ ,

$$d_{\mathbf{X}_0}^{(r)} f = \sum_{j=0}^r \binom{r}{j} \frac{\partial^r f(x_0, y_0)}{\partial x^j \partial y^{r-j}} (dx)^j (dy)^{r-j}.$$

**Example 5.4.6** Let

$$f(x, y) = \frac{1}{1 + ax + by},$$

where  $a$  and  $b$  are constants. Then

$$\frac{\partial^r f(x, y)}{\partial x^j \partial y^{r-j}} = (-1)^r r! \frac{a^j b^{r-j}}{(1 + ax + by)^{r+1}},$$

so

$$\begin{aligned} d_{\mathbf{X}_0}^{(r)} f &= \frac{(-1)^r r!}{(1 + ax_0 + by_0)^{r+1}} \sum_{j=0}^r \binom{r}{j} a^j b^{r-j} (dx)^j (dy)^{r-j} \\ &= \frac{(-1)^r r!}{(1 + ax_0 + by_0)^{r+1}} (a dx + b dy)^r \end{aligned}$$

if  $1 + ax_0 + by_0 \neq 0$ .

**Example 5.4.7** Let

$$f(\mathbf{X}) = \exp \left( - \sum_{j=1}^n a_j x_j \right),$$

where  $a_1, a_2, \dots, a_n$  are constants. Then

$$\frac{\partial^r f(\mathbf{X})}{\partial x_1^{r_1} \partial x_2^{r_2} \cdots \partial x_n^{r_n}} = (-1)^r a_1^{r_1} a_2^{r_2} \cdots a_n^{r_n} \exp \left( - \sum_{j=1}^n a_j x_j \right).$$

Therefore,

$$\begin{aligned} (d_{\mathbf{X}_0}^{(r)} f)(\Phi) &= (-1)^r \left( \sum_r \frac{r!}{r_1! r_2! \cdots r_n!} a_1^{r_1} a_2^{r_2} \cdots a_n^{r_n} (dx_1)^{r_1} (dx_2)^{r_2} \cdots (dx_n)^{r_n} \right) \\ &\quad \times \exp \left( - \sum_{j=1}^n a_j x_{j0} \right) \\ &= (-1)^r (a_1 dx_1 + a_2 dx_2 + \cdots + a_n dx_n)^r \exp \left( - \sum_{j=1}^n a_j x_{j0} \right) \end{aligned}$$

(Exercise 5.3.12). ■

The next theorem is analogous to Taylor's theorem for functions of one variable (Theorem 2.5.4).

**Theorem 5.4.8 (Taylor's Theorem for Functions of  $n$  Variables)** *Suppose that  $f$  and its partial derivatives of order  $\leq k$  are differentiable at  $\mathbf{X}_0$  and  $\mathbf{X}$  in  $\mathbb{R}^n$  and on the line segment  $L$  connecting them. Then*

$$f(\mathbf{X}) = \sum_{r=0}^k \frac{1}{r!} (d_{\mathbf{X}_0}^{(r)} f)(\mathbf{X} - \mathbf{X}_0) + \frac{1}{(k+1)!} (d_{\tilde{\mathbf{X}}}^{(k+1)} f)(\mathbf{X} - \mathbf{X}_0) \quad (5.4.25)$$

for some  $\tilde{\mathbf{X}}$  on  $L$  distinct from  $\mathbf{X}_0$  and  $\mathbf{X}$ .

**Proof** Define

$$h(t) = f(\mathbf{X}_0 + t(\mathbf{X} - \mathbf{X}_0)). \quad (5.4.26)$$

With  $\Phi = \mathbf{X} - \mathbf{X}_0$ , our assumptions and the discussion preceding Definition 5.4.7 imply that  $h, h', \dots, h^{(k+1)}$  exist on  $[0, 1]$ . From Taylor's theorem for functions of one variable,

$$h(1) = \sum_{r=0}^k \frac{h^{(r)}(0)}{r!} + \frac{h^{(k+1)}(\tau)}{(k+1)!}, \quad (5.4.27)$$

for some  $\tau \in (0, 1)$ . From (5.4.26),

$$h(0) = f(\mathbf{X}_0) \quad \text{and} \quad h(1) = f(\mathbf{X}). \quad (5.4.28)$$

From (5.4.22) and (5.4.23) with  $\Phi = \mathbf{X} - \mathbf{X}_0$ ,

$$h^{(r)}(0) = (d_{\mathbf{X}_0}^{(r)} f)(\mathbf{X} - \mathbf{X}_0), \quad 1 \leq r \leq k, \quad (5.4.29)$$

and

$$h^{(k+1)}(\tau) = \left( d_{\tilde{\mathbf{X}}}^{(k+1)} f \right) (\mathbf{X} - \mathbf{X}_0) \quad (5.4.30)$$

where

$$\tilde{\mathbf{X}} = \mathbf{X}_0 + \tau(\mathbf{X} - \mathbf{X}_0)$$

is on  $L$  and distinct from  $\mathbf{X}_0$  and  $\mathbf{X}$ . Substituting (5.4.28), (5.4.29), and (5.4.30) into (5.4.27) yields (5.4.25). ■

**Example 5.4.8** Theorem 5.4.8 and the results of Example 5.4.6 with  $\mathbf{X}_0 = (0, 0)$  and  $\Phi = (x, y)$  imply that if  $1 + ax + by > 0$ , then

$$\frac{1}{1 + ax + by} = \sum_{r=0}^k (-1)^r (ax + by)^r + (-1)^{k+1} \frac{(ax + by)^{k+1}}{(1 + a\tau x + b\tau y)^{k+2}}$$

for some  $\tau \in (0, 1)$ . (Note that  $\tau$  depends on  $k$  as well as  $(x, y)$ .)

**Example 5.4.9** Theorem 5.4.8 and the results of Example 5.4.7 with  $\mathbf{X}_0 = \mathbf{0}$  and  $\Phi = \mathbf{X}$  imply that

$$\begin{aligned} \exp\left(-\sum_{j=1}^n a_j x_j\right) &= \sum_{r=0}^k \frac{(-1)^r}{r!} (a_1 x_1 + a_2 x_2 + \cdots + a_n x_n)^r \\ &\quad + \frac{(-1)^{k+1}}{(k+1)!} (a_1 x_1 + a_2 x_2 + \cdots + a_n x_n)^{k+1} \\ &\quad \times \exp\left[-\tau \left(\sum_{j=1}^n a_j x_j\right)\right], \end{aligned}$$

for some  $\tau \in (0, 1)$ . ■

By analogy with the situation for functions of one variable, we define the  $k$ th Taylor polynomial of  $f$  about  $\mathbf{X}_0$  by

$$T_k(\mathbf{X}) = \sum_{r=0}^k \frac{1}{r!} (d_{\mathbf{X}_0}^{(r)} f)(\mathbf{X} - \mathbf{X}_0)$$

if the differentials exist; then (5.4.25) can be rewritten as

$$f(\mathbf{X}) = T_k(\mathbf{X}) + \frac{1}{(k+1)!} (d_{\tilde{\mathbf{X}}}^{(k+1)} f)(\mathbf{X} - \mathbf{X}_0).$$

## A Sufficient Condition for Relative Extreme Values

The next theorem leads to a useful sufficient condition for local maxima and minima. It is related to Theorem 2.5.1. Strictly speaking, however, it is not a generalization of Theorem 2.5.1 (Exercise 5.4.18).



**Theorem 5.4.9** Suppose that  $f$  and its partial derivatives of order  $\leq k-1$  are differentiable in a neighborhood  $N$  of a point  $\mathbf{X}_0$  in  $\mathbb{R}^n$  and all  $k$ th-order partial derivatives of  $f$  are continuous at  $\mathbf{X}_0$ . Then

$$\lim_{\mathbf{X} \rightarrow \mathbf{X}_0} \frac{f(\mathbf{X}) - T_k(\mathbf{X})}{|\mathbf{X} - \mathbf{X}_0|^k} = 0. \quad (5.4.31)$$

**Proof** If  $\epsilon > 0$ , there is a  $\delta > 0$  such that  $B_\delta(\mathbf{X}_0) \subset N$  and all  $k$ th-order partial derivatives of  $f$  satisfy the inequality

$$\left| \frac{\partial^k f(\tilde{\mathbf{X}})}{\partial x_{i_k} \partial x_{i_{k-1}} \cdots \partial x_{i_1}} - \frac{\partial^k f(\mathbf{X}_0)}{\partial x_{i_k} \partial x_{i_{k-1}} \cdots \partial x_{i_1}} \right| < \epsilon, \quad \tilde{\mathbf{X}} \in B_\delta(\mathbf{X}_0). \quad (5.4.32)$$

Now suppose that  $\mathbf{X} \in B_\delta(\mathbf{X}_0)$ . From Theorem 5.4.8 with  $k$  replaced by  $k-1$ ,

$$f(\mathbf{X}) = T_{k-1}(\mathbf{X}) + \frac{1}{k!} (d_{\tilde{\mathbf{X}}}^{(k)} f)(\mathbf{X} - \mathbf{X}_0), \quad (5.4.33)$$

where  $\tilde{\mathbf{X}}$  is some point on the line segment from  $\mathbf{X}_0$  to  $\mathbf{X}$  and is therefore in  $B_\delta(\mathbf{X}_0)$ . We can rewrite (5.4.33) as

$$f(\mathbf{X}) = T_k(\mathbf{X}) + \frac{1}{k!} \left[ (d_{\tilde{\mathbf{X}}}^{(k)} f)(\mathbf{X} - \mathbf{X}_0) - (d_{\mathbf{X}_0}^{(k)} f)(\mathbf{X} - \mathbf{X}_0) \right]. \quad (5.4.34)$$

But (5.4.23) and (5.4.32) imply that

$$\left| (d_{\tilde{\mathbf{X}}}^{(k)} f)(\mathbf{X} - \mathbf{X}_0) - (d_{\mathbf{X}_0}^{(k)} f)(\mathbf{X} - \mathbf{X}_0) \right| < n^k \epsilon |\mathbf{X} - \mathbf{X}_0|^k \quad (5.4.35)$$

(Exercise 5.4.17), which implies that

$$\frac{|f(\mathbf{X}) - T_k(\mathbf{X})|}{|\mathbf{X} - \mathbf{X}_0|^k} < \frac{n^k \epsilon}{k!}, \quad \mathbf{X} \in B_\delta(\mathbf{X}_0),$$

from (5.4.34). This implies (5.4.31).  $\blacksquare$

Let  $r$  be a positive integer and  $\mathbf{X}_0 = (x_{10}, x_{20}, \dots, x_{n0})$ . A function of the form

$$p(\mathbf{X}) = \sum_r a_{r_1 r_2 \dots r_n} (x_1 - x_{10})^{r_1} (x_2 - x_{20})^{r_2} \cdots (x_n - x_{n0})^{r_n}, \quad (5.4.36)$$

where the coefficients  $\{a_{r_1 r_2 \dots r_n}\}$  are constants and the summation is over all  $n$ -tuples of nonnegative integers  $(r_1, r_2, \dots, r_n)$  such that

$$r_1 + r_2 + \cdots + r_n = r,$$

is a *homogeneous polynomial of degree  $r$*  in  $\mathbf{X} - \mathbf{X}_0$ , provided that at least one of the coefficients is nonzero. For example, if  $f$  satisfies the conditions of Definition 5.4.7, then the function

$$p(\mathbf{X}) = (d_{\mathbf{X}_0}^{(r)} f)(\mathbf{X} - \mathbf{X}_0)$$

is such a polynomial if at least one of the  $r$ th-order mixed partial derivatives of  $f$  at  $\mathbf{X}_0$  is nonzero.

Clearly,  $p(\mathbf{X}_0) = 0$  if  $p$  is a homogeneous polynomial of degree  $r \geq 1$  in  $\mathbf{X} - \mathbf{X}_0$ . If  $p(\mathbf{X}) \geq 0$  for all  $\mathbf{X}$ , we say that  $p$  is *positive semidefinite*; if  $p(\mathbf{X}) > 0$  except when  $\mathbf{X} = \mathbf{X}_0$ ,  $p$  is *positive definite*.

Similarly,  $p$  is *negative semidefinite* if  $p(\mathbf{X}) \leq 0$  or *negative definite* if  $p(\mathbf{X}) < 0$  for all  $\mathbf{X} \neq \mathbf{X}_0$ . In all these cases,  $p$  is *semidefinite*.

With  $p$  as in (5.4.36),

$$p(-\mathbf{X} + 2\mathbf{X}_0) = (-1)^r p(\mathbf{X}),$$

so  $p$  cannot be semidefinite if  $r$  is odd.

**Example 5.4.10** The polynomial

$$p(x, y, z) = x^2 + y^2 + z^2 + xy + xz + yz$$

is homogeneous of degree 2 in  $\mathbf{X} = (x, y, z)$ . We can rewrite  $p$  as

$$p(x, y, z) = \frac{1}{2} [(x + y)^2 + (y + z)^2 + (z + x)^2],$$

so  $p$  is nonnegative, and  $p(\bar{x}, \bar{y}, \bar{z}) = 0$  if and only if

$$\bar{x} + \bar{y} = \bar{y} + \bar{z} = \bar{z} + \bar{x} = 0,$$

which is equivalent to  $(\bar{x}, \bar{y}, \bar{z}) = (0, 0, 0)$ . Therefore,  $p$  is positive definite and  $-p$  is negative definite.

The polynomial

$$p_1(x, y, z) = x^2 + y^2 + z^2 + 2xy$$

can be rewritten as

$$p_1(x, y, z) = (x + y)^2 + z^2,$$

so  $p_1$  is nonnegative. Since  $p_1(1, -1, 0) = 0$ ,  $p_1$  is positive semidefinite and  $-p_1$  is negative semidefinite.

The polynomial

$$p_2(x, y, z) = x^2 - y^2 + z^2$$

is not semidefinite, since, for example,

$$p_2(1, 0, 0) = 1 \quad \text{and} \quad p_2(0, 1, 0) = -1. \quad \blacksquare$$

From Theorem 5.3.11, if  $f$  is differentiable and attains a local extreme value at  $\mathbf{X}_0$ , then

$$d_{\mathbf{X}_0} f = 0, \tag{5.4.37}$$

since  $f_{x_1}(\mathbf{X}_0) = f_{x_2}(\mathbf{X}_0) = \cdots = f_{x_n}(\mathbf{X}_0) = 0$ . However, the converse is false. The next theorem provides a method for deciding whether a point satisfying (5.4.37) is an extreme point. It is related to Theorem 2.5.3.

**Theorem 5.4.10** Suppose that  $f$  satisfies the hypotheses of Theorem 5.4.9 with  $k \geq 2$ , and

$$d_{\mathbf{X}_0}^{(r)} f \equiv 0 \quad (1 \leq r \leq k-1), \quad d_{\mathbf{X}_0}^{(k)} f \neq 0. \quad (5.4.38)$$

Then

- (a)  $\mathbf{X}_0$  is not a local extreme point of  $f$  unless  $d_{\mathbf{X}_0}^{(k)} f$  is semidefinite as a polynomial in  $\mathbf{X} - \mathbf{X}_0$ . In particular,  $\mathbf{X}_0$  is not a local extreme point of  $f$  if  $k$  is odd.
- (b)  $\mathbf{X}_0$  is a local minimum point of  $f$  if  $d_{\mathbf{X}_0}^{(k)} f$  is positive definite, or a local maximum point if  $d_{\mathbf{X}_0}^{(k)} f$  is negative definite.
- (c) If  $d_{\mathbf{X}_0}^{(k)} f$  is semidefinite, then  $\mathbf{X}_0$  may be a local extreme point of  $f$ , but it need not be.

**Proof** From (5.4.38) and Theorem 5.4.9,

$$\lim_{\mathbf{X} \rightarrow \mathbf{X}_0} \frac{f(\mathbf{X}) - f(\mathbf{X}_0) - \frac{1}{k!} (d_{\mathbf{X}_0}^{(k)} f)(\mathbf{X} - \mathbf{X}_0)}{|\mathbf{X} - \mathbf{X}_0|^k} = 0. \quad (5.4.39)$$

If  $\mathbf{X} = \mathbf{X}_0 + t\mathbf{U}$ , where  $\mathbf{U}$  is a constant vector, then

$$(d_{\mathbf{X}_0}^{(k)} f)(\mathbf{X} - \mathbf{X}_0) = t^k (d_{\mathbf{X}_0}^{(k)} f)(\mathbf{U}),$$

so (5.4.39) implies that

$$\lim_{t \rightarrow 0} \frac{f(\mathbf{X}_0 + t\mathbf{U}) - f(\mathbf{X}_0) - \frac{t^k}{k!} (d_{\mathbf{X}_0}^{(k)} f)(\mathbf{U})}{t^k} = 0,$$

or, equivalently,

$$\lim_{t \rightarrow 0} \frac{f(\mathbf{X}_0 + t\mathbf{U}) - f(\mathbf{X}_0)}{t^k} = \frac{1}{k!} (d_{\mathbf{X}_0}^{(k)} f)(\mathbf{U}) \quad (5.4.40)$$

for any constant vector  $\mathbf{U}$ .

To prove (a), suppose that  $d_{\mathbf{X}_0}^{(k)} f$  is not semidefinite. Then there are vectors  $\mathbf{U}_1$  and  $\mathbf{U}_2$  such that

$$(d_{\mathbf{X}_0}^{(k)} f)(\mathbf{U}_1) > 0 \quad \text{and} \quad (d_{\mathbf{X}_0}^{(k)} f)(\mathbf{U}_2) < 0.$$

This and (5.4.40) imply that

$$f(\mathbf{X}_0 + t\mathbf{U}_1) > f(\mathbf{X}_0) \quad \text{and} \quad f(\mathbf{X}_0 + t\mathbf{U}_2) < f(\mathbf{X}_0)$$

for  $t$  sufficiently small. Hence,  $\mathbf{X}_0$  is not a local extreme point of  $f$ .

To prove (b), first assume that  $d_{\mathbf{X}_0}^{(k)} f$  is positive definite. Then it can be shown that there is a  $\rho > 0$  such that

$$\frac{(d_{\mathbf{X}_0}^{(k)} f)(\mathbf{X} - \mathbf{X}_0)}{k!} \geq \rho |\mathbf{X} - \mathbf{X}_0|^k \quad (5.4.41)$$

for all  $\mathbf{X}$  (Exercise 5.4.19). From (5.4.39), there is a  $\delta > 0$  such that

$$\frac{f(\mathbf{X}) - f(\mathbf{X}_0) - \frac{1}{k!}(d_{\mathbf{X}_0}^{(k)}f)(\mathbf{X} - \mathbf{X}_0)}{|\mathbf{X} - \mathbf{X}_0|^k} > -\frac{\rho}{2} \quad \text{if } |\mathbf{X} - \mathbf{X}_0| < \delta.$$

Therefore,

$$f(\mathbf{X}) - f(\mathbf{X}_0) > \frac{1}{k!}(d_{\mathbf{X}_0}^{(k)}f)(\mathbf{X} - \mathbf{X}_0) - \frac{\rho}{2}|\mathbf{X} - \mathbf{X}_0|^k \quad \text{if } |\mathbf{X} - \mathbf{X}_0| < \delta.$$

This and (5.4.41) imply that

$$f(\mathbf{X}) - f(\mathbf{X}_0) > \frac{\rho}{2}|\mathbf{X} - \mathbf{X}_0|^k \quad \text{if } |\mathbf{X} - \mathbf{X}_0| < \delta,$$

which implies that  $\mathbf{X}_0$  is a local minimum point of  $f$ . This proves half of (b). We leave the other half to you (Exercise 5.4.20).

To prove (c) merely requires examples; see Exercise 5.4.21. ■

**Corollary 5.4.11** *Suppose that  $f$ ,  $f_x$ , and  $f_y$  are differentiable in a neighborhood of a critical point  $\mathbf{X}_0 = (x_0, y_0)$  of  $f$  and  $f_{xx}$ ,  $f_{yy}$ , and  $f_{xy}$  are continuous at  $(x_0, y_0)$ . Let*

$$D = f_{xx}(x_0, y_0)f_{yy}(x_0, y_0) - f_{xy}^2(x_0, y_0).$$

Then

- (a)  $(x_0, y_0)$  is a local extreme point of  $f$  if  $D > 0$ ;  $(x_0, y_0)$  is a local minimum point if  $f_{xx}(x_0, y_0) > 0$ , or a local maximum point if  $f_{xx}(x_0, y_0) < 0$ .  
 (b)  $(x_0, y_0)$  is not a local extreme point of  $f$  if  $D < 0$ .

**Proof** Write  $(x - x_0, y - y_0) = (u, v)$  and

$$p(u, v) = (d_{\mathbf{X}_0}^{(2)}f)(u, v) = Au^2 + 2Buv + Cv^2,$$

where  $A = f_{xx}(x_0, y_0)$ ,  $B = f_{xy}(x_0, y_0)$ , and  $C = f_{yy}(x_0, y_0)$ , so

$$D = AC - B^2.$$

If  $D > 0$ , then  $A \neq 0$ , and we can write

$$\begin{aligned} p(u, v) &= A \left( u^2 + \frac{2B}{A}uv + \frac{B^2}{A^2}v^2 \right) + \left( C - \frac{B^2}{A} \right) v^2 \\ &= A \left( u + \frac{B}{A}v \right)^2 + \frac{D}{A}v^2. \end{aligned}$$

This cannot vanish unless  $u = v = 0$ . Hence,  $d_{\mathbf{X}_0}^{(2)}f$  is positive definite if  $A > 0$  or negative definite if  $A < 0$ , and Theorem 5.4.10(b) implies (a).

If  $D < 0$ , there are three possibilities:

1.  $A \neq 0$ ; then  $p(1, 0) = A$  and  $p\left(-\frac{B}{A}, 1\right) = \frac{D}{A}$ .
2.  $C \neq 0$ ; then  $p(0, 1) = C$  and  $p\left(1, -\frac{B}{C}\right) = \frac{D}{C}$ .
3.  $A = C = 0$ ; then  $B \neq 0$  and  $p(1, 1) = 2B$  and  $p(1, -1) = -2B$ .

In each case the two given values of  $p$  differ in sign, so  $\mathbf{X}_0$  is not a local extreme point of  $f$ , from Theorem 5.4.10(a). ■

**Example 5.4.11** If

$$f(x, y) = e^{ax^2+by^2},$$

then

$$f_x(x, y) = 2axf(x, y), \quad f_y(x, y) = 2byf(x, y),$$

so

$$f_x(0, 0) = f_y(0, 0) = 0,$$

and  $(0, 0)$  is a critical point of  $f$ . To apply Corollary 5.4.11, we calculate

$$f_{xx}(x, y) = (2a + 4a^2x^2)f(x, y),$$

$$f_{yy}(x, y) = (2b + 4b^2y^2)f(x, y),$$

$$f_{xy}(x, y) = 4abxyf(x, y).$$

Therefore,

$$D = f_{xx}(0, 0)f_{yy}(0, 0) - f_{xy}^2(0, 0) = (2a)(2b) - (0)(0) = 4ab.$$

Corollary 5.4.11 implies that  $(0, 0)$  is a local minimum point if  $a$  and  $b$  are positive, a local maximum if  $a$  and  $b$  are negative, and neither if one is positive and the other is negative. Corollary 5.4.11 does not apply if  $a$  or  $b$  is zero.

## 5.4 Exercises

*In the exercises on the use of the chain rule, assume that the functions satisfy appropriate differentiability conditions.*

1. Under the assumptions of Theorem 5.4.3, show that  $\mathbf{U}_0$  is an interior point of the domain of  $h$ .

2. Let  $h(\mathbf{U}) = f(\mathbf{G}(\mathbf{U}))$  and find  $d_{\mathbf{U}_0}h$  by Theorem 5.4.3, and then by writing  $h$  explicitly as a function of  $\mathbf{U}$ .

$$\begin{aligned} \text{(a)} \quad f(x, y) &= 3x^2 + 4xy^2 + 3x, \\ g_1(u, v) &= ve^{u+v-1}, \\ g_2(u, v) &= e^{-u+v-1}, \end{aligned} \quad (u_0, v_0) = (0, 1)$$

$$\begin{aligned} \text{(b)} \quad f(x, y, z) &= e^{-(x+y+z)}, \\ g_1(u, v, w) &= \log u - \log v + \log w, \\ g_2(u, v, w) &= -2 \log u - 3 \log w, \\ g_3(u, v, w) &= \log u + \log v + 2 \log w, \end{aligned} \quad (u_0, v_0, w_0) = (1, 1, 1)$$

$$\begin{aligned} \text{(c)} \quad f(x, y) &= (x + y)^2, \\ g_1(u, v) &= u \cos v, \\ g_2(u, v) &= u \sin v, \end{aligned} \quad (u_0, v_0) = (3, \pi/2)$$

$$\begin{aligned} \text{(d)} \quad f(x, y, z) &= x^2 + y^2 + z^2, \\ g_1(u, v, w) &= u \cos v \sin w, \\ g_2(u, v, w) &= u \cos v \cos w, \\ g_3(u, v, w) &= u \sin v; \end{aligned} \quad (u_0, v_0, w_0) = (4, \pi/3, \pi/6)$$

3. Let  $h(r, \theta, z) = f(x, y, z)$ , where  $x = r \cos \theta$  and  $y = r \sin \theta$ . Find  $h_r$ ,  $h_\theta$ , and  $h_z$  in terms of  $f_x$ ,  $f_y$ , and  $f_z$ .
4. Let  $h(r, \theta, \phi) = f(x, y, z)$ , where  $x = r \sin \phi \cos \theta$ ,  $y = r \sin \phi \sin \theta$ , and  $z = r \cos \phi$ . Find  $h_r$ ,  $h_\theta$ , and  $h_\phi$  in terms of  $f_x$ ,  $f_y$ , and  $f_z$ .
5. Prove:

$$\text{(a)} \quad \text{If } h(u, v) = f(u^2 + v^2), \text{ then } vh_u - uh_v = 0.$$

$$\text{(b)} \quad \text{If } h(u, v) = f(\sin u + \cos v), \text{ then } h_u \sin v + h_v \cos u = 0.$$

$$\text{(c)} \quad \text{If } h(u, v) = f(u/v), \text{ then } uh_u + vh_v = 0.$$

$$\text{(d)} \quad \text{If } h(u, v) = f(g(u, v), -g(u, v)), \text{ then } dh = (f_x - f_y) dg.$$

6. Find  $h_y$  and  $h_z$  if

$$h(y, z) = g(x(y, z), y, z, w(y, z)).$$

7. Suppose that  $u$ ,  $v$ , and  $f$  are defined on  $(-\infty, \infty)$ . Let  $u$  and  $v$  be differentiable and  $f$  be continuous for all  $x$ . Show that

$$\frac{d}{dx} \int_{u(x)}^{v(x)} f(t) dt = f(v(x))v'(x) - f(u(x))u'(x).$$

8. We say that  $f = f(x_1, x_2, \dots, x_n)$  is *homogeneous of degree  $r$*  if  $D_f$  is open and there is a constant  $r$  such that

$$f(tx_1, tx_2, \dots, tx_n) = t^r f(x_1, x_2, \dots, x_n)$$

whenever  $t > 0$  and  $(x_1, x_2, \dots, x_n)$  and  $(tx_1, tx_2, \dots, tx_n)$  are in  $D_f$ . Prove: If  $f$  is differentiable and homogeneous of degree  $r$ , then

$$\sum_{i=1}^n x_i f_{x_i}(x_1, x_2, \dots, x_n) = r f(x_1, x_2, \dots, x_n).$$

(This is Euler's theorem for homogeneous functions.)

9. If  $h(r, \theta) = f(r \cos \theta, r \sin \theta)$ , show that

$$f_{xx} + f_{yy} = h_{rr} + \frac{1}{r} h_r + \frac{1}{r^2} h_{\theta\theta}.$$

HINT: Rewrite the defining equation as  $f(x, y) = h(r(x, y), \theta(x, y))$ , with  $r(x, y) = \sqrt{x^2 + y^2}$  and  $\theta(x, y) = \tan^{-1}(y/x)$ , and differentiate with respect to  $x$  and  $y$ .

10. Let  $h(u, v) = f(a(u, v), b(u, v))$ , where  $a_u = b_v$  and  $a_v = -b_u$ . Show that

$$h_{uu} + h_{vv} = (f_{xx} + f_{yy})(a_u^2 + a_v^2).$$

11. Prove: If

$$u(x, t) = f(x - ct) + g(x + ct),$$

then  $u_{tt} = c^2 u_{xx}$ .

12. Let  $h(u, v) = f(u + v, u - v)$ . Show that

$$(a) f_{xx} - f_{yy} = h_{uv} \quad (b) f_{xx} + f_{yy} = \frac{1}{2}(h_{uu} + h_{vv})$$

13. Returning to Exercise 5.4.4, find  $h_{rr}$  and  $h_{r\theta}$  in terms of the partial derivatives of  $f$ .

14. Let  $h_{uv} = 0$  for all  $(u, v)$ . Show that  $h$  is of the form

$$h(u, v) = U(u) + V(v).$$

Use this and Exercise 5.4.12(a) to show that if  $f_{xx} - f_{yy} = 0$  for all  $(x, y)$ , then

$$f(x, y) = U(x + y) + V(x - y).$$

15. Prove or give a counterexample: If  $f$  is differentiable and  $f_x = 0$  in a region  $D$ , then  $f(x_1, y) = f(x_2, y)$  whenever  $(x_1, y)$  and  $(x_2, y)$  are in  $D$ ; that is  $f(x, y)$  depends only on  $y$ .

16. Find  $T_3(\mathbf{X})$ .

- (a)  $f(x, y) = e^x \cos y$ ,  $\mathbf{X}_0 = (0, 0)$   
 (b)  $f(x, y) = e^{-x-y}$ ,  $\mathbf{X}_0 = (0, 0)$   
 (c)  $f(x, y, z) = (x + y + z - 3)^5$ ,  $\mathbf{X}_0 = (1, 1, 1)$   
 (d)  $f(x, y, z) = \sin x \sin y \sin z$ ,  $\mathbf{X}_0 = (0, 0, 0)$

17. Use Eqns. (5.4.23) and (5.4.32) to prove Eqn. (5.4.35).

18. Carefully explain why Theorem 5.4.9 is not a generalization of Theorem 2.5.1.
19. Suppose that  $p$  is a homogeneous polynomial of degree  $r$  in  $\mathbf{Y}$  and  $p(\mathbf{Y}) > 0$  for all nonzero  $\mathbf{Y}$  in  $\mathbb{R}^n$ . Show that there is a  $\rho > 0$  such that  $p(\mathbf{Y}) \geq \rho|\mathbf{Y}|^r$  for all  $\mathbf{Y}$  in  $\mathbb{R}^n$ . HINT:  $p$  assumes a minimum on the set  $\{\mathbf{Y} \mid |\mathbf{Y}| = 1\}$ . Use this to establish the inequality in Eqn. (5.4.41).
20. Complete the proof of Theorem 5.4.10(b).
21. (a) Show that  $(0, 0)$  is a critical point of each of the following functions, and that they have positive semidefinite second differentials at  $(0, 0)$ .

$$p(x, y) = x^2 - 2xy + y^2 + x^4 + y^4;$$

$$q(x, y) = x^2 - 2xy + y^2 - x^4 - y^4.$$

- (b) Show that  $D$  as defined in Corollary 5.4.11 is zero for both  $p$  and  $q$ .
- (c) Show that  $(0, 0)$  is a local minimum point of  $p$  but not a local extreme point of  $q$ .
22. Suppose that  $p = p(x_1, x_2, \dots, x_n)$  is a homogeneous polynomial of degree  $r$  (Exercise 5.4.8). Let  $i_1, i_2, \dots, i_n$  be nonnegative integers such that

$$i_1 + i_2 + \dots + i_n = k,$$

and let

$$q(x_1, x_2, \dots, x_n) = \frac{\partial^k p(x_1, x_2, \dots, x_n)}{\partial x_1^{i_1} \partial x_2^{i_2} \dots \partial x_n^{i_n}}.$$

Show that  $q$  is homogeneous of degree  $\leq r - k$ , subject to the convention that a homogeneous polynomial of negative degree is identically zero.

23. Suppose that  $f = f(x_1, x_2, \dots, x_n)$  is a homogeneous function of degree  $r$  (Exercise 8), with mixed partial derivative of all orders. Show that

$$\sum_{i,j=1}^n x_i x_j \frac{\partial^2 f(x_1, x_2, \dots, x_n)}{\partial x_i \partial x_j} = r(r-1)f(x_1, x_2, \dots, x_n)$$

and

$$\sum_{i,j,k=1}^n x_i x_j x_k \frac{\partial^3 f(x_1, x_2, \dots, x_n)}{\partial x_i \partial x_j \partial x_k} = r(r-1)(r-2)f(x_1, x_2, \dots, x_n).$$

Can you generalize these results?

24. Obtain the result in Example 5.4.7 by writing

$$F(\mathbf{X}) = e^{-a_1 x_1} e^{-a_2 x_2} \dots e^{-a_n x_n},$$

formally multiplying the series

$$e^{-a_i x_i} = \sum_{r_i=0}^{\infty} (-1)^{r_i} \frac{(a_i x_i)^{r_i}}{r_i!}, \quad 1 \leq i \leq n$$

together, and collecting the resulting products appropriately.



25. Let

$$f(x, y) = e^{x+y}.$$

By writing

$$f(x, y) = \sum_{r=0}^{\infty} \frac{(x+y)^r}{r!},$$

and expanding  $(x+y)^r$  by means of the binomial theorem, verify that

$$d_{(0,0)}^{(r)} f = \sum_{j=0}^r \binom{r}{j} \frac{\partial^r f(0,0)}{\partial x^j \partial y^{r-j}} (dx)^j (dy)^{r-j}.$$

## CHAPTER 6

### Vector-Valued Functions of Several Variables

IN THIS CHAPTER we study the differential calculus of vector-valued functions of several variables.

SECTION 6.1 reviews matrices, determinants, and linear transformations, which are integral parts of the differential calculus as presented here.

SECTION 6.2 defines continuity and differentiability of vector-valued functions of several variables. The differential of a vector-valued function  $\mathbf{F}$  is defined as a certain linear transformation. The matrix of this linear transformation is called the differential matrix of  $\mathbf{F}$ , denoted by  $\mathbf{F}'$ . The chain rule is extended to compositions of differentiable vector-valued functions.

SECTION 6.3 presents a complete proof of the inverse function theorem.

SECTION 6.4. uses the inverse function theorem to prove the implicit function theorem.

#### 6.1 LINEAR TRANSFORMATIONS AND MATRICES

In this and subsequent sections it will often be convenient to write vectors vertically; thus, instead of  $\mathbf{X} = (x_1, x_2, \dots, x_n)$  we will write

$$\mathbf{X} = \begin{bmatrix} x_1 \\ x_2 \\ \vdots \\ x_n \end{bmatrix}$$

when dealing with matrix operations. Although we assume that you have completed a course in linear algebra, we will review the pertinent matrix operations.

We have defined vector-valued functions as ordered  $n$ -tuples of real-valued functions, in connection with composite functions  $h = f \circ \mathbf{G}$ , where  $f$  is real-valued and  $\mathbf{G}$  is vector-valued. We now consider vector-valued functions as objects of interest on their own.

If  $f_1, f_2, \dots, f_m$  are real-valued functions defined on a set  $D$  in  $\mathbb{R}^n$ , then

$$\mathbf{F} = \begin{bmatrix} f_1 \\ f_2 \\ \vdots \\ f_m \end{bmatrix}$$

assigns to every  $\mathbf{X}$  in  $D$  an  $m$ -vector

$$\mathbf{F}(\mathbf{X}) = \begin{bmatrix} f_1(\mathbf{X}) \\ f_2(\mathbf{X}) \\ \vdots \\ f_m(\mathbf{X}) \end{bmatrix}.$$

Recall that  $f_1, f_2, \dots, f_m$  are the *component functions*, or simply *components*, of  $\mathbf{F}$ . We write

$$\mathbf{F} : \mathbb{R}^n \rightarrow \mathbb{R}^m$$

to indicate that the domain of  $\mathbf{F}$  is in  $\mathbb{R}^n$  and the range of  $\mathbf{F}$  is in  $\mathbb{R}^m$ . We also say that  $\mathbf{F}$  is a *transformation from  $\mathbb{R}^n$  to  $\mathbb{R}^m$* . If  $m = 1$ , we identify  $\mathbf{F}$  with its single component function  $f_1$  and regard it as a real-valued function.

**Example 6.1.1** The transformation  $\mathbf{F} : \mathbb{R}^2 \rightarrow \mathbb{R}^3$  defined by

$$\mathbf{F}(x, y) = \begin{bmatrix} 2x + 3y \\ -x + 4y \\ x - y \end{bmatrix}$$

has component functions

$$f_1(x, y) = 2x + 3y, \quad f_2(x, y) = -x + 4y, \quad f_3(x, y) = x - y.$$

## Linear Transformations

The simplest interesting transformations from  $\mathbb{R}^n$  to  $\mathbb{R}^m$  are the *linear transformations*, defined as follows

**Definition 6.1.1** A transformation  $\mathbf{L} : \mathbb{R}^n \rightarrow \mathbb{R}^m$  defined on all of  $\mathbb{R}^n$  is *linear* if

$$\mathbf{L}(\mathbf{X} + \mathbf{Y}) = \mathbf{L}(\mathbf{X}) + \mathbf{L}(\mathbf{Y})$$

for all  $\mathbf{X}$  and  $\mathbf{Y}$  in  $\mathbb{R}^n$  and

$$\mathbf{L}(a\mathbf{X}) = a\mathbf{L}(\mathbf{X})$$

for all  $\mathbf{X}$  in  $\mathbb{R}^n$  and real numbers  $a$ .

**Theorem 6.1.2** A transformation  $\mathbf{L} : \mathbb{R}^n \rightarrow \mathbb{R}^m$  defined on all of  $\mathbb{R}^n$  is linear if and only if

$$\mathbf{L}(\mathbf{X}) = \begin{bmatrix} a_{11}x_1 + a_{12}x_2 + \cdots + a_{1n}x_n \\ a_{21}x_1 + a_{22}x_2 + \cdots + a_{2n}x_n \\ \vdots \\ a_{m1}x_1 + a_{m2}x_2 + \cdots + a_{mn}x_n \end{bmatrix}, \quad (6.1.1)$$

where the  $a_{ij}$ 's are constants.

**Proof** It can be seen by induction (Exercise 6.1.1) that if  $\mathbf{L}$  is linear, then

$$\mathbf{L}(a_1\mathbf{X}_1 + a_2\mathbf{X}_2 + \cdots + a_k\mathbf{X}_k) = a_1\mathbf{L}(\mathbf{X}_1) + a_2\mathbf{L}(\mathbf{X}_2) + \cdots + a_k\mathbf{L}(\mathbf{X}_k) \quad (6.1.2)$$

for any vectors  $\mathbf{X}_1, \mathbf{X}_2, \dots, \mathbf{X}_k$  and real numbers  $a_1, a_2, \dots, a_k$ . Any  $\mathbf{X}$  in  $\mathbb{R}^n$  can be written as

$$\begin{aligned} \mathbf{X} &= \begin{bmatrix} x_1 \\ x_2 \\ \vdots \\ x_n \end{bmatrix} = x_1 \begin{bmatrix} 1 \\ 0 \\ \vdots \\ 0 \end{bmatrix} + x_2 \begin{bmatrix} 0 \\ 1 \\ \vdots \\ 0 \end{bmatrix} + \cdots + x_n \begin{bmatrix} 0 \\ 0 \\ \vdots \\ 1 \end{bmatrix} \\ &= x_1\mathbf{E}_1 + x_2\mathbf{E}_2 + \cdots + x_n\mathbf{E}_n. \end{aligned}$$

Applying (6.1.2) with  $k = n$ ,  $\mathbf{X}_i = \mathbf{E}_i$ , and  $a_i = x_i$  yields

$$\mathbf{L}(\mathbf{X}) = x_1\mathbf{L}(\mathbf{E}_1) + x_2\mathbf{L}(\mathbf{E}_2) + \cdots + x_n\mathbf{L}(\mathbf{E}_n). \quad (6.1.3)$$

Now denote

$$\mathbf{L}(\mathbf{E}_j) = \begin{bmatrix} a_{1j} \\ a_{2j} \\ \vdots \\ a_{mj} \end{bmatrix},$$

so (6.1.3) becomes

$$\mathbf{L}(\mathbf{X}) = x_1 \begin{bmatrix} a_{11} \\ a_{21} \\ \vdots \\ a_{m1} \end{bmatrix} + x_2 \begin{bmatrix} a_{12} \\ a_{22} \\ \vdots \\ a_{m2} \end{bmatrix} + \cdots + x_n \begin{bmatrix} a_{1n} \\ a_{2n} \\ \vdots \\ a_{mn} \end{bmatrix},$$

which is equivalent to (6.1.1). This proves that if  $\mathbf{L}$  is linear, then  $\mathbf{L}$  has the form (6.1.1). We leave the proof of the converse to you (Exercise 6.1.2). ■

We call the rectangular array

$$\mathbf{A} = \begin{bmatrix} a_{11} & a_{12} & \cdots & a_{1n} \\ a_{21} & a_{22} & \cdots & a_{2n} \\ \vdots & \vdots & \ddots & \vdots \\ a_{m1} & a_{m2} & \cdots & a_{mn} \end{bmatrix} \quad (6.1.4)$$

the *matrix* of the linear transformation (6.1.1). The number  $a_{ij}$  in the  $i$ th row and  $j$ th column of  $\mathbf{A}$  is called the  $(i, j)$ th entry of  $\mathbf{A}$ . We say that  $\mathbf{A}$  is an  $m \times n$  matrix, since  $\mathbf{A}$  has  $m$  rows and  $n$  columns. We will sometimes abbreviate (6.1.4) as

$$\mathbf{A} = [a_{ij}].$$

**Example 6.1.2** The transformation  $\mathbf{F}$  of Example 6.1.1 is linear. The matrix of  $\mathbf{F}$  is

$$\begin{bmatrix} 2 & 3 \\ -1 & 4 \\ 1 & -1 \end{bmatrix}. \quad \blacksquare$$

We will now recall the matrix operations that we need to study the differential calculus of transformations.

### Definition 6.1.3

(a) If  $c$  is a real number and  $\mathbf{A} = [a_{ij}]$  is an  $m \times n$  matrix, then  $c\mathbf{A}$  is the  $m \times n$  matrix defined by

$$c\mathbf{A} = [ca_{ij}];$$

that is,  $c\mathbf{A}$  is obtained by multiplying every entry of  $\mathbf{A}$  by  $c$ .

(b) If  $\mathbf{A} = [a_{ij}]$  and  $\mathbf{B} = [b_{ij}]$  are  $m \times n$  matrices, then the *sum*  $\mathbf{A} + \mathbf{B}$  is the  $m \times n$  matrix

$$\mathbf{A} + \mathbf{B} = [a_{ij} + b_{ij}];$$

that is, the sum of two  $m \times n$  matrices is obtained by adding corresponding entries. The sum of two matrices is not defined unless they have the same number of rows and the same number of columns.

(c) If  $\mathbf{A} = [a_{ij}]$  is an  $m \times p$  matrix and  $\mathbf{B} = [b_{ij}]$  is a  $p \times n$  matrix, then the *product*  $\mathbf{C} = \mathbf{AB}$  is the  $m \times n$  matrix with

$$c_{ij} = a_{i1}b_{1j} + a_{i2}b_{2j} + \cdots + a_{ip}b_{pj} = \sum_{k=1}^p a_{ik}b_{kj}, \quad 1 \leq i \leq m, \quad 1 \leq j \leq n.$$

Thus, the  $(i, j)$ th entry of  $\mathbf{AB}$  is obtained by multiplying each entry in the  $i$ th row of  $\mathbf{A}$  by the corresponding entry in the  $j$ th column of  $\mathbf{B}$  and adding the products. This definition requires that  $\mathbf{A}$  have the same number of columns as  $\mathbf{B}$  has rows. Otherwise,  $\mathbf{AB}$  is undefined.

**Example 6.1.3** Let

$$\mathbf{A} = \begin{bmatrix} 2 & 1 & 2 \\ -1 & 0 & 3 \\ 0 & 1 & 0 \end{bmatrix}, \quad \mathbf{B} = \begin{bmatrix} 0 & 1 & 1 \\ -1 & 0 & 2 \\ 3 & 0 & 1 \end{bmatrix},$$

and

$$\mathbf{C} = \begin{bmatrix} 5 & 0 & 1 & 2 \\ 3 & 0 & -3 & 1 \\ 1 & 0 & -1 & 1 \end{bmatrix}.$$

Then

$$2\mathbf{A} = \begin{bmatrix} 2(2) & 2(1) & 2(2) \\ 2(-1) & 2(0) & 2(3) \\ 2(0) & 2(1) & 2(0) \end{bmatrix} = \begin{bmatrix} 4 & 2 & 4 \\ -2 & 0 & 6 \\ 0 & 2 & 0 \end{bmatrix}$$

and

$$\mathbf{A} + \mathbf{B} = \begin{bmatrix} 2+0 & 1+1 & 2+1 \\ -1-1 & 0+0 & 3+2 \\ 0+3 & 1+0 & 0+1 \end{bmatrix} = \begin{bmatrix} 2 & 2 & 3 \\ -2 & 0 & 5 \\ 3 & 1 & 1 \end{bmatrix}.$$

The (2, 3) entry in the product  $\mathbf{AC}$  is obtained by multiplying the entries of the second row of  $\mathbf{A}$  by those of the third column of  $\mathbf{C}$  and adding the products: thus, the (2, 3) entry of  $\mathbf{AC}$  is

$$(-1)(1) + (0)(-3) + (3)(-1) = -4.$$

The full product  $\mathbf{AC}$  is

$$\begin{bmatrix} 2 & 1 & 2 \\ -1 & 0 & 3 \\ 0 & 1 & 0 \end{bmatrix} \begin{bmatrix} 5 & 0 & 1 & 2 \\ 3 & 0 & -3 & 1 \\ 1 & 0 & -1 & 1 \end{bmatrix} = \begin{bmatrix} 15 & 0 & -3 & 7 \\ -2 & 0 & -4 & 1 \\ 3 & 0 & -3 & 1 \end{bmatrix}.$$

Notice that  $\mathbf{A} + \mathbf{C}$ ,  $\mathbf{B} + \mathbf{C}$ ,  $\mathbf{CA}$ , and  $\mathbf{CB}$  are undefined. ■

We leave the proofs of next three theorems to you (Exercises 6.1.7–6.1.9)

**Theorem 6.1.4** *If  $\mathbf{A}$ ,  $\mathbf{B}$ , and  $\mathbf{C}$  are  $m \times n$  matrices, then*

$$(\mathbf{A} + \mathbf{B}) + \mathbf{C} = \mathbf{A} + (\mathbf{B} + \mathbf{C}).$$

**Theorem 6.1.5** *If  $\mathbf{A}$  and  $\mathbf{B}$  are  $m \times n$  matrices and  $r$  and  $s$  are real numbers, then (a)  $r(s\mathbf{A}) = (rs)\mathbf{A}$ ; (b)  $(r + s)\mathbf{A} = r\mathbf{A} + s\mathbf{A}$ ; (c)  $r(\mathbf{A} + \mathbf{B}) = r\mathbf{A} + r\mathbf{B}$ .*

**Theorem 6.1.6** *If  $\mathbf{A}$ ,  $\mathbf{B}$ , and  $\mathbf{C}$  are  $m \times p$ ,  $p \times q$ , and  $q \times n$  matrices, respectively, then  $(\mathbf{AB})\mathbf{C} = \mathbf{A}(\mathbf{BC})$ .*

The next theorem shows why Definition 6.1.3 is appropriate. We leave the proof to you (Exercise 6.1.11).

**Theorem 6.1.7**

(a) *If we regard the vector*

$$\mathbf{X} = \begin{bmatrix} x_1 \\ x_2 \\ \vdots \\ x_n \end{bmatrix}$$

*as an  $n \times 1$  matrix, then the linear transformation (6.1.1) can be written as*

$$\mathbf{L}(\mathbf{X}) = \mathbf{A}\mathbf{X}.$$

- (b) If  $\mathbf{L}_1$  and  $\mathbf{L}_2$  are linear transformations from  $\mathbb{R}^n$  to  $\mathbb{R}^m$  with matrices  $\mathbf{A}_1$  and  $\mathbf{A}_2$  respectively, then  $c_1\mathbf{L}_1 + c_2\mathbf{L}_2$  is the linear transformation from  $\mathbb{R}^n$  to  $\mathbb{R}^m$  with matrix  $c_1\mathbf{A}_1 + c_2\mathbf{A}_2$ .
- (c) If  $\mathbf{L}_1 : \mathbb{R}^n \rightarrow \mathbb{R}^p$  and  $\mathbf{L}_2 : \mathbb{R}^p \rightarrow \mathbb{R}^m$  are linear transformations with matrices  $\mathbf{A}_1$  and  $\mathbf{A}_2$ , respectively, then the composite function  $\mathbf{L}_3 = \mathbf{L}_2 \circ \mathbf{L}_1$ , defined by

$$\mathbf{L}_3(\mathbf{X}) = \mathbf{L}_2(\mathbf{L}_1(\mathbf{X})),$$

is the linear transformation from  $\mathbb{R}^n$  to  $\mathbb{R}^m$  with matrix  $\mathbf{A}_2\mathbf{A}_1$ .

**Example 6.1.4** If

$$\mathbf{L}_1(\mathbf{X}) = \begin{bmatrix} 2x + 3y \\ 3x + 2y \\ -x + y \end{bmatrix} \quad \text{and} \quad \mathbf{L}_2(\mathbf{X}) = \begin{bmatrix} -x - y \\ 4x + y \\ x \end{bmatrix},$$

then

$$\mathbf{A}_1 = \begin{bmatrix} 2 & 3 \\ 3 & 2 \\ -1 & 1 \end{bmatrix} \quad \text{and} \quad \mathbf{A}_2 = \begin{bmatrix} -1 & -1 \\ 4 & 1 \\ 1 & 0 \end{bmatrix}.$$

The linear transformation

$$\mathbf{L} = 2\mathbf{L}_1 + \mathbf{L}_2$$

is defined by

$$\begin{aligned} \mathbf{L}(\mathbf{X}) &= 2\mathbf{L}_1(\mathbf{X}) + \mathbf{L}_2(\mathbf{X}) \\ &= 2 \begin{bmatrix} 2x + 3y \\ 3x + 2y \\ -x + y \end{bmatrix} + \begin{bmatrix} -x - y \\ 4x + y \\ x \end{bmatrix} \\ &= \begin{bmatrix} 3x + 5y \\ 10x + 5y \\ -x + 2y \end{bmatrix}. \end{aligned}$$

The matrix of  $\mathbf{L}$  is

$$\mathbf{A} = \begin{bmatrix} 3 & 5 \\ 10 & 5 \\ -1 & 2 \end{bmatrix} = 2\mathbf{A}_1 + \mathbf{A}_2.$$

**Example 6.1.5** Let

$$\mathbf{L}_1(\mathbf{X}) = \begin{bmatrix} x + 2y \\ 3x + 4y \end{bmatrix} : \mathbb{R}^2 \rightarrow \mathbb{R}^2,$$

and

$$\mathbf{L}_2(\mathbf{U}) = \begin{bmatrix} u + v \\ -u - 2v \\ 3u + v \end{bmatrix} : \mathbb{R}^2 \rightarrow \mathbb{R}^3.$$

Then  $\mathbf{L}_3 = \mathbf{L}_2 \circ \mathbf{L}_1 : \mathbb{R}^2 \rightarrow \mathbb{R}^3$  is given by

$$\mathbf{L}_3(\mathbf{X}) = \mathbf{L}_2(\mathbf{L}_1(\mathbf{X})) = \begin{bmatrix} (x+2y) + (3x+4y) \\ -(x+2y) - 2(3x+4y) \\ 3(x+2y) + (3x+4y) \end{bmatrix} = \begin{bmatrix} 4x + 6y \\ -7x - 10y \\ 6x + 10y \end{bmatrix}.$$

The matrices of  $\mathbf{L}_1$  and  $\mathbf{L}_2$  are

$$\mathbf{A}_1 = \begin{bmatrix} 1 & 2 \\ 3 & 4 \end{bmatrix} \quad \text{and} \quad \mathbf{A}_2 = \begin{bmatrix} 1 & 1 \\ -1 & -2 \\ 3 & 1 \end{bmatrix},$$

respectively. The matrix of  $\mathbf{L}_3$  is

$$\mathbf{C} = \begin{bmatrix} 4 & 6 \\ -7 & -10 \\ 6 & 10 \end{bmatrix} = \mathbf{A}_2 \mathbf{A}_1.$$

**Example 6.1.6** The linear transformations of Example 6.1.5 can be written as

$$\mathbf{L}_1(\mathbf{X}) = \begin{bmatrix} 1 & 2 \\ 3 & 4 \end{bmatrix} \begin{bmatrix} x \\ y \end{bmatrix}, \quad \mathbf{L}_2(\mathbf{U}) = \begin{bmatrix} 1 & 1 \\ -1 & -2 \\ 3 & 1 \end{bmatrix} \begin{bmatrix} u \\ v \end{bmatrix},$$

and

$$\mathbf{L}_3(\mathbf{X}) = \begin{bmatrix} 4 & 6 \\ -7 & -10 \\ 6 & 10 \end{bmatrix} \begin{bmatrix} x \\ y \end{bmatrix}.$$

### A New Notation for the Differential

If a real-valued function  $f : \mathbb{R}^n \rightarrow \mathbb{R}$  is differentiable at  $\mathbf{X}_0$ , then

$$d_{\mathbf{X}_0} f = f_{x_1}(\mathbf{X}_0) dx_1 + f_{x_2}(\mathbf{X}_0) dx_2 + \cdots + f_{x_n}(\mathbf{X}_0) dx_n.$$

This can be written as a matrix product

$$d_{\mathbf{X}_0} f = [f_{x_1}(\mathbf{X}_0) \quad f_{x_2}(\mathbf{X}_0) \quad \cdots \quad f_{x_n}(\mathbf{X}_0)] \begin{bmatrix} dx_1 \\ dx_2 \\ \vdots \\ dx_n \end{bmatrix}. \quad (6.1.5)$$

We define the *differential matrix of  $f$  at  $\mathbf{X}_0$*  by

$$f'(\mathbf{X}_0) = [f_{x_1}(\mathbf{X}_0) \quad f_{x_2}(\mathbf{X}_0) \quad \cdots \quad f_{x_n}(\mathbf{X}_0)] \quad (6.1.6)$$

and the *differential linear transformation* by

$$d\mathbf{X} = \begin{bmatrix} dx_1 \\ dx_2 \\ \vdots \\ dx_n \end{bmatrix}.$$



Then (6.1.5) can be rewritten as

$$d_{\mathbf{X}_0} f = f'(\mathbf{X}_0) d\mathbf{X}. \quad (6.1.7)$$

This is analogous to the corresponding formula for functions of one variable (Example 5.3.7), and shows that the differential matrix  $f'(\mathbf{X}_0)$  is a natural generalization of the derivative. With this new notation we can express the defining property of the differential in a way similar to the form that applies for  $n = 1$ :

$$\lim_{\mathbf{X} \rightarrow \mathbf{X}_0} \frac{f(\mathbf{X}) - f(\mathbf{X}_0) - f'(\mathbf{X}_0)(\mathbf{X} - \mathbf{X}_0)}{|\mathbf{X} - \mathbf{X}_0|} = 0,$$

where  $\mathbf{X}_0 = (x_{10}, x_{20}, \dots, x_{n0})$  and  $f'(\mathbf{X}_0)(\mathbf{X} - \mathbf{X}_0)$  is the matrix product

$$[f_{x_1}(\mathbf{X}_0) \quad f_{x_2}(\mathbf{X}_0) \quad \cdots \quad f_{x_n}(\mathbf{X}_0)] \begin{bmatrix} x_1 - x_{10} \\ x_2 - x_{20} \\ \vdots \\ x_n - x_{n0} \end{bmatrix}.$$

As before, we omit the  $\mathbf{X}_0$  in (6.1.6) and (6.1.7) when it is not necessary to emphasize the specific point; thus, we write

$$f' = [f_{x_1} \quad f_{x_2} \quad \cdots \quad f_{x_n}] \quad \text{and} \quad df = f' d\mathbf{X}.$$

**Example 6.1.7** If

$$f(x, y, z) = 4x^2yz^3,$$

then

$$f'(x, y, z) = [8xyz^3 \quad 4x^2z^3 \quad 12x^2yz^2].$$

In particular, if  $\mathbf{X}_0 = (1, -1, 2)$ , then

$$f'(\mathbf{X}_0) = [-64 \quad 32 \quad -48],$$

so

$$\begin{aligned} d_{\mathbf{X}_0} f &= f'(\mathbf{X}_0) d\mathbf{X} = [-64 \quad 32 \quad -48] \begin{bmatrix} dx \\ dy \\ dz \end{bmatrix} \\ &= -64 dx + 32 dy - 48 dz. \end{aligned}$$

### The Norm of a Matrix

We will need the following definition in the next section.

**Definition 6.1.8** The *norm*,  $\|\mathbf{A}\|$ , of an  $m \times n$  matrix  $\mathbf{A} = [a_{ij}]$  is the smallest number such that

$$|\mathbf{A}\mathbf{X}| \leq \|\mathbf{A}\| |\mathbf{X}|$$

for all  $\mathbf{X}$  in  $\mathbb{R}^n$ . ■

To justify this definition, we must show that  $\|\mathbf{A}\|$  exists. The components of  $\mathbf{Y} = \mathbf{A}\mathbf{X}$  are

$$y_i = a_{i1}x_1 + a_{i2}x_2 + \cdots + a_{in}x_n, \quad 1 \leq i \leq m.$$

By Schwarz's inequality,

$$y_i^2 \leq (a_{i1}^2 + a_{i2}^2 + \cdots + a_{in}^2)|\mathbf{X}|^2.$$

Summing this over  $1 \leq i \leq m$  yields

$$|\mathbf{Y}|^2 \leq \left( \sum_{i=1}^m \sum_{j=1}^n a_{ij}^2 \right) |\mathbf{X}|^2.$$

Therefore, the set

$$B = \{K \mid |\mathbf{A}\mathbf{X}| \leq K|\mathbf{X}| \text{ for all } \mathbf{X} \text{ in } \mathbb{R}^n\}$$

is nonempty. Since  $B$  is bounded below by zero,  $B$  has an infimum  $\alpha$ . If  $\epsilon > 0$ , then  $\alpha + \epsilon$  is in  $B$  because if not, then no number less than  $\alpha + \epsilon$  could be in  $B$ . Then  $\alpha + \epsilon$  would be a lower bound for  $B$ , contradicting the definition of  $\alpha$ . Hence,

$$|\mathbf{A}\mathbf{X}| \leq (\alpha + \epsilon)|\mathbf{X}|, \quad \mathbf{X} \in \mathbb{R}^n.$$

Since  $\epsilon$  is an arbitrary positive number, this implies that

$$|\mathbf{A}\mathbf{X}| \leq \alpha|\mathbf{X}|, \quad \mathbf{X} \in \mathbb{R}^n,$$

so  $\alpha \in B$ . Since no smaller number is in  $B$ , we conclude that  $\|\mathbf{A}\| = \alpha$ .

In our applications we will not have to actually compute the norm of a matrix  $\mathbf{A}$ ; rather, it will be sufficient to know that the norm exists (finite).

## Square Matrices

Linear transformations from  $\mathbb{R}^n$  to  $\mathbb{R}^n$  will be important when we discuss the inverse function theorem in Section 6.3 and change of variables in multiple integrals in Section 7.3. The matrix of such a transformation is *square*; that is, it has the same number of rows and columns.

We assume that you know the definition of the determinant

$$\det(\mathbf{A}) = \begin{vmatrix} a_{11} & a_{12} & \cdots & a_{1n} \\ a_{21} & a_{22} & \cdots & a_{2n} \\ \vdots & \vdots & \ddots & \vdots \\ a_{n1} & a_{n2} & \cdots & a_{nn} \end{vmatrix}$$

of an  $n \times n$  matrix

$$\mathbf{A} = \begin{bmatrix} a_{11} & a_{12} & \cdots & a_{1n} \\ a_{21} & a_{22} & \cdots & a_{2n} \\ \vdots & \vdots & \ddots & \vdots \\ a_{n1} & a_{n2} & \cdots & a_{nn} \end{bmatrix}.$$

The *transpose*,  $\mathbf{A}^t$ , of a matrix  $\mathbf{A}$  (square or not) is the matrix obtained by interchanging the rows and columns of  $\mathbf{A}$ ; thus, if

$$\mathbf{A} = \begin{bmatrix} 1 & 2 & 3 \\ 3 & 1 & 4 \\ 0 & 1 & -2 \end{bmatrix}, \quad \text{then} \quad \mathbf{A}^t = \begin{bmatrix} 1 & 3 & 0 \\ 2 & 1 & 1 \\ 3 & 4 & -2 \end{bmatrix}.$$

A square matrix and its transpose have the same determinant; thus,

$$\det(\mathbf{A}^t) = \det(\mathbf{A}).$$

We take the next theorem from linear algebra as given.

**Theorem 6.1.9** *If  $\mathbf{A}$  and  $\mathbf{B}$  are  $n \times n$  matrices, then*

$$\det(\mathbf{AB}) = \det(\mathbf{A}) \det(\mathbf{B}).$$

The entries  $a_{ii}$ ,  $1 \leq i \leq n$ , of an  $n \times n$  matrix  $\mathbf{A}$  are on the *main diagonal* of  $\mathbf{A}$ . The  $n \times n$  matrix with ones on the main diagonal and zeros elsewhere is called the *identity matrix* and is denoted by  $\mathbf{I}$ ; thus, if  $n = 3$ ,

$$\mathbf{I} = \begin{bmatrix} 1 & 0 & 0 \\ 0 & 1 & 0 \\ 0 & 0 & 1 \end{bmatrix}.$$

We call  $\mathbf{I}$  the identity matrix because  $\mathbf{AI} = \mathbf{A}$  and  $\mathbf{IA} = \mathbf{A}$  if  $\mathbf{A}$  is any  $n \times n$  matrix. We say that an  $n \times n$  matrix  $\mathbf{A}$  is *nonsingular* if there is an  $n \times n$  matrix  $\mathbf{A}^{-1}$ , the *inverse of  $\mathbf{A}$* , such that  $\mathbf{AA}^{-1} = \mathbf{A}^{-1}\mathbf{A} = \mathbf{I}$ . Otherwise, we say that  $\mathbf{A}$  is *singular*.

Our main objective is to show that an  $n \times n$  matrix  $\mathbf{A}$  is nonsingular if and only if  $\det(\mathbf{A}) \neq 0$ . We will also find a formula for the inverse.

**Definition 6.1.10** Let  $\mathbf{A} = [a_{ij}]$  be an  $n \times n$  matrix, with  $n \geq 2$ . The *cofactor* of an entry  $a_{ij}$  is

$$c_{ij} = (-1)^{i+j} \det(\mathbf{A}_{ij}),$$

where  $\mathbf{A}_{ij}$  is the  $(n-1) \times (n-1)$  matrix obtained by deleting the  $i$ th row and  $j$ th column of  $\mathbf{A}$ . The *adjoint* of  $\mathbf{A}$ , denoted by  $\text{adj}(\mathbf{A})$ , is the  $n \times n$  matrix whose  $(i, j)$ th entry is  $c_{ji}$ .

**Example 6.1.8** The cofactors of

$$\mathbf{A} = \begin{bmatrix} 4 & 2 & 1 \\ 3 & -1 & 2 \\ 0 & 1 & 2 \end{bmatrix}$$

are

$$\begin{aligned} c_{11} &= \begin{vmatrix} -1 & 2 \\ 1 & 2 \end{vmatrix} = -4, & c_{12} &= -\begin{vmatrix} 3 & 2 \\ 0 & 2 \end{vmatrix} = -6, & c_{13} &= \begin{vmatrix} 3 & -1 \\ 0 & 1 \end{vmatrix} = 3, \\ c_{21} &= -\begin{vmatrix} 2 & 1 \\ 1 & 2 \end{vmatrix} = -3, & c_{22} &= \begin{vmatrix} 4 & 1 \\ 0 & 2 \end{vmatrix} = 8, & c_{23} &= -\begin{vmatrix} 4 & 2 \\ 0 & 1 \end{vmatrix} = -4, \\ c_{31} &= \begin{vmatrix} 2 & 1 \\ -1 & 2 \end{vmatrix} = 5, & c_{32} &= -\begin{vmatrix} 4 & 1 \\ 3 & 2 \end{vmatrix} = -5, & c_{33} &= \begin{vmatrix} 4 & 2 \\ 3 & -1 \end{vmatrix} = -10, \end{aligned}$$

so

$$\text{adj}(\mathbf{A}) = \begin{bmatrix} -4 & -3 & 5 \\ -6 & 8 & -5 \\ 3 & -4 & -10 \end{bmatrix}.$$

Notice that  $\text{adj}(\mathbf{A})$  is the transpose of the matrix

$$\begin{bmatrix} -4 & -6 & 3 \\ -3 & 8 & -4 \\ 5 & -5 & -10 \end{bmatrix}$$

obtained by replacing each entry of  $\mathbf{A}$  by its cofactor. ■

For a proof of the following theorem, see any elementary linear algebra text.

**Theorem 6.1.11** *Let  $\mathbf{A}$  be an  $n \times n$  matrix.*

(a) *The sum of the products of the entries of a row of  $\mathbf{A}$  and their cofactors equals  $\det(\mathbf{A})$ , while the sum of the products of the entries of a row of  $\mathbf{A}$  and the cofactors of the entries of a different row equals zero; that is,*

$$\sum_{k=1}^n a_{ik}c_{jk} = \begin{cases} \det(\mathbf{A}), & i = j, \\ 0, & i \neq j. \end{cases} \quad (6.1.8)$$

(b) *The sum of the products of the entries of a column of  $\mathbf{A}$  and their cofactors equals  $\det(\mathbf{A})$ , while the sum of the products of the entries of a column of  $\mathbf{A}$  and the cofactors of the entries of a different column equals zero; that is,*

$$\sum_{k=1}^n c_{ki}a_{kj} = \begin{cases} \det(\mathbf{A}), & i = j, \\ 0, & i \neq j. \end{cases} \quad (6.1.9)$$

If we compute  $\det(\mathbf{A})$  from the formula

$$\det(\mathbf{A}) = \sum_{k=1}^n a_{ik}c_{ik},$$

we say that we are *expanding the determinant in cofactors of its  $i$ th row*. Since we can choose  $i$  arbitrarily from  $\{1, \dots, n\}$ , there are  $n$  ways to do this. If we compute  $\det(\mathbf{A})$  from the formula

$$\det(\mathbf{A}) = \sum_{k=1}^n a_{kj} c_{kj},$$

we say that we are *expanding the determinant in cofactors of its  $j$ th column*. There are also  $n$  ways to do this.

In particular, we note that  $\det(\mathbf{I}) = 1$  for all  $n \geq 1$ .

**Theorem 6.1.12** *Let  $\mathbf{A}$  be an  $n \times n$  matrix. If  $\det(\mathbf{A}) = 0$ , then  $\mathbf{A}$  is singular. If  $\det(\mathbf{A}) \neq 0$ , then  $\mathbf{A}$  is nonsingular, and  $\mathbf{A}$  has the unique inverse*

$$\mathbf{A}^{-1} = \frac{1}{\det(\mathbf{A})} \text{adj}(\mathbf{A}). \quad (6.1.10)$$

**Proof** If  $\det(\mathbf{A}) = 0$ , then  $\det(\mathbf{A}\mathbf{B}) = 0$  for any  $n \times n$  matrix, by Theorem 6.1.9. Therefore, since  $\det(\mathbf{I}) = 1$ , there is no matrix  $n \times n$  matrix  $\mathbf{B}$  such that  $\mathbf{A}\mathbf{B} = \mathbf{I}$ ; that is,  $\mathbf{A}$  is singular if  $\det(\mathbf{A}) = 0$ . Now suppose that  $\det(\mathbf{A}) \neq 0$ . Since (6.1.8) implies that

$$\mathbf{A} \text{adj}(\mathbf{A}) = \det(\mathbf{A})\mathbf{I}$$

and (6.1.9) implies that

$$\text{adj}(\mathbf{A})\mathbf{A} = \det(\mathbf{A})\mathbf{I},$$

dividing both sides of these two equations by  $\det(\mathbf{A})$  shows that if  $\mathbf{A}^{-1}$  is as defined in (6.1.10), then  $\mathbf{A}\mathbf{A}^{-1} = \mathbf{A}^{-1}\mathbf{A} = \mathbf{I}$ . Therefore,  $\mathbf{A}^{-1}$  is an inverse of  $\mathbf{A}$ . To see that it is the only inverse, suppose that  $\mathbf{B}$  is an  $n \times n$  matrix such that  $\mathbf{A}\mathbf{B} = \mathbf{I}$ . Then  $\mathbf{A}^{-1}(\mathbf{A}\mathbf{B}) = \mathbf{A}^{-1}\mathbf{I}$ , so  $(\mathbf{A}^{-1}\mathbf{A})\mathbf{B} = \mathbf{A}^{-1}$ . Since  $\mathbf{A}\mathbf{A}^{-1} = \mathbf{I}$  and  $\mathbf{I}\mathbf{B} = \mathbf{B}$ , it follows that  $\mathbf{B} = \mathbf{A}^{-1}$ . ■

**Example 6.1.9** In Example 6.1.8 we found that the adjoint of

$$\mathbf{A} = \begin{bmatrix} 4 & 2 & 1 \\ 3 & -1 & 2 \\ 0 & 1 & 2 \end{bmatrix}$$

is

$$\text{adj}(\mathbf{A}) = \begin{bmatrix} -4 & -3 & 5 \\ -6 & 8 & -5 \\ 3 & -4 & -10 \end{bmatrix}.$$

We can compute  $\det(\mathbf{A})$  by finding any diagonal entry of  $\mathbf{A} \text{adj}(\mathbf{A})$ . (Why?) This yields  $\det(\mathbf{A}) = -25$ . (Verify.) Therefore,

$$\mathbf{A}^{-1} = -\frac{1}{25} \begin{bmatrix} -4 & -3 & 5 \\ -6 & 8 & -5 \\ 3 & -4 & -10 \end{bmatrix}. \quad \blacksquare$$

Now consider the equation

$$\mathbf{AX} = \mathbf{Y} \quad (6.1.11)$$

with

$$\mathbf{A} = \begin{bmatrix} a_{11} & a_{12} & \cdots & a_{1n} \\ a_{21} & a_{22} & \cdots & a_{2n} \\ \vdots & \vdots & \ddots & \vdots \\ a_{n1} & a_{n2} & \cdots & a_{nn} \end{bmatrix}, \quad \mathbf{X} = \begin{bmatrix} x_1 \\ x_2 \\ \vdots \\ x_n \end{bmatrix}, \quad \text{and} \quad \mathbf{Y} = \begin{bmatrix} y_1 \\ y_2 \\ \vdots \\ y_n \end{bmatrix}.$$

Here  $\mathbf{A}$  and  $\mathbf{Y}$  are given, and the problem is to find  $\mathbf{X}$ .

**Theorem 6.1.13** *The system (6.1.11) has a solution  $\mathbf{X}$  for any given  $\mathbf{Y}$  if and only if  $\mathbf{A}$  is nonsingular. In this case, the solution is unique and is given by  $\mathbf{X} = \mathbf{A}^{-1}\mathbf{Y}$ .*

**Proof** Suppose that  $\mathbf{A}$  is nonsingular, and let  $\mathbf{X} = \mathbf{A}^{-1}\mathbf{Y}$ . Then

$$\mathbf{AX} = \mathbf{A}(\mathbf{A}^{-1}\mathbf{Y}) = (\mathbf{AA}^{-1})\mathbf{Y} = \mathbf{IY} = \mathbf{Y};$$

that is,  $\mathbf{X}$  is a solution of (6.1.11). To see that  $\mathbf{X}$  is the only solution of (6.1.11), suppose that  $\mathbf{AX}_1 = \mathbf{Y}$ . Then  $\mathbf{AX}_1 = \mathbf{AX}$ , so

$$\mathbf{A}^{-1}(\mathbf{AX}) = \mathbf{A}^{-1}(\mathbf{AX}_1)$$

and

$$(\mathbf{A}^{-1}\mathbf{A})\mathbf{X} = (\mathbf{A}^{-1}\mathbf{A})\mathbf{X}_1,$$

which is equivalent to  $\mathbf{IX} = \mathbf{IX}_1$ , or  $\mathbf{X} = \mathbf{X}_1$ .

Conversely, suppose that (6.1.11) has a solution for every  $\mathbf{Y}$ , and let  $\mathbf{X}_i$  satisfy  $\mathbf{AX}_i = \mathbf{E}_i$ ,  $1 \leq i \leq n$ . Let

$$\mathbf{B} = [\mathbf{X}_1 \ \mathbf{X}_2 \ \cdots \ \mathbf{X}_n];$$

that is,  $\mathbf{X}_1, \mathbf{X}_2, \dots, \mathbf{X}_n$  are the columns of  $\mathbf{B}$ . Then

$$\mathbf{AB} = [\mathbf{AX}_1 \ \mathbf{AX}_2 \ \cdots \ \mathbf{AX}_n] = [\mathbf{E}_1 \ \mathbf{E}_2 \ \cdots \ \mathbf{E}_n] = \mathbf{I}.$$

To show that  $\mathbf{B} = \mathbf{A}^{-1}$ , we must still show that  $\mathbf{BA} = \mathbf{I}$ . We first note that, since  $\mathbf{AB} = \mathbf{I}$  and  $\det(\mathbf{BA}) = \det(\mathbf{AB}) = 1$  (Theorem 6.1.9),  $\mathbf{BA}$  is nonsingular (Theorem 6.1.12). Now note that

$$(\mathbf{BA})(\mathbf{BA}) = \mathbf{B}(\mathbf{AB})\mathbf{A} = \mathbf{BIA};$$

that is,

$$(\mathbf{BA})(\mathbf{BA}) = (\mathbf{BA}).$$

Multiplying both sides of this equation on the left by  $(\mathbf{BA})^{-1}$  yields  $\mathbf{BA} = \mathbf{I}$ . ■

The following theorem gives a useful formula for the components of the solution of (6.1.11).

**Theorem 6.1.14 (Cramer's Rule)** If  $\mathbf{A} = [a_{ij}]$  is nonsingular, then the solution of the system

$$\begin{aligned} a_{11}x_1 + a_{12}x_2 + \cdots + a_{1n}x_n &= y_1 \\ a_{21}x_1 + a_{22}x_2 + \cdots + a_{2n}x_n &= y_2 \\ &\vdots \\ a_{n1}x_1 + a_{n2}x_2 + \cdots + a_{nn}x_n &= y_n \end{aligned}$$

(or, in matrix form,  $\mathbf{AX} = \mathbf{Y}$ ) is given by

$$x_i = \frac{D_i}{\det(\mathbf{A})}, \quad 1 \leq i \leq n,$$

where  $D_i$  is the determinant of the matrix obtained by replacing the  $i$ th column of  $\mathbf{A}$  with  $\mathbf{Y}$ ; thus,

$$D_1 = \begin{vmatrix} y_1 & a_{12} & \cdots & a_{1n} \\ y_2 & a_{22} & \cdots & a_{2n} \\ \vdots & \vdots & \ddots & \vdots \\ y_n & a_{n2} & \cdots & a_{nn} \end{vmatrix}, \quad D_2 = \begin{vmatrix} a_{11} & y_1 & a_{13} & \cdots & a_{1n} \\ a_{21} & y_2 & a_{23} & \cdots & a_{2n} \\ \vdots & \vdots & \vdots & \ddots & \vdots \\ a_{n1} & y_n & a_{n3} & \cdots & a_{nn} \end{vmatrix}, \quad \dots,$$

$$D_n = \begin{vmatrix} a_{11} & \cdots & a_{1,n-1} & y_1 \\ a_{21} & \cdots & a_{2,n-1} & y_2 \\ \vdots & \vdots & \ddots & \vdots \\ a_{n1} & \cdots & a_{n,n-1} & y_n \end{vmatrix}.$$

**Proof** From Theorems 6.1.12 and 6.1.13, the solution of  $\mathbf{AX} = \mathbf{Y}$  is

$$\begin{aligned} \begin{bmatrix} x_1 \\ x_2 \\ \vdots \\ x_n \end{bmatrix} &= \mathbf{A}^{-1}\mathbf{Y} = \frac{1}{\det(\mathbf{A})} \begin{bmatrix} c_{11} & c_{21} & \cdots & c_{n1} \\ c_{12} & c_{22} & \cdots & c_{n2} \\ \cdots & \cdots & \ddots & \cdots \\ c_{1n} & c_{2n} & \cdots & c_{nn} \end{bmatrix} \begin{bmatrix} y_1 \\ y_2 \\ \vdots \\ y_n \end{bmatrix} \\ &= \begin{bmatrix} c_{11}y_1 + c_{21}y_2 + \cdots + c_{n1}y_n \\ c_{12}y_1 + c_{22}y_2 + \cdots + c_{n2}y_n \\ \vdots \\ c_{1n}y_1 + c_{2n}y_2 + \cdots + c_{nn}y_n \end{bmatrix}. \end{aligned}$$

But

$$c_{11}y_1 + c_{21}y_2 + \cdots + c_{n1}y_n = \begin{vmatrix} y_1 & a_{12} & \cdots & a_{1n} \\ y_2 & a_{22} & \cdots & a_{2n} \\ \vdots & \vdots & \ddots & \vdots \\ y_n & a_{n2} & \cdots & a_{nn} \end{vmatrix},$$

as can be seen by expanding the determinant on the right in cofactors of its first column. Similarly,

$$c_{12}y_1 + c_{22}y_2 + \cdots + c_{n2}y_n = \begin{vmatrix} a_{11} & y_1 & a_{13} & \cdots & a_{1n} \\ a_{21} & y_2 & a_{23} & \cdots & a_{2n} \\ \vdots & \vdots & \vdots & \ddots & \vdots \\ a_{n1} & y_n & a_{n3} & \cdots & a_{nn} \end{vmatrix},$$

as can be seen by expanding the determinant on the right in cofactors of its second column. Continuing in this way completes the proof. ■

**Example 6.1.10** The matrix of the system

$$\begin{aligned} 4x + 2y + z &= 1 \\ 3x - y + 2z &= 2 \\ y + 2z &= 0 \end{aligned}$$

is

$$\mathbf{A} = \begin{bmatrix} 4 & 2 & 1 \\ 3 & -1 & 2 \\ 0 & 1 & 2 \end{bmatrix}.$$

Expanding  $\det(\mathbf{A})$  in cofactors of its first row yields

$$\begin{aligned} \det(\mathbf{A}) &= 4 \begin{vmatrix} -1 & 2 \\ 1 & 2 \end{vmatrix} - 2 \begin{vmatrix} 3 & 2 \\ 0 & 2 \end{vmatrix} + 1 \begin{vmatrix} 3 & -1 \\ 0 & 1 \end{vmatrix} \\ &= 4(-4) - 2(6) + 1(3) = -25. \end{aligned}$$

Using Cramer's rule to solve the system yields

$$\begin{aligned} x &= -\frac{1}{25} \begin{vmatrix} 1 & 2 & 1 \\ 2 & -1 & 2 \\ 0 & 1 & 2 \end{vmatrix} = \frac{2}{5}, & y &= -\frac{1}{25} \begin{vmatrix} 4 & 1 & 1 \\ 3 & 2 & 2 \\ 0 & 0 & 2 \end{vmatrix} = -\frac{2}{5}, \\ z &= -\frac{1}{25} \begin{vmatrix} 4 & 2 & 1 \\ 3 & -1 & 2 \\ 0 & 1 & 0 \end{vmatrix} = \frac{1}{5}. \end{aligned} \quad \blacksquare$$

A system of  $n$  equations in  $n$  unknowns

$$\begin{aligned} a_{11}x_1 + a_{12}x_2 + \cdots + a_{1n}x_n &= 0 \\ a_{21}x_1 + a_{22}x_2 + \cdots + a_{2n}x_n &= 0 \\ &\vdots \\ a_{n1}x_1 + a_{n2}x_2 + \cdots + a_{nn}x_n &= 0 \end{aligned} \quad (6.1.12)$$

(or, in matrix form,  $\mathbf{AX} = \mathbf{0}$ ) is *homogeneous*. It is obvious that  $\mathbf{X}_0 = \mathbf{0}$  satisfies this system. We call this the *trivial solution* of (6.1.12). Any other solutions of (6.1.12), if they exist, are *nontrivial*.



We will need the following theorems. The proofs may be found in any linear algebra text.

**Theorem 6.1.15** *The homogeneous system (6.1.12) of  $n$  equations in  $n$  unknowns has a nontrivial solution if and only if  $\det(\mathbf{A}) = 0$ .*

**Theorem 6.1.16** *If  $A_1, A_2, \dots, A_k$  are nonsingular  $n \times n$  matrices, then so is  $A_1 A_2 \cdots A_k$ , and*

$$(A_1 A_2 \cdots A_k)^{-1} = A_k^{-1} A_{k-1}^{-1} \cdots A_1^{-1}.$$

### 6.1 Exercises

1. Prove: If  $\mathbf{L} : \mathbb{R}^n \rightarrow \mathbb{R}^m$  is a linear transformation, then

$$\mathbf{L}(a_1 \mathbf{X}_1 + a_2 \mathbf{X}_2 + \cdots + a_k \mathbf{X}_k) = a_1 \mathbf{L}(\mathbf{X}_1) + a_2 \mathbf{L}(\mathbf{X}_2) + \cdots + a_k \mathbf{L}(\mathbf{X}_k)$$

if  $\mathbf{X}_1, \mathbf{X}_2, \dots, \mathbf{X}_k$  are in  $\mathbb{R}^n$  and  $a_1, a_2, \dots, a_k$  are real numbers.

2. Prove that the transformation  $\mathbf{L}$  defined by Eqn. (6.1.1) is linear.  
3. Find the matrix of  $\mathbf{L}$ .

$$\text{(a) } \mathbf{L}(\mathbf{X}) = \begin{bmatrix} 3x + 4y + 6z \\ 2x - 47 + 2z \\ 7x + 2y + 3z \end{bmatrix} \quad \text{(b) } \mathbf{L}(\mathbf{X}) = \begin{bmatrix} 2x_1 + 4x_2 \\ 3x_1 - 2x_2 \\ 7x_1 - 4x_2 \\ 6x_1 + x_2 \end{bmatrix}$$

4. Find  $c\mathbf{A}$ .

$$\text{(a) } c = 4, \mathbf{A} = \begin{bmatrix} 2 & 2 & 4 & 6 \\ 0 & 0 & 1 & 3 \\ 3 & 4 & 7 & 11 \end{bmatrix} \quad \text{(b) } c = -2, \mathbf{A} = \begin{bmatrix} 1 & 3 & 0 \\ 0 & 1 & 2 \\ 1 & -1 & 3 \end{bmatrix}$$

5. Find  $\mathbf{A} + \mathbf{B}$ .

$$\text{(a) } \mathbf{A} = \begin{bmatrix} -1 & 2 & 3 \\ 1 & 1 & 4 \\ 0 & -1 & 4 \end{bmatrix}, \quad \mathbf{B} = \begin{bmatrix} -1 & 0 & 3 \\ 5 & 6 & -7 \\ 0 & -1 & 2 \end{bmatrix}$$

$$\text{(b) } \mathbf{A} = \begin{bmatrix} 0 & 5 \\ 3 & 2 \\ 1 & 7 \end{bmatrix}, \quad \mathbf{B} = \begin{bmatrix} -1 & 2 \\ 0 & 3 \\ 4 & 7 \end{bmatrix}$$

6. Find  $\mathbf{AB}$ .

$$\text{(a) } \mathbf{A} = \begin{bmatrix} -1 & 2 & 3 \\ 0 & 1 & 4 \\ 0 & -1 & 4 \end{bmatrix}, \quad \mathbf{B} = \begin{bmatrix} -1 & 2 \\ 0 & 3 \\ 4 & 7 \end{bmatrix}$$

$$\text{(b) } \mathbf{A} = \begin{bmatrix} 5 & 3 & 2 & 1 \\ 6 & 7 & 4 & 1 \end{bmatrix}, \quad \mathbf{B} = \begin{bmatrix} 1 \\ 3 \\ 4 \\ 7 \end{bmatrix}$$

7. Prove Theorem 6.1.4.  
 8. Prove Theorem 6.1.5.  
 9. Prove Theorem 6.1.6.  
 10. Suppose that  $\mathbf{A} + \mathbf{B}$  and  $\mathbf{AB}$  are both defined. What can be said about  $\mathbf{A}$  and  $\mathbf{B}$ ?  
 11. Prove Theorem 6.1.7.  
 12. Find the matrix of  $a\mathbf{L}_1 + b\mathbf{L}_2$ .

$$(a) \quad \mathbf{L}_1(x, y, z) = \begin{bmatrix} 3x + 2y + z \\ x + 4y + 2z \\ 3x - 4y + z \end{bmatrix},$$

$$\mathbf{L}_2(x, y, z) = \begin{bmatrix} -x + y - z \\ -2x + y + 3z \\ y + z \end{bmatrix}, \quad a = 2, \quad b = -1$$

$$(b) \quad \mathbf{L}_1(x, y) = \begin{bmatrix} 2x + 3y \\ x - y \\ 4x + y \end{bmatrix}, \quad \mathbf{L}_2(x, y) = \begin{bmatrix} 3x - y \\ x + y \\ -x - y \end{bmatrix}, \quad a = 4, \quad b = 2$$

13. Find the matrices of  $\mathbf{L}_1 \circ \mathbf{L}_2$  and  $\mathbf{L}_2 \circ \mathbf{L}_1$ , where  $\mathbf{L}_1$  and  $\mathbf{L}_2$  are as in Exercise 6.1.12(a).  
 14. Write the transformations of Exercise 6.1.12 in the form  $\mathbf{L}(\mathbf{X}) = \mathbf{AX}$ .  
 15. Find  $f'$  and  $f'(\mathbf{X}_0)$ .  
 (a)  $f(x, y, z) = 3x^2yz$ ,  $\mathbf{X}_0 = (1, -1, 1)$   
 (b)  $f(x, y) = \sin(x + y)$ ,  $\mathbf{X}_0 = (\pi/4, \pi/4)$   
 (c)  $f(x, y, z) = xye^{-xz}$ ,  $\mathbf{X}_0 = (1, 2, 0)$   
 (d)  $f(x, y, z) = \tan(x + 2y + z)$ ,  $\mathbf{X}_0 = (\pi/4, -\pi/8, \pi/4)$   
 (e)  $f(\mathbf{X}) = |\mathbf{X}|: \mathbb{R}^n \rightarrow \mathbb{R}$ ,  $\mathbf{X}_0 = (1/\sqrt{n}, 1/\sqrt{n}, \dots, 1/\sqrt{n})$   
 16. Let  $\mathbf{A} = [a_{ij}]$  be an  $m \times n$  matrix and

$$\lambda = \max \{ |a_{ij}| \mid 1 \leq i \leq m, 1 \leq j \leq n \}.$$

Show that  $\|\mathbf{A}\| \leq \lambda\sqrt{mn}$ .

17. Prove: If  $\mathbf{A}$  has at least one nonzero entry, then  $\|\mathbf{A}\| \neq 0$ .  
 18. Prove:  $\|\mathbf{A} + \mathbf{B}\| \leq \|\mathbf{A}\| + \|\mathbf{B}\|$ .  
 19. Prove:  $\|\mathbf{AB}\| \leq \|\mathbf{A}\| \|\mathbf{B}\|$ .  
 20. Solve by Cramer's rule.

$$(a) \quad \begin{aligned} x + y + 2z &= 1 \\ 2x - y + z &= -1 \\ x - 2y - 3z &= 2 \end{aligned}$$

$$(b) \quad \begin{aligned} x + y - z &= 5 \\ 3x - 2y + 2z &= 0 \\ 4x + 2y - 3z &= 14 \end{aligned}$$

$$\begin{array}{l} x + 2y + 3z = -5 \\ \text{(c) } x \quad \quad - z = -1 \\ x + y + 2z = -4 \end{array} \qquad \begin{array}{l} x - y + z - 2w = 1 \\ \text{(d) } 2x + y - 3z + 3w = 4 \\ 3x + 2y \quad \quad + w = 13 \\ 2x + y - z \quad \quad = 4 \end{array}$$

21. Find  $\mathbf{A}^{-1}$  by the method of Theorem 6.1.12.

$$\text{(a) } \begin{bmatrix} 1 & -2 \\ 3 & 4 \end{bmatrix}$$

$$\text{(b) } \begin{bmatrix} 1 & 2 & 3 \\ 1 & 0 & -1 \\ 1 & 1 & 2 \end{bmatrix}$$

$$\text{(c) } \begin{bmatrix} 4 & 2 & 1 \\ 3 & -1 & 2 \\ 0 & 1 & 2 \end{bmatrix}$$

$$\text{(d) } \begin{bmatrix} 1 & 0 & 1 \\ 0 & 1 & 1 \\ 1 & 1 & 0 \end{bmatrix}$$

$$\text{(e) } \begin{bmatrix} 1 & 2 & 0 & 0 \\ -2 & 3 & 0 & 0 \\ 0 & 0 & 2 & 3 \\ 0 & 0 & -1 & 2 \end{bmatrix}$$

$$\text{(f) } \begin{bmatrix} 1 & 1 & 2 & -1 \\ 2 & 2 & -1 & 3 \\ -1 & 4 & 1 & 2 \\ 3 & 1 & 0 & 1 \end{bmatrix}$$

22. For  $1 \leq i, j \leq m$ , let  $a_{ij} = a_{ij}(\mathbf{X})$  be a real-valued function continuous on a compact set  $K$  in  $\mathbb{R}^n$ . Suppose that the  $m \times m$  matrix

$$\mathbf{A}(\mathbf{X}) = [a_{ij}(\mathbf{X})]$$

is nonsingular for each  $\mathbf{X}$  in  $K$ , and define the  $m \times m$  matrix

$$\mathbf{B}(\mathbf{X}, \mathbf{Y}) = [b_{ij}(\mathbf{X}, \mathbf{Y})]$$

by

$$\mathbf{B}(\mathbf{X}, \mathbf{Y}) = \mathbf{A}^{-1}(\mathbf{X})\mathbf{A}(\mathbf{Y}) - \mathbf{I}.$$

Show that for each  $\epsilon > 0$  there is a  $\delta > 0$  such that

$$|b_{ij}(\mathbf{X}, \mathbf{Y})| < \epsilon, \quad 1 \leq i, j \leq m,$$

if  $\mathbf{X}, \mathbf{Y} \in K$  and  $|\mathbf{X} - \mathbf{Y}| < \delta$ . HINT: Show that  $b_{ij}$  is continuous on the set

$$\{(\mathbf{X}, \mathbf{Y}) \mid \mathbf{X} \in K, \mathbf{Y} \in K\}.$$

Then assume that the conclusion is false and use Exercise 5.1.32 to obtain a contradiction.

## 6.2 CONTINUITY AND DIFFERENTIABILITY OF TRANSFORMATIONS

Throughout the rest of this chapter, transformations  $\mathbf{F}$  and points  $\mathbf{X}$  should be considered as written in vertical form when they occur in connection with matrix operations. However, we will write  $\mathbf{X} = (x_1, x_2, \dots, x_n)$  when  $\mathbf{X}$  is the argument of a function.

## Continuous Transformations

In Section 5.2 we defined a vector-valued function (transformation) to be continuous at  $\mathbf{X}_0$  if each of its component functions is continuous at  $\mathbf{X}_0$ . We leave it to you to show that this implies the following theorem (Exercise 1).

**Theorem 6.2.1** *Suppose that  $\mathbf{X}_0$  is in, and a limit point of, the domain of  $\mathbf{F} : \mathbb{R}^n \rightarrow \mathbb{R}^m$ . Then  $\mathbf{F}$  is continuous at  $\mathbf{X}_0$  if and only if for each  $\epsilon > 0$  there is a  $\delta > 0$  such that*

$$|\mathbf{F}(\mathbf{X}) - \mathbf{F}(\mathbf{X}_0)| < \epsilon \quad \text{if} \quad |\mathbf{X} - \mathbf{X}_0| < \delta \quad \text{and} \quad \mathbf{X} \in D_{\mathbf{F}}. \quad (6.2.1)$$

This theorem is the same as Theorem 5.2.7 except that the “absolute value” in (6.2.1) now stands for distance in  $\mathbb{R}^m$  rather than  $\mathbb{R}$ .

If  $\mathbf{C}$  is a constant vector, then “ $\lim_{\mathbf{X} \rightarrow \mathbf{X}_0} \mathbf{F}(\mathbf{X}) = \mathbf{C}$ ” means that

$$\lim_{\mathbf{X} \rightarrow \mathbf{X}_0} |\mathbf{F}(\mathbf{X}) - \mathbf{C}| = 0.$$

Theorem 6.2.1 implies that  $\mathbf{F}$  is continuous at  $\mathbf{X}_0$  if and only if

$$\lim_{\mathbf{X} \rightarrow \mathbf{X}_0} \mathbf{F}(\mathbf{X}) = \mathbf{F}(\mathbf{X}_0).$$

**Example 6.2.1** The linear transformation

$$\mathbf{L}(\mathbf{X}) = \begin{bmatrix} x + y + z \\ 2x - 3y + z \\ 2x + y - z \end{bmatrix}$$

is continuous at every  $\mathbf{X}_0$  in  $\mathbb{R}^3$ , since

$$\mathbf{L}(\mathbf{X}) - \mathbf{L}(\mathbf{X}_0) = \mathbf{L}(\mathbf{X} - \mathbf{X}_0) = \begin{bmatrix} (x - x_0) + (y - y_0) + (z - z_0) \\ 2(x - x_0) - 3(y - y_0) + (z - z_0) \\ 2(x - x_0) + (y - y_0) - (z - z_0) \end{bmatrix},$$

and applying Schwarz’s inequality to each component yields

$$|\mathbf{L}(\mathbf{X}) - \mathbf{L}(\mathbf{X}_0)|^2 \leq (3 + 14 + 6)|\mathbf{X} - \mathbf{X}_0|^2 = 23|\mathbf{X} - \mathbf{X}_0|^2.$$

Therefore,

$$|\mathbf{L}(\mathbf{X}) - \mathbf{L}(\mathbf{X}_0)| < \epsilon \quad \text{if} \quad |\mathbf{X} - \mathbf{X}_0| < \frac{\epsilon}{\sqrt{23}}.$$

## Differentiable Transformations

In Section 5.4 we defined a vector-valued function (transformation) to be differentiable at  $\mathbf{X}_0$  if each of its components is differentiable at  $\mathbf{X}_0$  (Definition 5.4.1). The next theorem characterizes this property in a useful way.

**Theorem 6.2.2** A transformation  $\mathbf{F} = (f_1, f_2, \dots, f_m)$  defined in a neighborhood of  $\mathbf{X}_0 \in \mathbb{R}^n$  is differentiable at  $\mathbf{X}_0$  if and only if there is a constant  $m \times n$  matrix  $\mathbf{A}$  such that

$$\lim_{\mathbf{X} \rightarrow \mathbf{X}_0} \frac{\mathbf{F}(\mathbf{X}) - \mathbf{F}(\mathbf{X}_0) - \mathbf{A}(\mathbf{X} - \mathbf{X}_0)}{|\mathbf{X} - \mathbf{X}_0|} = \mathbf{0}. \quad (6.2.2)$$

If (6.2.2) holds, then  $\mathbf{A}$  is given uniquely by

$$\mathbf{A} = \left[ \frac{\partial f_i(\mathbf{X}_0)}{\partial x_j} \right] = \begin{bmatrix} \frac{\partial f_1(\mathbf{X}_0)}{\partial x_1} & \frac{\partial f_1(\mathbf{X}_0)}{\partial x_2} & \cdots & \frac{\partial f_1(\mathbf{X}_0)}{\partial x_n} \\ \frac{\partial f_2(\mathbf{X}_0)}{\partial x_1} & \frac{\partial f_2(\mathbf{X}_0)}{\partial x_2} & \cdots & \frac{\partial f_2(\mathbf{X}_0)}{\partial x_n} \\ \vdots & \vdots & \ddots & \vdots \\ \frac{\partial f_m(\mathbf{X}_0)}{\partial x_1} & \frac{\partial f_m(\mathbf{X}_0)}{\partial x_2} & \cdots & \frac{\partial f_m(\mathbf{X}_0)}{\partial x_n} \end{bmatrix}. \quad (6.2.3)$$

**Proof** Let  $\mathbf{X}_0 = (x_{10}, x_{20}, \dots, x_{n0})$ . If  $\mathbf{F}$  is differentiable at  $\mathbf{X}_0$ , then so are  $f_1, f_2, \dots, f_m$  (Definition 5.4.1). Hence,

$$\lim_{\mathbf{X} \rightarrow \mathbf{X}_0} \frac{f_i(\mathbf{X}) - f_i(\mathbf{X}_0) - \sum_{j=1}^n \frac{\partial f_i(\mathbf{X}_0)}{\partial x_j} (x_j - x_{j0})}{|\mathbf{X} - \mathbf{X}_0|} = 0, \quad 1 \leq i \leq m,$$

which implies (6.2.2) with  $\mathbf{A}$  as in (6.2.3).

Now suppose that (6.2.2) holds with  $\mathbf{A} = [a_{ij}]$ . Since each component of the vector in (6.2.2) approaches zero as  $\mathbf{X}$  approaches  $\mathbf{X}_0$ , it follows that

$$\lim_{\mathbf{X} \rightarrow \mathbf{X}_0} \frac{f_i(\mathbf{X}) - f_i(\mathbf{X}_0) - \sum_{j=1}^n a_{ij} (x_j - x_{j0})}{|\mathbf{X} - \mathbf{X}_0|} = 0, \quad 1 \leq i \leq m,$$

so each  $f_i$  is differentiable at  $\mathbf{X}_0$ , and therefore so is  $\mathbf{F}$  (Definition 5.4.1). By Theorem 5.3.6,

$$a_{ij} = \frac{\partial f_i(\mathbf{X}_0)}{\partial x_j}, \quad 1 \leq i \leq m, \quad 1 \leq j \leq n,$$

which implies (6.2.3). ■

A transformation  $\mathbf{T} : \mathbb{R}^n \rightarrow \mathbb{R}^m$  of the form

$$\mathbf{T}(\mathbf{X}) = \mathbf{U} + \mathbf{A}(\mathbf{X} - \mathbf{X}_0),$$

where  $\mathbf{U}$  is a constant vector in  $\mathbb{R}^m$ ,  $\mathbf{X}_0$  is a constant vector in  $\mathbb{R}^n$ , and  $\mathbf{A}$  is a constant  $m \times n$  matrix, is said to be *affine*. Theorem 6.2.2 says that if  $\mathbf{F}$  is differentiable at  $\mathbf{X}_0$ , then  $\mathbf{F}$  can be well approximated by an affine transformation.

**Example 6.2.2** The components of the transformation

$$\mathbf{F}(\mathbf{X}) = \begin{bmatrix} x^2 + 2xy + z \\ x + 2xz + y \\ x^2 + y^2 + z^2 \end{bmatrix}$$

are differentiable at  $\mathbf{X}_0 = (1, 0, 2)$ . Evaluating the partial derivatives of the components there yields

$$\mathbf{A} = \begin{bmatrix} 2 & 2 & 1 \\ 5 & 1 & 2 \\ 2 & 0 & 4 \end{bmatrix}.$$

(Verify). Therefore, Theorem 6.2.2 implies that the affine transformation

$$\begin{aligned} \mathbf{T}(\mathbf{X}) &= \mathbf{F}(\mathbf{X}_0) + \mathbf{A}(\mathbf{X} - \mathbf{X}_0) \\ &= \begin{bmatrix} 3 \\ 5 \\ 5 \end{bmatrix} + \begin{bmatrix} 2 & 2 & 1 \\ 5 & 1 & 2 \\ 2 & 0 & 4 \end{bmatrix} \begin{bmatrix} x - 1 \\ y \\ z - 2 \end{bmatrix} \end{aligned}$$

satisfies

$$\lim_{\mathbf{X} \rightarrow \mathbf{X}_0} \frac{\mathbf{F}(\mathbf{X}) - \mathbf{T}(\mathbf{X})}{|\mathbf{X} - \mathbf{X}_0|} = \mathbf{0}.$$

### Differential of a Transformation

If  $\mathbf{F} = (f_1, f_2, \dots, f_m)$  is differentiable at  $\mathbf{X}_0$ , we define the *differential of  $\mathbf{F}$  at  $\mathbf{X}_0$*  to be the linear transformation

$$d_{\mathbf{X}_0} \mathbf{F} = \begin{bmatrix} d_{\mathbf{X}_0} f_1 \\ d_{\mathbf{X}_0} f_2 \\ \vdots \\ d_{\mathbf{X}_0} f_m \end{bmatrix}. \quad (6.2.4)$$

We call the matrix  $\mathbf{A}$  in (6.2.3) the *differential matrix of  $\mathbf{F}$  at  $\mathbf{X}_0$*  and denote it by  $\mathbf{F}'(\mathbf{X}_0)$ ; thus,

$$\mathbf{F}'(\mathbf{X}_0) = \begin{bmatrix} \frac{\partial f_1(\mathbf{X}_0)}{\partial x_1} & \frac{\partial f_1(\mathbf{X}_0)}{\partial x_2} & \cdots & \frac{\partial f_1(\mathbf{X}_0)}{\partial x_n} \\ \frac{\partial f_2(\mathbf{X}_0)}{\partial x_1} & \frac{\partial f_2(\mathbf{X}_0)}{\partial x_2} & \cdots & \frac{\partial f_2(\mathbf{X}_0)}{\partial x_n} \\ \vdots & \vdots & \ddots & \vdots \\ \frac{\partial f_m(\mathbf{X}_0)}{\partial x_1} & \frac{\partial f_m(\mathbf{X}_0)}{\partial x_2} & \cdots & \frac{\partial f_m(\mathbf{X}_0)}{\partial x_n} \end{bmatrix}. \quad (6.2.5)$$

(It is important to bear in mind that while  $\mathbf{F}$  is a function from  $\mathbb{R}^n$  to  $\mathbb{R}^m$ ,  $\mathbf{F}'$  is not such a function;  $\mathbf{F}'$  is an  $m \times n$  matrix.) From Theorem 6.2.2, the differential can be written in terms of the differential matrix as

$$d_{\mathbf{X}_0}\mathbf{F} = \mathbf{F}'(\mathbf{X}_0) \begin{bmatrix} dx_1 \\ dx_2 \\ \vdots \\ dx_n \end{bmatrix} \quad (6.2.6)$$

or, more succinctly, as

$$d_{\mathbf{X}_0}\mathbf{F} = \mathbf{F}'(\mathbf{X}_0) d\mathbf{X},$$

where

$$d\mathbf{X} = \begin{bmatrix} dx_1 \\ dx_2 \\ \vdots \\ dx_n \end{bmatrix},$$

as defined earlier.

When it is not necessary to emphasize the particular point  $\mathbf{X}_0$ , we write (6.2.4) as

$$d\mathbf{F} = \begin{bmatrix} df_1 \\ df_2 \\ \vdots \\ df_m \end{bmatrix},$$

(6.2.5) as

$$\mathbf{F}' = \begin{bmatrix} \frac{\partial f_1}{\partial x_1} & \frac{\partial f_1}{\partial x_2} & \cdots & \frac{\partial f_1}{\partial x_n} \\ \frac{\partial f_2}{\partial x_1} & \frac{\partial f_2}{\partial x_2} & \cdots & \frac{\partial f_2}{\partial x_n} \\ \vdots & \vdots & \ddots & \vdots \\ \frac{\partial f_m}{\partial x_1} & \frac{\partial f_m}{\partial x_2} & \cdots & \frac{\partial f_m}{\partial x_n} \end{bmatrix},$$

and (6.2.6) as

$$d\mathbf{F} = \mathbf{F}' d\mathbf{X}.$$

With the differential notation we can rewrite (6.2.2) as

$$\lim_{\mathbf{X} \rightarrow \mathbf{X}_0} \frac{\mathbf{F}(\mathbf{X}) - \mathbf{F}(\mathbf{X}_0) - \mathbf{F}'(\mathbf{X}_0)(\mathbf{X} - \mathbf{X}_0)}{|\mathbf{X} - \mathbf{X}_0|} = \mathbf{0}.$$

**Example 6.2.3** The linear transformation

$$\mathbf{F}(\mathbf{X}) = \begin{bmatrix} a_{11}x_1 + a_{12}x_2 + \cdots + a_{1n}x_n \\ a_{21}x_1 + a_{22}x_2 + \cdots + a_{2n}x_n \\ \vdots \\ a_{m1}x_1 + a_{m2}x_2 + \cdots + a_{mn}x_n \end{bmatrix}$$

can be written as  $\mathbf{F}(\mathbf{X}) = \mathbf{A}\mathbf{X}$ , where  $\mathbf{A} = [a_{ij}]$ . Then

$$\mathbf{F}' = \mathbf{A};$$

that is, the differential matrix of a linear transformation is independent of  $\mathbf{X}$  and is the matrix of the transformation. For example, the differential matrix of

$$\mathbf{F}(x_1, x_2, x_3) = \begin{bmatrix} 1 & 2 & 3 \\ 2 & 1 & 0 \end{bmatrix} \begin{bmatrix} x_1 \\ x_2 \\ x_3 \end{bmatrix}$$

is

$$\mathbf{F}' = \begin{bmatrix} 1 & 2 & 3 \\ 2 & 1 & 0 \end{bmatrix}.$$

If  $\mathbf{F}(\mathbf{X}) = \mathbf{X}$  (the identity transformation), then  $\mathbf{F}' = \mathbf{I}$  (the identity matrix).

**Example 6.2.4** The transformation

$$\mathbf{F}(x, y) = \begin{bmatrix} \frac{x}{x^2 + y^2} \\ \frac{y}{x^2 + y^2} \\ 2xy \end{bmatrix}$$

is differentiable at every point of  $\mathbb{R}^2$  except  $(0, 0)$ , and

$$\mathbf{F}'(x, y) = \begin{bmatrix} \frac{y^2 - x^2}{(x^2 + y^2)^2} & -\frac{2xy}{(x^2 + y^2)^2} \\ -\frac{2xy}{(x^2 + y^2)^2} & \frac{x^2 - y^2}{(x^2 + y^2)^2} \\ 2y & 2x \end{bmatrix}.$$

In particular,

$$\mathbf{F}'(1, 1) = \begin{bmatrix} 0 & -\frac{1}{2} \\ -\frac{1}{2} & 0 \\ 2 & 2 \end{bmatrix},$$



so

$$\begin{aligned} \lim_{(x,y) \rightarrow (1,1)} \frac{1}{\sqrt{(x-1)^2 + (y-1)^2}} \left( \mathbf{F}(x,y) - \begin{bmatrix} \frac{1}{2} \\ \frac{1}{2} \\ 2 \end{bmatrix} - \begin{bmatrix} 0 & -\frac{1}{2} \\ -\frac{1}{2} & 0 \\ 2 & 2 \end{bmatrix} \begin{bmatrix} x-1 \\ y-1 \end{bmatrix} \right) \\ = \begin{bmatrix} 0 \\ 0 \\ 0 \end{bmatrix}. \quad \blacksquare \end{aligned}$$

If  $m = n$ , the differential matrix is square and its determinant is called the *Jacobian* of  $\mathbf{F}$ . The standard notation for this determinant is

$$\frac{\partial(f_1, f_2, \dots, f_n)}{\partial(x_1, x_2, \dots, x_n)} = \begin{vmatrix} \frac{\partial f_1}{\partial x_1} & \frac{\partial f_1}{\partial x_2} & \cdots & \frac{\partial f_1}{\partial x_n} \\ \frac{\partial f_2}{\partial x_1} & \frac{\partial f_2}{\partial x_2} & \cdots & \frac{\partial f_2}{\partial x_n} \\ \vdots & \vdots & \ddots & \vdots \\ \frac{\partial f_n}{\partial x_1} & \frac{\partial f_n}{\partial x_2} & \cdots & \frac{\partial f_n}{\partial x_n} \end{vmatrix}.$$

We will often write the Jacobian of  $\mathbf{F}$  more simply as  $J(\mathbf{F})$ , and its value at  $\mathbf{X}_0$  as  $J\mathbf{F}(\mathbf{X}_0)$ .

Since an  $n \times n$  matrix is nonsingular if and only if its determinant is nonzero, it follows that if  $\mathbf{F} : \mathbb{R}^n \rightarrow \mathbb{R}^n$  is differentiable at  $\mathbf{X}_0$ , then  $\mathbf{F}'(\mathbf{X}_0)$  is nonsingular if and only if  $J\mathbf{F}(\mathbf{X}_0) \neq 0$ . We will soon use this important fact.

**Example 6.2.5** If

$$\mathbf{F}(x, y, z) = \begin{bmatrix} x^2 - 2x + z \\ x + 2xy + z^2 \\ x + y + z \end{bmatrix},$$

then

$$\begin{aligned} \frac{\partial(f_1, f_2, f_3)}{\partial(x_1, x_2, x_3)} = J\mathbf{F}(\mathbf{X}) &= \begin{vmatrix} 2x-2 & 0 & 1 \\ 1+2y & 2x & 2z \\ 1 & 1 & 1 \end{vmatrix} \\ &= (2x-2) \begin{vmatrix} 2x & 2z \\ 1 & 1 \end{vmatrix} + \begin{vmatrix} 1+2y & 2x \\ 1 & 1 \end{vmatrix} \\ &= (2x-2)(2x-2z) + (1+2y-2x). \end{aligned}$$

In particular,  $J\mathbf{F}(1, -1, 1) = -3$ , so the differential matrix

$$\mathbf{F}'(1, -1, 1) = \begin{bmatrix} 0 & 0 & 1 \\ -1 & 2 & 2 \\ 1 & 1 & 1 \end{bmatrix}$$

is nonsingular.

### Properties of Differentiable Transformations

We leave the proof of the following theorem to you (Exercise 6.2.16).

**Theorem 6.2.3** *If  $\mathbf{F} : \mathbb{R}^n \rightarrow \mathbb{R}^m$  is differentiable at  $\mathbf{X}_0$ , then  $\mathbf{F}$  is continuous at  $\mathbf{X}_0$ .*

Theorem 5.3.10 and Definition 5.4.1 imply the following theorem.

**Theorem 6.2.4** *Let  $\mathbf{F} = (f_1, f_2, \dots, f_m) : \mathbb{R}^n \rightarrow \mathbb{R}^m$ , and suppose that the partial derivatives*

$$\frac{\partial f_i}{\partial x_j}, \quad 1 \leq i \leq m, \quad 1 \leq j \leq n, \quad (6.2.7)$$

*exist on a neighborhood of  $\mathbf{X}_0$  and are continuous at  $\mathbf{X}_0$ . Then  $\mathbf{F}$  is differentiable at  $\mathbf{X}_0$ .*

We say that  $\mathbf{F}$  is *continuously differentiable* on a set  $S$  if  $S$  is contained in an open set on which the partial derivatives in (6.2.7) are continuous. The next three lemmas give properties of continuously differentiable transformations that we will need later.

**Lemma 6.2.5** *Suppose that  $\mathbf{F} : \mathbb{R}^n \rightarrow \mathbb{R}^m$  is continuously differentiable on a neighborhood  $N$  of  $\mathbf{X}_0$ . Then, for every  $\epsilon > 0$ , there is a  $\delta > 0$  such that*

$$\|\mathbf{F}(\mathbf{X}) - \mathbf{F}(\mathbf{Y})\| < (\|\mathbf{F}'(\mathbf{X}_0)\| + \epsilon)\|\mathbf{X} - \mathbf{Y}\| \quad \text{if } \mathbf{X}, \mathbf{Y} \in B_\delta(\mathbf{X}_0). \quad (6.2.8)$$

**Proof** Consider the auxiliary function

$$\mathbf{G}(\mathbf{X}) = \mathbf{F}(\mathbf{X}) - \mathbf{F}'(\mathbf{X}_0)\mathbf{X}. \quad (6.2.9)$$

The components of  $\mathbf{G}$  are

$$g_i(\mathbf{X}) = f_i(\mathbf{X}) - \sum_{j=1}^n \frac{\partial f_i(\mathbf{X}_0) \partial x_j}{x_j},$$

so

$$\frac{\partial g_i(\mathbf{X})}{\partial x_j} = \frac{\partial f_i(\mathbf{X})}{\partial x_j} - \frac{\partial f_i(\mathbf{X}_0)}{\partial x_j}.$$

Thus,  $\partial g_i / \partial x_j$  is continuous on  $N$  and zero at  $\mathbf{X}_0$ . Therefore, there is a  $\delta > 0$  such that

$$\left| \frac{\partial g_i(\mathbf{X})}{\partial x_j} \right| < \frac{\epsilon}{\sqrt{mn}} \quad \text{for } 1 \leq i \leq m, \quad 1 \leq j \leq n, \quad \text{if } |\mathbf{X} - \mathbf{X}_0| < \delta. \quad (6.2.10)$$

Now suppose that  $\mathbf{X}, \mathbf{Y} \in B_\delta(\mathbf{X}_0)$ . By Theorem 5.4.5,

$$g_i(\mathbf{X}) - g_i(\mathbf{Y}) = \sum_{j=1}^n \frac{\partial g_i(\mathbf{X}_i)}{\partial x_j} (x_j - y_j), \quad (6.2.11)$$

where  $\mathbf{X}_i$  is on the line segment from  $\mathbf{X}$  to  $\mathbf{Y}$ , so  $\mathbf{X}_i \in B_\delta(\mathbf{X}_0)$ . From (6.2.10), (6.2.11), and Schwarz's inequality,

$$(g_i(\mathbf{X}) - g_i(\mathbf{Y}))^2 \leq \left( \sum_{j=1}^n \left[ \frac{\partial g_i(\mathbf{X}_i)}{\partial x_j} \right]^2 \right) |\mathbf{X} - \mathbf{Y}|^2 < \frac{\epsilon^2}{m} |\mathbf{X} - \mathbf{Y}|^2.$$

Summing this from  $i = 1$  to  $i = m$  and taking square roots yields

$$|\mathbf{G}(\mathbf{X}) - \mathbf{G}(\mathbf{Y})| < \epsilon |\mathbf{X} - \mathbf{Y}| \quad \text{if } \mathbf{X}, \mathbf{Y} \in B_\delta(\mathbf{X}_0). \quad (6.2.12)$$

To complete the proof, we note that

$$\mathbf{F}(\mathbf{X}) - \mathbf{F}(\mathbf{Y}) = \mathbf{G}(\mathbf{X}) - \mathbf{G}(\mathbf{Y}) + \mathbf{F}'(\mathbf{X}_0)(\mathbf{X} - \mathbf{Y}), \quad (6.2.13)$$

so (6.2.12) and the triangle inequality imply (6.2.8). ■

**Lemma 6.2.6** Suppose that  $\mathbf{F} : \mathbb{R}^n \rightarrow \mathbb{R}^n$  is continuously differentiable on a neighborhood of  $\mathbf{X}_0$  and  $\mathbf{F}'(\mathbf{X}_0)$  is nonsingular. Let

$$r = \frac{1}{\|(\mathbf{F}'(\mathbf{X}_0))^{-1}\|}. \quad (6.2.14)$$

Then, for every  $\epsilon > 0$ , there is a  $\delta > 0$  such that

$$|\mathbf{F}(\mathbf{X}) - \mathbf{F}(\mathbf{Y})| \geq (r - \epsilon) |\mathbf{X} - \mathbf{Y}| \quad \text{if } \mathbf{X}, \mathbf{Y} \in B_\delta(\mathbf{X}_0). \quad (6.2.15)$$

**Proof** Let  $\mathbf{X}$  and  $\mathbf{Y}$  be arbitrary points in  $D_{\mathbf{F}}$  and let  $\mathbf{G}$  be as in (6.2.9). From (6.2.13),

$$|\mathbf{F}(\mathbf{X}) - \mathbf{F}(\mathbf{Y})| \geq \left| |\mathbf{F}'(\mathbf{X}_0)(\mathbf{X} - \mathbf{Y})| - |\mathbf{G}(\mathbf{X}) - \mathbf{G}(\mathbf{Y})| \right|, \quad (6.2.16)$$

Since

$$\mathbf{X} - \mathbf{Y} = [\mathbf{F}'(\mathbf{X}_0)]^{-1} \mathbf{F}'(\mathbf{X}_0)(\mathbf{X} - \mathbf{Y}),$$

(6.2.14) implies that

$$|\mathbf{X} - \mathbf{Y}| \leq \frac{1}{r} |\mathbf{F}'(\mathbf{X}_0)(\mathbf{X} - \mathbf{Y})|,$$

so

$$|\mathbf{F}'(\mathbf{X}_0)(\mathbf{X} - \mathbf{Y})| \geq r |\mathbf{X} - \mathbf{Y}|. \quad (6.2.17)$$

Now choose  $\delta > 0$  so that (6.2.12) holds. Then (6.2.16) and (6.2.17) imply (6.2.15). ■

See Exercise 6.2.19 for a stronger conclusion in the case where  $\mathbf{F}$  is linear.

**Lemma 6.2.7** *If  $\mathbf{F} : \mathbb{R}^n \rightarrow \mathbb{R}^m$  is continuously differentiable on an open set containing a compact set  $D$ , then there is a constant  $M$  such that*

$$|\mathbf{F}(\mathbf{Y}) - \mathbf{F}(\mathbf{X})| \leq M|\mathbf{Y} - \mathbf{X}| \quad \text{if } \mathbf{X}, \mathbf{Y} \in D. \quad (6.2.18)$$

**Proof** On

$$S = \{(\mathbf{X}, \mathbf{Y}) \mid \mathbf{X}, \mathbf{Y} \in D\} \subset \mathbb{R}^{2n}$$

define

$$g(\mathbf{X}, \mathbf{Y}) = \begin{cases} \frac{|\mathbf{F}(\mathbf{Y}) - \mathbf{F}(\mathbf{X}) - \mathbf{F}'(\mathbf{X})(\mathbf{Y} - \mathbf{X})|}{|\mathbf{Y} - \mathbf{X}|}, & \mathbf{Y} \neq \mathbf{X}, \\ 0, & \mathbf{Y} = \mathbf{X}. \end{cases}$$

Then  $g$  is continuous for all  $(\mathbf{X}, \mathbf{Y})$  in  $S$  such that  $\mathbf{X} \neq \mathbf{Y}$ . We now show that if  $\mathbf{X}_0 \in D$ , then

$$\lim_{(\mathbf{X}, \mathbf{Y}) \rightarrow (\mathbf{X}_0, \mathbf{X}_0)} g(\mathbf{X}, \mathbf{Y}) = 0 = g(\mathbf{X}_0, \mathbf{X}_0); \quad (6.2.19)$$

that is,  $g$  is also continuous at points  $(\mathbf{X}_0, \mathbf{X}_0)$  in  $S$ .

Suppose that  $\epsilon > 0$  and  $\mathbf{X}_0 \in D$ . Since the partial derivatives of  $f_1, f_2, \dots, f_m$  are continuous on an open set containing  $D$ , there is a  $\delta > 0$  such that

$$\left| \frac{\partial f_i(\mathbf{Y})}{\partial x_j} - \frac{\partial f_i(\mathbf{X})}{\partial x_j} \right| < \frac{\epsilon}{\sqrt{mn}} \quad \text{if } \mathbf{X}, \mathbf{Y} \in B_\delta(\mathbf{X}_0), \quad 1 \leq i \leq m, \quad 1 \leq j \leq n. \quad (6.2.20)$$

(Note that  $\partial f_i / \partial x_j$  is uniformly continuous on  $\overline{B_\delta(\mathbf{X}_0)}$  for  $\delta$  sufficiently small, from Theorem 5.2.14.) Applying Theorem 5.4.5 to  $f_1, f_2, \dots, f_m$ , we find that if  $\mathbf{X}, \mathbf{Y} \in B_\delta(\mathbf{X}_0)$ , then

$$f_i(\mathbf{Y}) - f_i(\mathbf{X}) = \sum_{j=1}^n \frac{\partial f_i(\mathbf{X}_i)}{\partial x_j} (y_j - x_j),$$

where  $\mathbf{X}_i$  is on the line segment from  $\mathbf{X}$  to  $\mathbf{Y}$ . From this,

$$\begin{aligned} \left[ f_i(\mathbf{Y}) - f_i(\mathbf{X}) - \sum_{j=1}^n \frac{\partial f_i(\mathbf{X})}{\partial x_j} (y_j - x_j) \right]^2 &= \left[ \sum_{j=1}^n \left[ \frac{\partial f_i(\mathbf{X}_i)}{\partial x_j} - \frac{\partial f_i(\mathbf{X})}{\partial x_j} \right] (y_j - x_j) \right]^2 \\ &\leq |\mathbf{Y} - \mathbf{X}|^2 \sum_{j=1}^n \left[ \frac{\partial f_i(\mathbf{X}_i)}{\partial x_j} - \frac{\partial f_i(\mathbf{X})}{\partial x_j} \right]^2 \\ &\quad \text{(by Schwarz's inequality)} \\ &< \frac{\epsilon^2}{m} |\mathbf{Y} - \mathbf{X}|^2 \quad \text{(by (6.2.20))} . \end{aligned}$$

Summing from  $i = 1$  to  $i = m$  and taking square roots yields

$$|\mathbf{F}(\mathbf{Y}) - \mathbf{F}(\mathbf{X}) - \mathbf{F}'(\mathbf{X})(\mathbf{Y} - \mathbf{X})| < \epsilon |\mathbf{Y} - \mathbf{X}| \quad \text{if } \mathbf{X}, \mathbf{Y} \in B_\delta(\mathbf{X}_0).$$

This implies (6.2.19) and completes the proof that  $g$  is continuous on  $S$ .

Since  $D$  is compact, so is  $S$  (Exercise 5.1.27). Therefore,  $g$  is bounded on  $S$  (Theorem 5.2.12); thus, for some  $M_1$ ,

$$|\mathbf{F}(\mathbf{Y}) - \mathbf{F}(\mathbf{X}) - \mathbf{F}'(\mathbf{X})(\mathbf{Y} - \mathbf{X})| \leq M_1|\mathbf{X} - \mathbf{Y}| \quad \text{if } \mathbf{X}, \mathbf{Y} \in D.$$

But

$$\begin{aligned} |\mathbf{F}(\mathbf{Y}) - \mathbf{F}(\mathbf{X})| &\leq |\mathbf{F}(\mathbf{Y}) - \mathbf{F}(\mathbf{X}) - \mathbf{F}'(\mathbf{X})(\mathbf{Y} - \mathbf{X})| + |\mathbf{F}'(\mathbf{X})(\mathbf{Y} - \mathbf{X})| \\ &\leq (M_1 + \|\mathbf{F}'(\mathbf{X})\|)|\mathbf{Y} - \mathbf{X}|. \end{aligned} \quad (6.2.21)$$

Since

$$\|\mathbf{F}'(\mathbf{X})\| \leq \left( \sum_{i=1}^m \sum_{j=1}^n \left[ \frac{\partial f_i(\mathbf{X})}{\partial x_j} \right]^2 \right)^{1/2}$$

and the partial derivatives  $\{\partial f_i/\partial x_j\}$  are bounded on  $D$ , it follows that  $\|\mathbf{F}'(\mathbf{X})\|$  is bounded on  $D$ ; that is, there is a constant  $M_2$  such that

$$\|\mathbf{F}'(\mathbf{X})\| \leq M_2, \quad \mathbf{X} \in D.$$

Now (6.2.21) implies (6.2.18) with  $M = M_1 + M_2$ . ■

### The Chain Rule for Transformations

By using differential matrices, we can write the chain rule for transformations in a form analogous to the form of the chain rule for real-valued functions of one variable (Theorem 2.3.5).

**Theorem 6.2.8** *Suppose that  $\mathbf{F} : \mathbb{R}^n \rightarrow \mathbb{R}^m$  is differentiable at  $\mathbf{X}_0$ ,  $\mathbf{G} : \mathbb{R}^k \rightarrow \mathbb{R}^n$  is differentiable at  $\mathbf{U}_0$ , and  $\mathbf{X}_0 = \mathbf{G}(\mathbf{U}_0)$ . Then the composite function  $\mathbf{H} = \mathbf{F} \circ \mathbf{G} : \mathbb{R}^k \rightarrow \mathbb{R}^m$ , defined by*

$$\mathbf{H}(\mathbf{U}) = \mathbf{F}(\mathbf{G}(\mathbf{U})),$$

*is differentiable at  $\mathbf{U}_0$ . Moreover,*

$$\mathbf{H}'(\mathbf{U}_0) = \mathbf{F}'(\mathbf{G}(\mathbf{U}_0))\mathbf{G}'(\mathbf{U}_0) \quad (6.2.22)$$

and

$$d_{\mathbf{U}_0}\mathbf{H} = d_{\mathbf{X}_0}\mathbf{F} \circ d_{\mathbf{U}_0}\mathbf{G}, \quad (6.2.23)$$

where  $\circ$  denotes composition.

**Proof** The components of  $\mathbf{H}$  are  $h_1, h_2, \dots, h_m$ , where

$$h_i(\mathbf{U}) = f_i(\mathbf{G}(\mathbf{U})).$$

Applying Theorem 5.4.3 to  $h_i$  yields

$$d_{\mathbf{U}_0}h_i = \sum_{j=1}^n \frac{\partial f_i(\mathbf{X}_0)}{\partial x_j} d_{\mathbf{U}_0}g_j, \quad 1 \leq i \leq m. \quad (6.2.24)$$

Since

$$d_{\mathbf{U}_0}\mathbf{H} = \begin{bmatrix} d_{\mathbf{U}_0}h_1 \\ d_{\mathbf{U}_0}h_2 \\ \vdots \\ d_{\mathbf{U}_0}h_m \end{bmatrix} \quad \text{and} \quad d_{\mathbf{U}_0}\mathbf{G} = \begin{bmatrix} d_{\mathbf{U}_0}g_1 \\ d_{\mathbf{U}_0}g_2 \\ \vdots \\ d_{\mathbf{U}_0}g_n \end{bmatrix},$$

the  $m$  equations in (6.2.24) can be written in matrix form as

$$d_{\mathbf{U}_0}\mathbf{H} = \mathbf{F}'(\mathbf{X}_0)d_{\mathbf{U}_0}\mathbf{G} = \mathbf{F}'(\mathbf{G}(\mathbf{U}_0))d_{\mathbf{U}_0}\mathbf{G}. \quad (6.2.25)$$

But

$$d_{\mathbf{U}_0}\mathbf{G} = \mathbf{G}'(\mathbf{U}_0) d\mathbf{U},$$

where

$$d\mathbf{U} = \begin{bmatrix} du_1 \\ du_2 \\ \vdots \\ du_k \end{bmatrix},$$

so (6.2.25) can be rewritten as

$$d_{\mathbf{U}_0}\mathbf{H} = \mathbf{F}'(\mathbf{G}(\mathbf{U}_0))\mathbf{G}'(\mathbf{U}_0) d\mathbf{U}.$$

On the other hand,

$$d_{\mathbf{U}_0}\mathbf{H} = \mathbf{H}'(\mathbf{U}_0) d\mathbf{U}.$$

Comparing the last two equations yields (6.2.22). Since  $\mathbf{G}'(\mathbf{U}_0)$  is the matrix of  $d_{\mathbf{U}_0}\mathbf{G}$  and  $\mathbf{F}'(\mathbf{G}(\mathbf{U}_0)) = \mathbf{F}'(\mathbf{X}_0)$  is the matrix of  $d_{\mathbf{X}_0}\mathbf{F}$ , Theorem 6.1.7(c) and (6.2.22) imply (6.2.23). ■

**Example 6.2.6** Let  $\mathbf{U}_0 = (1, -1)$ ,

$$\mathbf{G}(\mathbf{U}) = \mathbf{G}(u, v) = \begin{bmatrix} \sqrt{u} \\ \sqrt{u^2 + 3v^2} \\ \sqrt{v + 2} \end{bmatrix}, \quad \mathbf{F}(\mathbf{X}) = \mathbf{F}(x, y, z) = \begin{bmatrix} x^2 + y^2 + 2z^2 \\ x^2 - y^2 \end{bmatrix},$$

and

$$\mathbf{H}(\mathbf{U}) = \mathbf{F}(\mathbf{G}(\mathbf{U})).$$

Since  $\mathbf{G}$  is differentiable at  $\mathbf{U}_0 = (1, -1)$  and  $\mathbf{F}$  is differentiable at

$$\mathbf{X}_0 = \mathbf{G}(\mathbf{U}_0) = (1, 2, 1),$$

Theorem 6.2.8 implies that  $\mathbf{H}$  is differentiable at  $(1, -1)$ . To find  $\mathbf{H}'(1, -1)$  from (6.2.22), we first find that

$$\mathbf{G}'(\mathbf{U}) = \begin{bmatrix} \frac{1}{2\sqrt{u}} & 0 \\ \frac{u}{\sqrt{u^2 + 3v^2}} & \frac{3v}{\sqrt{u^2 + 3v^2}} \\ 0 & \frac{1}{2\sqrt{v+2}} \end{bmatrix}$$

and

$$\mathbf{F}'(\mathbf{X}) = \begin{bmatrix} 2x & 2y & 4z \\ 2x & -2y & 0 \end{bmatrix}.$$

Then, from (6.2.22),

$$\begin{aligned} \mathbf{H}'(1, -1) &= \mathbf{F}'(1, 2, 1)\mathbf{G}'(1, -1) \\ &= \begin{bmatrix} 2 & 4 & 4 \\ 2 & -4 & 0 \end{bmatrix} \begin{bmatrix} \frac{1}{2} & 0 \\ \frac{1}{2} & -\frac{3}{2} \\ 0 & \frac{1}{2} \end{bmatrix} = \begin{bmatrix} 3 & -4 \\ -1 & 6 \end{bmatrix}. \end{aligned}$$

We can check this by expressing  $\mathbf{H}$  directly in terms of  $(u, v)$  as

$$\begin{aligned} \mathbf{H}(u, v) &= \begin{bmatrix} (\sqrt{u})^2 + (\sqrt{u^2 + 3v^2})^2 + 2(\sqrt{v+2})^2 \\ (\sqrt{u})^2 - (\sqrt{u^2 + 3v^2})^2 \end{bmatrix} \\ &= \begin{bmatrix} u + u^2 + 3v^2 + 2v + 4 \\ u - u^2 - 3v^2 \end{bmatrix} \end{aligned}$$

and differentiating to obtain

$$\mathbf{H}'(u, v) = \begin{bmatrix} 1 + 2u & 6v + 2 \\ 1 - 2u & -6v \end{bmatrix},$$

which yields

$$\mathbf{H}'(1, -1) = \begin{bmatrix} 3 & -4 \\ -1 & 6 \end{bmatrix},$$

as we saw before.

## 6.2 Exercises

1. Show that the following definitions are equivalent.

- (a)  $\mathbf{F} = (f_1, f_2, \dots, f_m)$  is continuous at  $\mathbf{X}_0$  if  $f_1, f_2, \dots, f_m$  are continuous at  $\mathbf{X}_0$ .

(b)  $\mathbf{F}$  is continuous at  $\mathbf{X}_0$  if for every  $\epsilon > 0$  there is a  $\delta > 0$  such that  $|\mathbf{F}(\mathbf{X}) - \mathbf{F}(\mathbf{X}_0)| < \epsilon$  if  $|\mathbf{X} - \mathbf{X}_0| < \delta$  and  $\mathbf{X} \in D_{\mathbf{F}}$ .

2. Verify that

$$\lim_{\mathbf{X} \rightarrow \mathbf{X}_0} \frac{\mathbf{F}(\mathbf{X}) - \mathbf{F}(\mathbf{X}_0) - \mathbf{F}'(\mathbf{X}_0)(\mathbf{X} - \mathbf{X}_0)}{|\mathbf{X} - \mathbf{X}_0|} = \mathbf{0}.$$

(a)  $\mathbf{F}(\mathbf{X}) = \begin{bmatrix} 3x + 4y \\ 2x - y \\ x + y \end{bmatrix}$ ,  $\mathbf{X}_0 = (x_0, y_0, z_0)$

(b)  $\mathbf{F}(\mathbf{X}) = \begin{bmatrix} 2x^2 + xy + 1 \\ xy \\ x^2 + y^2 \end{bmatrix}$ ,  $\mathbf{X}_0 = (1, -1)$

(c)  $\mathbf{F}(\mathbf{X}) = \begin{bmatrix} \sin(x + y) \\ \sin(y + z) \\ \sin(x + z) \end{bmatrix}$ ,  $\mathbf{X}_0 = (\pi/4, 0, \pi/4)$

3. Suppose that  $\mathbf{F} : \mathbb{R}^n \rightarrow \mathbb{R}^m$  and  $h : \mathbb{R}^n \rightarrow \mathbb{R}$  have the same domain and are continuous at  $\mathbf{X}_0$ . Show that the product  $h\mathbf{F} = (hf_1, hf_2, \dots, hf_m)$  is continuous at  $\mathbf{X}_0$ .
4. Suppose that  $\mathbf{F}$  and  $\mathbf{G}$  are transformations from  $\mathbb{R}^n$  to  $\mathbb{R}^m$  with common domain  $D$ . Show that if  $\mathbf{F}$  and  $\mathbf{G}$  are continuous at  $\mathbf{X}_0 \in D$ , then so are  $\mathbf{F} + \mathbf{G}$  and  $\mathbf{F} - \mathbf{G}$ .
5. Suppose that  $\mathbf{F} : \mathbb{R}^n \rightarrow \mathbb{R}^m$  is defined in a neighborhood of  $\mathbf{X}_0$  and continuous at  $\mathbf{X}_0$ ,  $\mathbf{G} : \mathbb{R}^k \rightarrow \mathbb{R}^n$  is defined in a neighborhood of  $\mathbf{U}_0$  and continuous at  $\mathbf{U}_0$ , and  $\mathbf{X}_0 = \mathbf{G}(\mathbf{U}_0)$ . Prove that the composite function  $\mathbf{H} = \mathbf{F} \circ \mathbf{G}$  is continuous at  $\mathbf{U}_0$ .
6. Prove: If  $\mathbf{F} : \mathbb{R}^n \rightarrow \mathbb{R}^m$  is continuous on a set  $S$ , then  $|\mathbf{F}|$  is continuous on  $S$ .
7. Prove: If  $\mathbf{F} : \mathbb{R}^n \rightarrow \mathbb{R}^m$  is continuous on a compact set  $S$ , then  $|\mathbf{F}|$  is bounded on  $S$ , and there are points  $\mathbf{X}_0$  and  $\mathbf{X}_1$  in  $S$  such that

$$|\mathbf{F}(\mathbf{X}_0)| \leq |\mathbf{F}(\mathbf{X})| \leq |\mathbf{F}(\mathbf{X}_1)|, \quad \mathbf{X} \in S;$$

that is,  $|\mathbf{F}|$  attains its infimum and supremum on  $S$ . HINT: Use Exercise 6.2.6.

8. Prove that a linear transformation  $\mathbf{L} : \mathbb{R}^n \rightarrow \mathbb{R}^m$  is continuous on  $\mathbb{R}^n$ . Do not use Theorem 6.2.8.
9. Let  $\mathbf{A}$  be an  $m \times n$  matrix.
- (a) Use Exercises 6.2.7 and 6.2.8 to show that the quantities

$$M(\mathbf{A}) = \max \left\{ \frac{|\mathbf{A}\mathbf{X}|}{|\mathbf{X}|} \mid \mathbf{X} \neq \mathbf{0} \right\} \quad \text{and} \quad m(\mathbf{A}) = \min \left\{ \frac{|\mathbf{A}\mathbf{X}|}{|\mathbf{X}|} \mid \mathbf{X} \neq \mathbf{0} \right\}$$

exist. HINT: Consider the function  $\mathbf{L}(\mathbf{Y}) = \mathbf{A}\mathbf{Y}$  on  $S = \{\mathbf{Y} \mid |\mathbf{Y}| = 1\}$ .



- (b) Show that  $M(\mathbf{A}) = \|\mathbf{A}\|$ .  
 (c) Prove: If  $n > m$  or  $n = m$  and  $\mathbf{A}$  is singular, then  $m(\mathbf{A}) = 0$ . (This requires a result from linear algebra on the existence of nontrivial solutions of  $\mathbf{A}\mathbf{X} = \mathbf{0}$ .)  
 (d) Prove: If  $n = m$  and  $\mathbf{A}$  is nonsingular, then

$$m(\mathbf{A})M(\mathbf{A}^{-1}) = m(\mathbf{A}^{-1})M(\mathbf{A}) = 1.$$

10. We say that  $\mathbf{F} : \mathbb{R}^n \rightarrow \mathbb{R}^m$  is *uniformly continuous on  $S$*  if each of its components is uniformly continuous on  $S$ . Prove: If  $\mathbf{F}$  is uniformly continuous on  $S$ , then for each  $\epsilon > 0$  there is a  $\delta > 0$  such that

$$|\mathbf{F}(\mathbf{X}) - \mathbf{F}(\mathbf{Y})| < \epsilon \quad \text{if} \quad |\mathbf{X} - \mathbf{Y}| < \delta \quad \text{and} \quad \mathbf{X}, \mathbf{Y} \in S.$$

11. Show that if  $\mathbf{F}$  is continuous on  $\mathbb{R}^n$  and  $\mathbf{F}(\mathbf{X} + \mathbf{Y}) = \mathbf{F}(\mathbf{X}) + \mathbf{F}(\mathbf{Y})$  for all  $\mathbf{X}$  and  $\mathbf{Y}$  in  $\mathbb{R}^n$ , then  $\mathbf{A}$  is linear. HINT: *The rational numbers are dense in the reals.*  
 12. Find  $\mathbf{F}'$  and  $J\mathbf{F}$ . Then find an affine transformation  $\mathbf{G}$  such that

$$\lim_{\mathbf{X} \rightarrow \mathbf{X}_0} \frac{\mathbf{F}(\mathbf{X}) - \mathbf{G}(\mathbf{X})}{\|\mathbf{X} - \mathbf{X}_0\|} = \mathbf{0}.$$

(a)  $\mathbf{F}(x, y, z) = \begin{bmatrix} x^2 + y + 2z \\ \cos(x + y + z) \\ e^{xyz} \end{bmatrix}, \quad \mathbf{X}_0 = (1, -1, 0)$

(b)  $\mathbf{F}(x, y) = \begin{bmatrix} e^x \cos y \\ e^x \sin y \end{bmatrix}, \quad \mathbf{X}_0 = (0, \pi/2)$

(c)  $\mathbf{F}(x, y, z) = \begin{bmatrix} x^2 - y^2 \\ y^2 - z^2 \\ z^2 - x^2 \end{bmatrix}, \quad \mathbf{X}_0 = (1, 1, 1)$

13. Find  $\mathbf{F}'$ .

(a)  $\mathbf{F}(x, y, z) = \begin{bmatrix} (x + y + z)e^x \\ (x^2 + y^2)e^{-x} \end{bmatrix} \quad \text{(b) } \mathbf{F}(x) = \begin{bmatrix} g_1(x) \\ g_2(x) \\ \vdots \\ g_n(x) \end{bmatrix}$

(c)  $\mathbf{F}(x, y, z) = \begin{bmatrix} e^x \sin yz \\ e^y \sin xz \\ e^z \sin xy \end{bmatrix}$

14. Find  $\mathbf{F}'$  and  $J\mathbf{F}$ .

(a)  $\mathbf{F}(r, \theta) = \begin{bmatrix} r \cos \theta \\ r \sin \theta \end{bmatrix} \quad \text{(b) } \mathbf{F}(r, \theta, \phi) = \begin{bmatrix} r \cos \theta \cos \phi \\ r \sin \theta \cos \phi \\ r \sin \phi \end{bmatrix}$

(c)  $\mathbf{F}(r, \theta, z) = \begin{bmatrix} r \cos \theta \\ r \sin \theta \\ z \end{bmatrix}$

15. Prove: If  $\mathbf{G}_1$  and  $\mathbf{G}_2$  are affine transformations and

$$\lim_{\mathbf{X} \rightarrow \mathbf{X}_0} \frac{\mathbf{G}_1(\mathbf{X}) - \mathbf{G}_2(\mathbf{X})}{|\mathbf{X} - \mathbf{X}_0|} = \mathbf{0},$$

then  $\mathbf{G}_1 = \mathbf{G}_2$ .

16. Prove Theorem 6.2.3.

17. Show that if  $\mathbf{F} : \mathbb{R}^n \rightarrow \mathbb{R}^m$  is differentiable at  $\mathbf{X}_0$  and  $\epsilon > 0$ , there is a  $\delta > 0$  such that

$$|\mathbf{F}(\mathbf{X}) - \mathbf{F}(\mathbf{X}_0)| \leq (\|\mathbf{F}'(\mathbf{X}_0)\| + \epsilon)|\mathbf{X} - \mathbf{X}_0| \quad \text{if } |\mathbf{X} - \mathbf{X}_0| < \delta.$$

Compare this with Lemma 6.2.5.

18. Suppose that  $\mathbf{F} : \mathbb{R}^n \rightarrow \mathbb{R}^n$  is differentiable at  $\mathbf{X}_0$  and  $\mathbf{F}'(\mathbf{X}_0)$  is nonsingular. Let

$$r = \frac{1}{\|[\mathbf{F}'(\mathbf{X}_0)]^{-1}\|}$$

and suppose that  $\epsilon > 0$ . Show that there is a  $\delta > 0$  such that

$$|\mathbf{F}(\mathbf{X}) - \mathbf{F}(\mathbf{X}_0)| \geq (r - \epsilon)|\mathbf{X} - \mathbf{X}_0| \quad \text{if } |\mathbf{X} - \mathbf{X}_0| < \delta.$$

Compare this with Lemma 6.2.6.

19. Prove: If  $\mathbf{L} : \mathbb{R}^n \rightarrow \mathbb{R}^m$  is defined by  $\mathbf{L}(\mathbf{X}) = \mathbf{A}(\mathbf{X})$ , where  $\mathbf{A}$  is nonsingular, then

$$|\mathbf{L}(\mathbf{X}) - \mathbf{L}(\mathbf{Y})| \geq \frac{1}{\|\mathbf{A}^{-1}\|} |\mathbf{X} - \mathbf{Y}|$$

for all  $\mathbf{X}$  and  $\mathbf{Y}$  in  $\mathbb{R}^n$ .

20. Use Theorem 6.2.8 to find  $\mathbf{H}'(\mathbf{U}_0)$ , where  $\mathbf{H}(\mathbf{U}) = \mathbf{F}(\mathbf{G}(\mathbf{U}))$ . Check your results by expressing  $\mathbf{H}$  directly in terms of  $\mathbf{U}$  and differentiating.

$$\text{(a) } \mathbf{F}(x, y, z) = \begin{bmatrix} x^2 + y^2 \\ z \\ x^2 + y^2 \end{bmatrix}, \quad \mathbf{G}(u, v, w) = \begin{bmatrix} w \cos u \sin v \\ w \sin u \sin v \\ w \cos v \end{bmatrix}, \quad \mathbf{U}_0 = (\pi/2, \pi/2, 2)$$

$$\text{(b) } \mathbf{F}(x, y) = \begin{bmatrix} x^2 - y^2 \\ y \\ x \end{bmatrix}, \quad \mathbf{G}(u, v) = \begin{bmatrix} v \cos u \\ v \sin u \end{bmatrix}, \quad \mathbf{U}_0 = (\pi/4, 3)$$

$$\text{(c) } \mathbf{F}(x, y, z) = \begin{bmatrix} 3x + 4y + 2z + 6 \\ 4x - 2y + z - 1 \\ -x + y + z - 2 \end{bmatrix}, \quad \mathbf{G}(u, v) = \begin{bmatrix} u - v \\ u + v \\ u - 2v \end{bmatrix},$$

$\mathbf{U}_0$  arbitrary

$$(d) \quad \mathbf{F}(x, y) = \begin{bmatrix} x + y \\ x - y \end{bmatrix}, \quad \mathbf{G}(u, v, w) = \begin{bmatrix} 2u - v + w \\ e^{u^2 - v^2} \end{bmatrix}, \quad \mathbf{U}_0 = (1, 1, -2)$$

$$(e) \quad \mathbf{F}(x, y) = \begin{bmatrix} x^2 + y^2 \\ x^2 - y^2 \end{bmatrix}, \quad \mathbf{G}(u, v) = \begin{bmatrix} e^u \cos v \\ e^u \sin v \end{bmatrix}, \quad \mathbf{U}_0 = (0, 0)$$

$$(f) \quad \mathbf{F}(x, y) = \begin{bmatrix} x + 2y \\ x - y^2 \\ x^2 + y \end{bmatrix}, \quad \mathbf{G}(u, v) = \begin{bmatrix} u + 2v \\ 2u - v^2 \end{bmatrix}, \quad \mathbf{U}_0 = (1, -2)$$

21. Suppose that  $\mathbf{F}$  and  $\mathbf{G}$  are continuously differentiable on  $\mathbb{R}^n$ , with values in  $\mathbb{R}^n$ , and let  $\mathbf{H} = \mathbf{F} \circ \mathbf{G}$ . Show that

$$\frac{\partial(h_1, h_2, \dots, h_n)}{\partial(u_1, u_2, \dots, u_n)} = \frac{\partial(f_1, f_2, \dots, f_n)}{\partial(x_1, x_2, \dots, x_n)} \frac{\partial(g_1, g_2, \dots, g_n)}{\partial(u_1, u_2, \dots, u_n)}.$$

Where should these Jacobians be evaluated?

22. Suppose that  $\mathbf{F} : \mathbb{R}^n \rightarrow \mathbb{R}^m$  and  $\bar{\mathbf{X}}$  is a limit point of  $D_{\mathbf{F}}$  contained in  $D_{\mathbf{F}}$ . Show that  $\mathbf{F}$  is continuous at  $\bar{\mathbf{X}}$  if and only if  $\lim_{k \rightarrow \infty} \mathbf{F}(\mathbf{X}_k) = \mathbf{F}(\bar{\mathbf{X}})$  whenever  $\{\mathbf{X}_k\}$  is a sequence of points in  $D_{\mathbf{F}}$  such that  $\lim_{k \rightarrow \infty} \mathbf{X}_k = \bar{\mathbf{X}}$ . HINT: See Exercise 5.2.15.
23. Suppose that  $\mathbf{F} : \mathbb{R}^n \rightarrow \mathbb{R}^m$  is continuous on a compact subset  $S$  of  $\mathbb{R}^n$ . Show that  $\mathbf{F}(S)$  is a compact subset of  $\mathbb{R}^m$ .

### 6.3 THE INVERSE FUNCTION THEOREM

So far our discussion of transformations has dealt mainly with properties that could just as well be defined and studied by considering the component functions individually. Now we turn to questions involving a transformation as a whole, that cannot be studied by regarding it as a collection of independent component functions.

In this section we restrict our attention to transformations from  $\mathbb{R}^n$  to itself. It is useful to interpret such transformations geometrically. If  $\mathbf{F} = (f_1, f_2, \dots, f_n)$ , we can think of the components of

$$\mathbf{F}(\mathbf{X}) = (f_1(\mathbf{X}), f_2(\mathbf{X}), \dots, f_n(\mathbf{X}))$$

as the coordinates of a point  $\mathbf{U} = \mathbf{F}(\mathbf{X})$  in another “copy” of  $\mathbb{R}^n$ . Thus,  $\mathbf{U} = (u_1, u_2, \dots, u_n)$ , with

$$u_1 = f_1(\mathbf{X}), \quad u_2 = f_2(\mathbf{X}), \quad \dots, \quad u_n = f_n(\mathbf{X}).$$

We say that  $\mathbf{F}$  maps  $\mathbf{X}$  to  $\mathbf{U}$ , and that  $\mathbf{U}$  is the image of  $\mathbf{X}$  under  $\mathbf{F}$ . Occasionally we will also write  $\partial u_i / \partial x_j$  to mean  $\partial f_i / \partial x_j$ . If  $S \subset D_{\mathbf{F}}$ , then the set

$$\mathbf{F}(S) = \{\mathbf{U} \mid \mathbf{U} = \mathbf{F}(\mathbf{X}), \mathbf{X} \in S\}$$

is the image of  $S$  under  $\mathbf{F}$ .

We will often denote the components of  $\mathbf{X}$  by  $x, y, \dots$ , and the components of  $\mathbf{U}$  by  $u, v, \dots$ .

**Example 6.3.1** If

$$\begin{bmatrix} u \\ v \end{bmatrix} = \mathbf{F}(x, y) = \begin{bmatrix} x^2 + y^2 \\ x^2 - y^2 \end{bmatrix},$$

then

$$u = f_1(x, y) = x^2 + y^2, \quad v = f_2(x, y) = x^2 - y^2,$$

and

$$\begin{aligned} u_x(x, y) &= \frac{\partial f_1(x, y)}{\partial x} = 2x, & u_y(x, y) &= \frac{\partial f_1(x, y)}{\partial y} = 2y, \\ v_x(x, y) &= \frac{\partial f_2(x, y)}{\partial x} = 2x, & v_y(x, y) &= \frac{\partial f_2(x, y)}{\partial y} = -2y. \end{aligned}$$

To find  $\mathbf{F}(\mathbb{R}^2)$ , we observe that

$$u + v = 2x^2, \quad u - v = 2y^2,$$

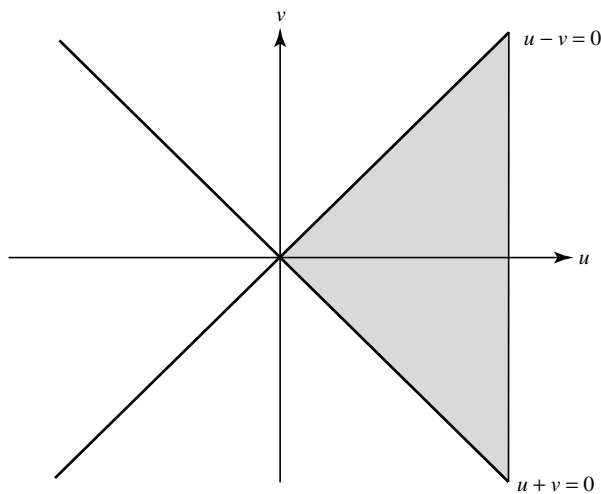
so

$$\mathbf{F}(\mathbb{R}^2) \subset T = \{(u, v) \mid u + v \geq 0, u - v \geq 0\},$$

which is the part of the  $uv$ -plane shaded in Figure 6.3.1. If  $(u, v) \in T$ , then

$$\mathbf{F}\left(\frac{\sqrt{u+v}}{2}, \frac{\sqrt{u-v}}{2}\right) = \begin{bmatrix} u \\ v \end{bmatrix},$$

so  $\mathbf{F}(\mathbb{R}^2) = T$ .



**Figure 6.3.1**

### Invertible Transformations

A transformation  $\mathbf{F}$  is *one-to-one*, or *invertible*, if  $\mathbf{F}(\mathbf{X}_1)$  and  $\mathbf{F}(\mathbf{X}_2)$  are distinct whenever  $\mathbf{X}_1$  and  $\mathbf{X}_2$  are distinct points of  $D_{\mathbf{F}}$ . In this case, we can define a function  $\mathbf{G}$  on the range

$$R(\mathbf{F}) = \{\mathbf{U} \mid \mathbf{U} = \mathbf{F}(\mathbf{X}) \text{ for some } \mathbf{X} \in D_{\mathbf{F}}\}$$

of  $\mathbf{F}$  by defining  $\mathbf{G}(\mathbf{U})$  to be the unique point in  $D_{\mathbf{F}}$  such that  $\mathbf{F}(\mathbf{U}) = \mathbf{U}$ . Then

$$D_{\mathbf{G}} = R(\mathbf{F}) \quad \text{and} \quad R(\mathbf{G}) = D_{\mathbf{F}}.$$

Moreover,  $\mathbf{G}$  is one-to-one,

$$\mathbf{G}(\mathbf{F}(\mathbf{X})) = \mathbf{X}, \quad \mathbf{X} \in D_{\mathbf{F}},$$

and

$$\mathbf{F}(\mathbf{G}(\mathbf{U})) = \mathbf{U}, \quad \mathbf{U} \in D_{\mathbf{G}}.$$

We say that  $\mathbf{G}$  is the *inverse* of  $\mathbf{F}$ , and write  $\mathbf{G} = \mathbf{F}^{-1}$ . The relation between  $\mathbf{F}$  and  $\mathbf{G}$  is symmetric; that is,  $\mathbf{F}$  is also the inverse of  $\mathbf{G}$ , and we write  $\mathbf{F} = \mathbf{G}^{-1}$ .

**Example 6.3.2** The linear transformation

$$\begin{bmatrix} u \\ v \end{bmatrix} = \mathbf{L}(x, y) = \begin{bmatrix} x - y \\ x + y \end{bmatrix} \quad (6.3.1)$$

maps  $(x, y)$  to  $(u, v)$ , where

$$\begin{aligned} u &= x - y, \\ v &= x + y. \end{aligned} \quad (6.3.2)$$

$\mathbf{L}$  is one-to-one and  $R(\mathbf{L}) = \mathbb{R}^2$ , since for each  $(u, v)$  in  $\mathbb{R}^2$  there is exactly one  $(x, y)$  such that  $\mathbf{L}(x, y) = (u, v)$ . This is so because the system (6.3.2) can be solved uniquely for  $(x, y)$  in terms of  $(u, v)$ :

$$\begin{aligned} x &= \frac{1}{2}(u + v), \\ y &= \frac{1}{2}(-u + v). \end{aligned} \quad (6.3.3)$$

Thus,

$$\mathbf{L}^{-1}(u, v) = \frac{1}{2} \begin{bmatrix} u + v \\ -u + v \end{bmatrix}.$$

**Example 6.3.3** The linear transformation

$$\begin{bmatrix} u \\ v \end{bmatrix} = \mathbf{L}_1(x, y) = \begin{bmatrix} x + y \\ 2x + 2y \end{bmatrix}$$

maps  $(x, y)$  onto  $(u, v)$ , where

$$\begin{aligned} u &= x + y, \\ v &= 2x + 2y. \end{aligned} \quad (6.3.4)$$

$L_1$  is not one-to-one, since every point on the line

$$x + y = c \quad (\text{constant})$$

is mapped onto the single point  $(c, 2c)$ . Hence,  $L_1$  does not have an inverse. ■

The crucial difference between the transformations of Examples 6.3.2 and 6.3.3 is that the matrix of  $L$  is nonsingular while the matrix of  $L_1$  is singular. Thus,  $L$  (see (6.3.1)) can be written as

$$\begin{bmatrix} u \\ v \end{bmatrix} = \begin{bmatrix} 1 & -1 \\ 1 & 1 \end{bmatrix} \begin{bmatrix} x \\ y \end{bmatrix}, \quad (6.3.5)$$

where the matrix has the inverse

$$\begin{bmatrix} \frac{1}{2} & \frac{1}{2} \\ -\frac{1}{2} & \frac{1}{2} \end{bmatrix}.$$

(Verify.) Multiplying both sides of (6.3.5) by this matrix yields

$$\begin{bmatrix} \frac{1}{2} & \frac{1}{2} \\ -\frac{1}{2} & \frac{1}{2} \end{bmatrix} \begin{bmatrix} u \\ v \end{bmatrix} = \begin{bmatrix} x \\ y \end{bmatrix},$$

which is equivalent to (6.3.3).

Since the matrix

$$\begin{bmatrix} 1 & 1 \\ 2 & 2 \end{bmatrix}$$

of  $L_1$  is singular, (6.3.4) cannot be solved uniquely for  $(x, y)$  in terms of  $(u, v)$ . In fact, it cannot be solved at all unless  $v = 2u$ .

The following theorem settles the question of invertibility of linear transformations from  $\mathbb{R}^n$  to  $\mathbb{R}^n$ . We leave the proof to you (Exercise 6.3.2).

**Theorem 6.3.1** *The linear transformation*

$$\mathbf{U} = \mathbf{L}(\mathbf{X}) = \mathbf{A}\mathbf{X} \quad (\mathbb{R}^n \rightarrow \mathbb{R}^n)$$

is invertible if and only if  $\mathbf{A}$  is nonsingular, in which case  $R(\mathbf{L}) = \mathbb{R}^n$  and

$$\mathbf{L}^{-1}(\mathbf{U}) = \mathbf{A}^{-1}\mathbf{U}.$$

## Polar Coordinates

We will now briefly review polar coordinates, which we will use in some of the following examples.

The coordinates of any point  $(x, y)$  can be written in infinitely many ways as

$$x = r \cos \theta, \quad y = r \sin \theta, \quad (6.3.6)$$

where

$$r^2 = x^2 + y^2$$

and, if  $r > 0$ ,  $\theta$  is the angle from the  $x$ -axis to the line segment from  $(0, 0)$  to  $(x, y)$ , measured counterclockwise (Figure 6.3.2).

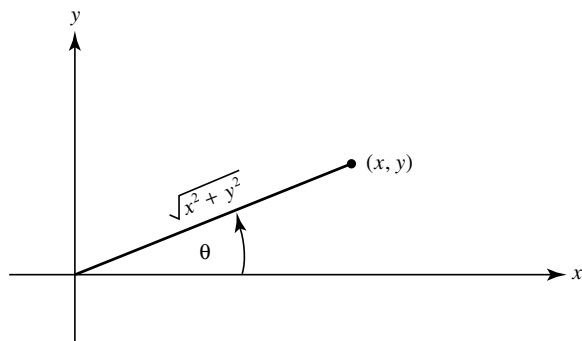


Figure 6.3.2

For each  $(x, y) \neq (0, 0)$  there are infinitely many values of  $\theta$ , differing by integral multiples of  $2\pi$ , that satisfy (6.3.6). If  $\theta$  is any of these values, we say that  $\theta$  is an *argument* of  $(x, y)$ , and write

$$\theta = \arg(x, y).$$

By itself, this does not define a function. However, if  $\phi$  is an arbitrary fixed number, then

$$\theta = \arg(x, y), \quad \phi \leq \theta < \phi + 2\pi,$$

does define a function, since every half-open interval  $[\phi, \phi + 2\pi)$  contains exactly one argument of  $(x, y)$ .

We do not define  $\arg(0, 0)$ , since (6.3.6) places no restriction on  $\theta$  if  $(x, y) = (0, 0)$  and therefore  $r = 0$ .

The transformation

$$\begin{bmatrix} r \\ \theta \end{bmatrix} = \mathbf{G}(x, y) = \begin{bmatrix} \sqrt{x^2 + y^2} \\ \arg(x, y) \end{bmatrix}, \quad \phi \leq \arg(x, y) < \phi + 2\pi,$$

is defined and one-to-one on

$$D_{\mathbf{G}} = \{(x, y) \mid (x, y) \neq (0, 0)\},$$

and its range is

$$R(\mathbf{G}) = \{(r, \theta) \mid r > 0, \phi \leq \theta < \phi + 2\pi\}.$$

For example, if  $\phi = 0$ , then

$$\mathbf{G}(1, 1) = \begin{bmatrix} \sqrt{2} \\ \frac{\pi}{4} \end{bmatrix},$$

since  $\pi/4$  is the unique argument of  $(1, 1)$  in  $[0, 2\pi)$ . If  $\phi = \pi$ , then

$$\mathbf{G}(1, 1) = \begin{bmatrix} \sqrt{2} \\ \frac{9\pi}{4} \end{bmatrix},$$

since  $9\pi/4$  is the unique argument of  $(1, 1)$  in  $[\pi, 3\pi)$ .

If  $\arg(x_0, y_0) = \phi$ , then  $(x_0, y_0)$  is on the half-line shown in Figure 6.3.3 and  $\mathbf{G}$  is not continuous at  $(x_0, y_0)$ , since every neighborhood of  $(x_0, y_0)$  contains points  $(x, y)$  for which the second component of  $\mathbf{G}(x, y)$  is arbitrarily close to  $\phi + 2\pi$ , while the second component of  $\mathbf{G}(x_0, y_0)$  is  $\phi$ . We will show later, however, that  $\mathbf{G}$  is continuous, in fact, continuously differentiable, on the plane with this half-line deleted.

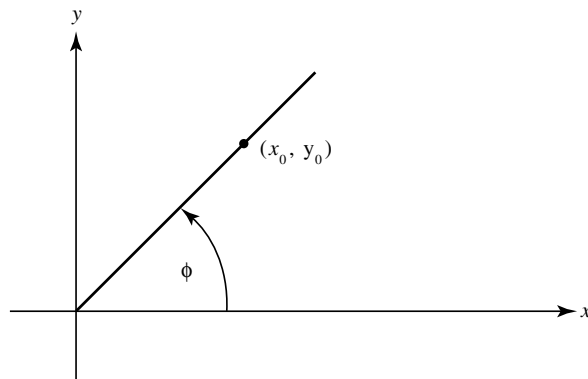


Figure 6.3.3

### Local Invertibility

A transformation  $\mathbf{F}$  may fail to be one-to-one, but be one-to-one on a subset  $S$  of  $D_{\mathbf{F}}$ . By this we mean that  $\mathbf{F}(\mathbf{X}_1)$  and  $\mathbf{F}(\mathbf{X}_2)$  are distinct whenever  $\mathbf{X}_1$  and  $\mathbf{X}_2$  are distinct points of  $S$ . In this case,  $\mathbf{F}$  is not invertible, but if  $\mathbf{F}_S$  is defined on  $S$  by

$$\mathbf{F}_S(\mathbf{X}) = \mathbf{F}(\mathbf{X}), \quad \mathbf{X} \in S,$$

and left undefined for  $\mathbf{X} \notin S$ , then  $\mathbf{F}_S$  is invertible. We say that  $\mathbf{F}_S$  is the *restriction of  $\mathbf{F}$  to  $S$* , and that  $\mathbf{F}_S^{-1}$  is the *inverse of  $\mathbf{F}$  restricted to  $S$* . The domain of  $\mathbf{F}_S^{-1}$  is  $\mathbf{F}(S)$ .



If  $\mathbf{F}$  is one-to-one on a neighborhood of  $\mathbf{X}_0$ , we say that  $\mathbf{F}$  is *locally invertible at  $\mathbf{X}_0$* . If this is true for every  $\mathbf{X}_0$  in a set  $S$ , then  $\mathbf{F}$  is *locally invertible on  $S$* .

**Example 6.3.4** The transformation

$$\begin{bmatrix} u \\ v \end{bmatrix} = \mathbf{F}(x, y) = \begin{bmatrix} x^2 - y^2 \\ 2xy \end{bmatrix} \quad (6.3.7)$$

is not one-to-one, since

$$\mathbf{F}(-x, -y) = \mathbf{F}(x, y). \quad (6.3.8)$$

It is one-to-one on  $S$  if and only if  $S$  does not contain any pair of distinct points of the form  $(x_0, y_0)$  and  $(-x_0, -y_0)$ ; (6.3.8) implies the necessity of this condition, and its sufficiency follows from the fact that if

$$\mathbf{F}(x_1, y_1) = \mathbf{F}(x_0, y_0), \quad (6.3.9)$$

then

$$(x_1, y_1) = (x_0, y_0) \quad \text{or} \quad (x_1, y_1) = (-x_0, -y_0). \quad (6.3.10)$$

To see this, suppose that (6.3.9) holds; then

$$x_1^2 - y_1^2 = x_0^2 - y_0^2 \quad (6.3.11)$$

and

$$x_1 y_1 = x_0 y_0. \quad (6.3.12)$$

Squaring both sides of (6.3.11) yields

$$x_1^4 - 2x_1^2 y_1^2 + y_1^4 = x_0^4 - 2x_0^2 y_0^2 + y_0^4.$$

This and (6.3.12) imply that

$$x_1^4 - x_0^4 = y_0^4 - y_1^4. \quad (6.3.13)$$

From (6.3.11),

$$x_1^2 - x_0^2 = y_1^2 - y_0^2. \quad (6.3.14)$$

Factoring (6.3.13) yields

$$(x_1^2 - x_0^2)(x_1^2 + x_0^2) = (y_0^2 - y_1^2)(y_0^2 + y_1^2).$$

If either side of (6.3.14) is nonzero, we can cancel to obtain

$$x_1^2 + x_0^2 = -y_0^2 - y_1^2,$$

which implies that  $x_0 = x_1 = y_0 = y_1 = 0$ , so (6.3.10) holds in this case. On the other hand, if both sides of (6.3.14) are zero, then

$$x_1 = \pm x_0, \quad y_1 = \pm y_0.$$

From (6.3.12), the same sign must be chosen in these equalities, which proves that (6.3.8) implies (6.3.10) in this case also.

We now see, for example, that  $\mathbf{F}$  is one-to-one on every set  $S$  of the form

$$S = \{(x, y) \mid ax + by > 0\},$$

where  $a$  and  $b$  are constants, not both zero. Geometrically,  $S$  is an open half-plane; that is, the set of points on one side of, but not on, the line

$$ax + by = 0$$

(Figure 6.3.4). Therefore,  $\mathbf{F}$  is locally invertible at every  $\mathbf{X}_0 \neq (0, 0)$ , since every such point lies in a half-plane of this form. However,  $\mathbf{F}$  is not locally invertible at  $(0, 0)$ . (Why not?) Thus,  $\mathbf{F}$  is locally invertible on the entire plane with  $(0, 0)$  removed.

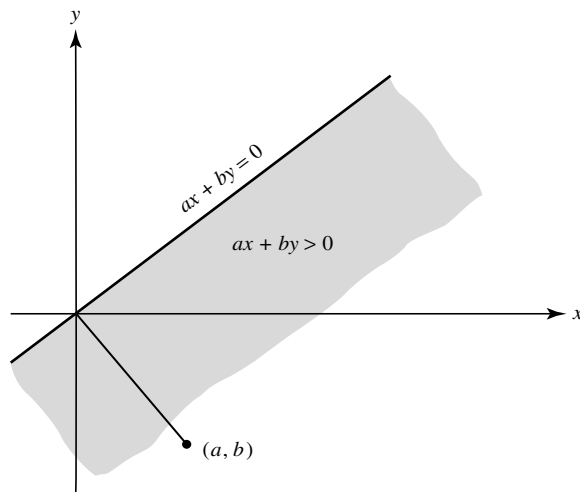


Figure 6.3.4

It is instructive to find  $\mathbf{F}_S^{-1}$  for a specific choice of  $S$ . Suppose that  $S$  is the open right half-plane:

$$S = \{(x, y) \mid x > 0\}. \quad (6.3.15)$$

Then  $\mathbf{F}(S)$  is the entire  $uv$ -plane except for the nonpositive  $u$  axis. To see this, note that every point in  $S$  can be written in polar coordinates as

$$x = r \cos \theta, \quad y = r \sin \theta, \quad r > 0, \quad -\frac{\pi}{2} < \theta < \frac{\pi}{2}.$$

Therefore, from (6.3.7),  $\mathbf{F}(x, y)$  has coordinates  $(u, v)$ , where

$$\begin{aligned} u &= x^2 - y^2 = r^2(\cos^2 \theta - \sin^2 \theta) = r^2 \cos 2\theta, \\ v &= 2xy = 2r^2 \cos \theta \sin \theta = r^2 \sin 2\theta. \end{aligned}$$

Every point in the  $uv$ -plane can be written in polar coordinates as

$$u = \rho \cos \alpha, \quad v = \rho \sin \alpha,$$

where either  $\rho = 0$  or

$$\rho = \sqrt{u^2 + v^2} > 0, \quad -\pi \leq \alpha < \pi,$$

and the points for which  $\rho = 0$  or  $\alpha = -\pi$  are of the form  $(u, 0)$ , with  $u \leq 0$  (Figure 6.3.5). If  $(u, v) = \mathbf{F}(x, y)$  for some  $(x, y)$  in  $S$ , then (6.3.15) implies that  $\rho > 0$  and  $-\pi < \alpha < \pi$ . Conversely, any point in the  $uv$ -plane with polar coordinates  $(\rho, \alpha)$  satisfying these conditions is the image under  $\mathbf{F}$  of the point

$$(x, y) = (\rho^{1/2} \cos \alpha/2, \rho^{1/2} \sin \alpha/2) \in S.$$

Thus,

$$\mathbf{F}_S^{-1}(u, v) = \begin{bmatrix} (u^2 + v^2)^{1/4} \cos(\arg(u, v)/2) \\ (u^2 + v^2)^{1/4} \sin(\arg(u, v)/2) \end{bmatrix}, \quad -\pi < \arg(u, v) < \pi.$$

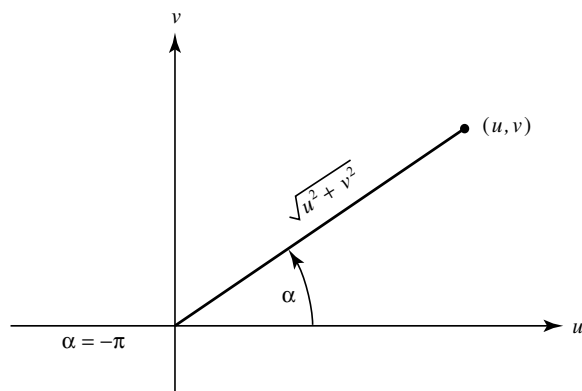


Figure 6.3.5

Because of (6.3.8),  $\mathbf{F}$  also maps the open left half-plane

$$S_1 = \{(x, y) \mid x < 0\}$$

onto  $\mathbf{F}(S)$ , and

$$\begin{aligned} \mathbf{F}_{S_1}^{-1}(u, v) &= \begin{bmatrix} (u^2 + v^2)^{1/4} \cos(\arg(u, v)/2) \\ (u^2 + v^2)^{1/4} \sin(\arg(u, v)/2) \end{bmatrix}, \quad \pi < \arg(u, v) < 3\pi, \\ &= -\mathbf{F}_S^{-1}(u, v). \end{aligned}$$

**Example 6.3.5** The transformation

$$\begin{bmatrix} u \\ v \end{bmatrix} = \mathbf{F}(x, y) = \begin{bmatrix} e^x \cos y \\ e^x \sin y \end{bmatrix} \quad (6.3.16)$$

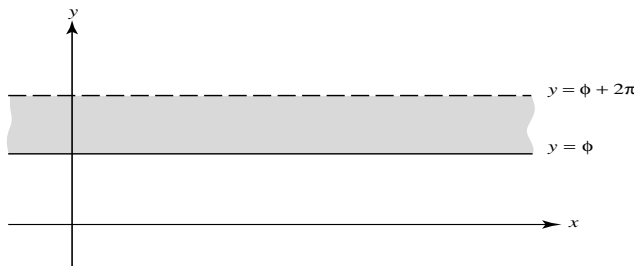
is not one-to-one, since

$$\mathbf{F}(x, y + 2k\pi) = \mathbf{F}(x, y) \quad (6.3.17)$$

if  $k$  is any integer. This transformation is one-to-one on a set  $S$  if and only if  $S$  does not contain any pair of points  $(x_0, y_0)$  and  $(x_0, y_0 + 2k\pi)$ , where  $k$  is a nonzero integer. This condition is necessary because of (6.3.17); we leave it to you to show that it is sufficient (Exercise 6.3.8). Therefore, for example,  $\mathbf{F}$  is one-to-one on

$$S_\phi = \{(x, y) \mid -\infty < x < \infty, \phi \leq y < \phi + 2\pi\} \quad (6.3.18)$$

where  $\phi$  is arbitrary. Geometrically,  $S_\phi$  is the infinite strip bounded by the lines  $y = \phi$  and  $y = \phi + 2\pi$ . The lower boundary is in  $S_\phi$ , but the upper is not (Figure 6.3.6). Since every point is in the interior of some such strip,  $\mathbf{F}$  is locally invertible on the entire plane.



**Figure 6.3.6**

The range of  $\mathbf{F}_{S_\phi}$  is the entire  $uv$ -plane except the origin, since if  $(u, v) \neq (0, 0)$ , then  $(u, v)$  can be written uniquely as

$$\begin{bmatrix} u \\ v \end{bmatrix} = \begin{bmatrix} \rho \cos \alpha \\ \rho \sin \alpha \end{bmatrix},$$

where

$$\rho > 0, \quad \phi \leq \alpha < \phi + 2\pi,$$

so  $(u, v)$  is the image under  $\mathbf{F}$  of

$$(x, y) = (\log \rho, \alpha) \in S.$$

The origin is not in  $R(\mathbf{F})$ , since

$$|\mathbf{F}(x, y)|^2 = (e^x \cos y)^2 + (e^x \sin y)^2 = e^{2x} \neq 0.$$

Finally,

$$\mathbf{F}_{S_\phi}^{-1}(u, v) = \begin{bmatrix} \log(u^2 + v^2)^{1/2} \\ \arg(u, v) \end{bmatrix}, \quad \phi \leq \arg(u, v) < \phi + 2\pi.$$

The domain of  $\mathbf{F}_{S_\phi}^{-1}$  is the entire  $uv$ -plane except for  $(0, 0)$ .

## Regular Transformations

The question of invertibility of an arbitrary transformation  $\mathbf{F} : \mathbb{R}^n \rightarrow \mathbb{R}^n$  is too general to have a useful answer. However, there is a useful and easily applicable sufficient condition which implies that one-to-one restrictions of continuously differentiable transformations have continuously differentiable inverses.

To motivate our study of this question, let us first consider the linear transformation

$$\mathbf{F}(\mathbf{X}) = \mathbf{A}\mathbf{X} = \begin{bmatrix} a_{11} & a_{12} & \cdots & a_{1n} \\ a_{21} & a_{22} & \cdots & a_{2n} \\ \vdots & \vdots & \ddots & \vdots \\ a_{n1} & a_{n2} & \cdots & a_{nn} \end{bmatrix} \begin{bmatrix} x_1 \\ x_2 \\ \vdots \\ x_n \end{bmatrix}.$$

From Theorem 6.3.1,  $\mathbf{F}$  is invertible if and only if  $\mathbf{A}$  is nonsingular, in which case  $R(\mathbf{F}) = \mathbb{R}^n$  and

$$\mathbf{F}^{-1}(\mathbf{U}) = \mathbf{A}^{-1}\mathbf{U}.$$

Since  $\mathbf{A}$  and  $\mathbf{A}^{-1}$  are the differential matrices of  $\mathbf{F}$  and  $\mathbf{F}^{-1}$ , respectively, we can say that a linear transformation is invertible if and only if its differential matrix  $\mathbf{F}'$  is nonsingular, in which case the differential matrix of  $\mathbf{F}^{-1}$  is given by

$$(\mathbf{F}^{-1})' = (\mathbf{F}')^{-1}.$$

Because of this, it is tempting to conjecture that if  $\mathbf{F} : \mathbb{R}^n \rightarrow \mathbb{R}^n$  is continuously differentiable and  $\mathbf{A}'(\mathbf{X})$  is nonsingular, or, equivalently,  $J\mathbf{F}(\mathbf{X}) \neq 0$ , for  $\mathbf{X}$  in a set  $S$ , then  $\mathbf{F}$  is one-to-one on  $S$ . However, this is false. For example, if

$$\mathbf{F}(x, y) = \begin{bmatrix} e^x \cos y \\ e^x \sin y \end{bmatrix},$$

then

$$J\mathbf{F}(x, y) = \begin{vmatrix} e^x \cos y & -e^x \sin y \\ e^x \sin y & e^x \cos y \end{vmatrix} = e^{2x} \neq 0, \quad (6.3.19)$$

but  $\mathbf{F}$  is not one-to-one on  $\mathbb{R}^2$  (Example 6.3.5). The best that can be said in general is that if  $\mathbf{F}$  is continuously differentiable and  $J\mathbf{F}(\mathbf{X}) \neq 0$  in an open set  $S$ , then  $\mathbf{F}$  is locally invertible on  $S$ , and the local inverses are continuously differentiable. This is part of the inverse function theorem, which we will prove presently. First, we need the following definition.

**Definition 6.3.2** A transformation  $\mathbf{F} : \mathbb{R}^n \rightarrow \mathbb{R}^n$  is *regular* on an open set  $S$  if  $\mathbf{F}$  is one-to-one and continuously differentiable on  $S$ , and  $J\mathbf{F}(\mathbf{X}) \neq 0$  if  $\mathbf{X} \in S$ . We will also say that  $\mathbf{F}$  is regular on an arbitrary set  $S$  if  $\mathbf{F}$  is regular on an open set containing  $S$ .

**Example 6.3.6** If

$$\mathbf{F}(x, y) = \begin{bmatrix} x - y \\ x + y \end{bmatrix}$$

(Example 6.3.2), then

$$J\mathbf{F}(x, y) = \begin{vmatrix} 1 & -1 \\ 1 & 1 \end{vmatrix} = 2,$$

so  $\mathbf{F}$  is one-to-one on  $\mathbb{R}^2$ . Hence,  $\mathbf{F}$  is regular on  $\mathbb{R}^2$ .

If

$$\mathbf{F}(x, y) = \begin{bmatrix} x + y \\ 2x + 2y \end{bmatrix}$$

(Example 6.3.3), then

$$J\mathbf{F}(x, y) = \begin{vmatrix} 1 & 1 \\ 2 & 2 \end{vmatrix} = 0,$$

so  $\mathbf{F}$  is not regular on any subset of  $\mathbb{R}^2$ .

If

$$\mathbf{F}(x, y) = \begin{bmatrix} x^2 - y^2 \\ 2xy \end{bmatrix}$$

(Example 6.3.4), then

$$J\mathbf{F}(x, y) = \begin{vmatrix} 2x & -2y \\ 2y & 2x \end{vmatrix} = 2(x^2 + y^2),$$

so  $\mathbf{F}$  is regular on any open set  $S$  on which  $\mathbf{F}$  is one-to-one, provided that  $(0, 0) \notin S$ . For example,  $\mathbf{F}$  is regular on the open half-plane  $\{(x, y) \mid x > 0\}$ , since we saw in Example 6.3.4 that  $\mathbf{F}$  is one-to-one on this half-plane.

If

$$\mathbf{F}(x, y) = \begin{bmatrix} e^x \cos y \\ e^x \sin y \end{bmatrix}$$

(Example 6.3.5), then  $J\mathbf{F}(x, y) = e^{2x}$  (see (6.3.19)), so  $\mathbf{F}$  is regular on any open set on which it is one-to-one. The interior of  $S_\phi$  in (6.3.18) is an example of such a set.

**Theorem 6.3.3** Suppose that  $\mathbf{F} : \mathbb{R}^n \rightarrow \mathbb{R}^n$  is regular on an open set  $S$ , and let  $\mathbf{G} = \mathbf{F}_S^{-1}$ . Then  $\mathbf{F}(S)$  is open,  $\mathbf{G}$  is continuously differentiable on  $\mathbf{F}(S)$ , and

$$\mathbf{G}'(\mathbf{U}) = (\mathbf{F}'(\mathbf{X}))^{-1}, \quad \text{where } \mathbf{U} = \mathbf{F}(\mathbf{X}).$$

Moreover, since  $\mathbf{G}$  is one-to-one on  $\mathbf{F}(S)$ ,  $\mathbf{G}$  is regular on  $\mathbf{F}(S)$ .

**Proof** We first show that if  $\mathbf{X}_0 \in S$ , then a neighborhood of  $\mathbf{F}(\mathbf{X}_0)$  is in  $\mathbf{F}(S)$ . This implies that  $\mathbf{F}(S)$  is open.

Since  $S$  is open, there is a  $\rho > 0$  such that  $\overline{B_\rho(\mathbf{X}_0)} \subset S$ . Let  $B$  be the boundary of  $B_\rho(\mathbf{X}_0)$ ; thus,

$$B = \{ \mathbf{X} \mid |\mathbf{X} - \mathbf{X}_0| = \rho \}. \quad (6.3.20)$$

The function

$$\sigma(\mathbf{X}) = |\mathbf{F}(\mathbf{X}) - \mathbf{F}(\mathbf{X}_0)|$$

is continuous on  $S$  and therefore on  $B$ , which is compact. Hence, by Theorem 5.2.12, there is a point  $\mathbf{X}_1$  in  $B$  where  $\sigma(\mathbf{X})$  attains its minimum value, say  $m$ , on  $B$ . Moreover,  $m > 0$ , since  $\mathbf{X}_1 \neq \mathbf{X}_0$  and  $\mathbf{F}$  is one-to-one on  $S$ . Therefore,

$$|\mathbf{F}(\mathbf{X}) - \mathbf{F}(\mathbf{X}_0)| \geq m > 0 \quad \text{if} \quad |\mathbf{X} - \mathbf{X}_0| = \rho. \quad (6.3.21)$$

The set

$$\{ \mathbf{U} \mid |\mathbf{U} - \mathbf{F}(\mathbf{X}_0)| < m/2 \}$$

is a neighborhood of  $\mathbf{F}(\mathbf{X}_0)$ . We will show that it is a subset of  $\mathbf{F}(S)$ . To see this, let  $\mathbf{U}$  be a fixed point in this set; thus,

$$|\mathbf{U} - \mathbf{F}(\mathbf{X}_0)| < m/2. \quad (6.3.22)$$

Consider the function

$$\sigma_1(\mathbf{X}) = |\mathbf{U} - \mathbf{F}(\mathbf{X})|^2,$$

which is continuous on  $S$ . Note that

$$\sigma_1(\mathbf{X}) \geq \frac{m^2}{4} \quad \text{if} \quad |\mathbf{X} - \mathbf{X}_0| = \rho, \quad (6.3.23)$$

since if  $|\mathbf{X} - \mathbf{X}_0| = \rho$ , then

$$\begin{aligned} |\mathbf{U} - \mathbf{F}(\mathbf{X})| &= |(\mathbf{U} - \mathbf{F}(\mathbf{X}_0)) + (\mathbf{F}(\mathbf{X}_0) - \mathbf{F}(\mathbf{X}))| \\ &\geq \left| |\mathbf{F}(\mathbf{X}_0) - \mathbf{F}(\mathbf{X})| - |\mathbf{U} - \mathbf{F}(\mathbf{X}_0)| \right| \\ &\geq m - \frac{m}{2} = \frac{m}{2}, \end{aligned}$$

from (6.3.21) and (6.3.22).

Since  $\sigma_1$  is continuous on  $S$ ,  $\sigma_1$  attains a minimum value  $\mu$  on the compact set  $\overline{B_\rho(\mathbf{X}_0)}$  (Theorem 5.2.12); that is, there is an  $\overline{\mathbf{X}}$  in  $\overline{B_\rho(\mathbf{X}_0)}$  such that

$$\sigma_1(\mathbf{X}) \geq \sigma_1(\overline{\mathbf{X}}) = \mu, \quad \mathbf{X} \in \overline{B_\rho(\mathbf{X}_0)}.$$

Setting  $\mathbf{X} = \mathbf{X}_0$ , we conclude from this and (6.3.22) that

$$\sigma_1(\overline{\mathbf{X}}) = \mu \leq \sigma_1(\mathbf{X}_0) < \frac{m^2}{4}.$$

Because of (6.3.20) and (6.3.23), this rules out the possibility that  $\overline{\mathbf{X}} \in B$ , so  $\overline{\mathbf{X}} \in B_\rho(\mathbf{X}_0)$ .

Now we want to show that  $\bar{\mu} = 0$ ; that is,  $\mathbf{U} = \mathbf{F}(\bar{\mathbf{X}})$ . To this end, we note that  $\sigma_1(\mathbf{X})$  can be written as

$$\sigma_1(\mathbf{X}) = \sum_{j=1}^n (u_j - f_j(\mathbf{X}))^2,$$

so  $\sigma_1$  is differentiable on  $B_p(\mathbf{X}_0)$ . Therefore, the first partial derivatives of  $\sigma_1$  are all zero at the local minimum point  $\bar{\mathbf{X}}$  (Theorem 5.3.11), so

$$\sum_{j=1}^n \frac{\partial f_j(\bar{\mathbf{X}})}{\partial x_i} (u_j - f_j(\bar{\mathbf{X}})) = 0, \quad 1 \leq i \leq n,$$

or, in matrix form,

$$\mathbf{F}'(\bar{\mathbf{X}})(\mathbf{U} - \mathbf{F}(\bar{\mathbf{X}})) = 0.$$

Since  $\mathbf{F}'(\bar{\mathbf{X}})$  is nonsingular this implies that  $\mathbf{U} = \mathbf{F}(\bar{\mathbf{X}})$  (Theorem 6.1.13). Thus, we have shown that every  $\mathbf{U}$  that satisfies (6.3.22) is in  $\mathbf{F}(S)$ . Therefore, since  $\mathbf{X}_0$  is an arbitrary point of  $S$ ,  $\mathbf{F}(S)$  is open.

Next, we show that  $\mathbf{G}$  is continuous on  $\mathbf{F}(S)$ . Suppose that  $\mathbf{U}_0 \in \mathbf{F}(S)$  and  $\mathbf{X}_0$  is the unique point in  $S$  such that  $\mathbf{F}(\mathbf{X}_0) = \mathbf{U}_0$ . Since  $\mathbf{F}'(\mathbf{X}_0)$  is invertible, Lemma 6.2.6 implies that there is a  $\lambda > 0$  and an open neighborhood  $N$  of  $\mathbf{X}_0$  such that  $N \subset S$  and

$$|\mathbf{F}(\mathbf{X}) - \mathbf{F}(\mathbf{X}_0)| \geq \lambda |\mathbf{X} - \mathbf{X}_0| \quad \text{if } \mathbf{X} \in N. \quad (6.3.24)$$

(Exercise 6.2.18 also implies this.) Since  $\mathbf{F}$  satisfies the hypotheses of the present theorem on  $N$ , the first part of this proof shows that  $\mathbf{F}(N)$  is an open set containing  $\mathbf{U}_0 = \mathbf{F}(\mathbf{X}_0)$ . Therefore, there is a  $\delta > 0$  such that  $\mathbf{X} = \mathbf{G}(\mathbf{U})$  is in  $N$  if  $\mathbf{U} \in B_\delta(\mathbf{U}_0)$ . Setting  $\mathbf{X} = \mathbf{G}(\mathbf{U})$  and  $\mathbf{X}_0 = \mathbf{G}(\mathbf{U}_0)$  in (6.3.24) yields

$$|\mathbf{F}(\mathbf{G}(\mathbf{U})) - \mathbf{F}(\mathbf{G}(\mathbf{U}_0))| \geq \lambda |\mathbf{G}(\mathbf{U}) - \mathbf{G}(\mathbf{U}_0)| \quad \text{if } \mathbf{U} \in B_\delta(\mathbf{U}_0).$$

Since  $\mathbf{F}(\mathbf{G}(\mathbf{U})) = \mathbf{U}$ , this can be rewritten as

$$|\mathbf{G}(\mathbf{U}) - \mathbf{G}(\mathbf{U}_0)| \leq \frac{1}{\lambda} |\mathbf{U} - \mathbf{U}_0| \quad \text{if } \mathbf{U} \in B_\delta(\mathbf{U}_0), \quad (6.3.25)$$

which means that  $\mathbf{G}$  is continuous at  $\mathbf{U}_0$ . Since  $\mathbf{U}_0$  is an arbitrary point in  $\mathbf{F}(S)$ , it follows that  $\mathbf{G}$  is continuous on  $\mathbf{F}(S)$ .

We will now show that  $\mathbf{G}$  is differentiable at  $\mathbf{U}_0$ . Since

$$\mathbf{G}(\mathbf{F}(\mathbf{X})) = \mathbf{X}, \quad \mathbf{X} \in S,$$

the chain rule (Theorem 6.2.8) implies that if  $\mathbf{G}$  is differentiable at  $\mathbf{U}_0$ , then

$$\mathbf{G}'(\mathbf{U}_0)\mathbf{F}'(\mathbf{X}_0) = \mathbf{I}$$



(Example 6.2.3). Therefore, if  $\mathbf{G}$  is differentiable at  $\mathbf{U}_0$ , the differential matrix of  $\mathbf{G}$  must be

$$\mathbf{G}'(\mathbf{U}_0) = [\mathbf{F}'(\mathbf{X}_0)]^{-1},$$

so to show that  $\mathbf{G}$  is differentiable at  $\mathbf{U}_0$ , we must show that if

$$\mathbf{H}(\mathbf{U}) = \frac{\mathbf{G}(\mathbf{U}) - \mathbf{G}(\mathbf{U}_0) - [\mathbf{F}'(\mathbf{X}_0)]^{-1}(\mathbf{U} - \mathbf{U}_0)}{|\mathbf{U} - \mathbf{U}_0|} \quad (\mathbf{U} \neq \mathbf{U}_0), \quad (6.3.26)$$

then

$$\lim_{\mathbf{U} \rightarrow \mathbf{U}_0} \mathbf{H}(\mathbf{U}) = \mathbf{0}. \quad (6.3.27)$$

Since  $\mathbf{F}$  is one-to-one on  $S$  and  $\mathbf{F}(\mathbf{G}(\mathbf{U})) = \mathbf{U}$ , it follows that if  $\mathbf{U} \neq \mathbf{U}_0$ , then  $\mathbf{G}(\mathbf{U}) \neq \mathbf{G}(\mathbf{U}_0)$ . Therefore, we can multiply the numerator and denominator of (6.3.26) by  $|\mathbf{G}(\mathbf{U}) - \mathbf{G}(\mathbf{U}_0)|$  to obtain

$$\begin{aligned} \mathbf{H}(\mathbf{U}) &= \frac{|\mathbf{G}(\mathbf{U}) - \mathbf{G}(\mathbf{U}_0)|}{|\mathbf{U} - \mathbf{U}_0|} \left( \frac{\mathbf{G}(\mathbf{U}) - \mathbf{G}(\mathbf{U}_0) - [\mathbf{F}'(\mathbf{X}_0)]^{-1}(\mathbf{U} - \mathbf{U}_0)}{|\mathbf{G}(\mathbf{U}) - \mathbf{G}(\mathbf{U}_0)|} \right) \\ &= -\frac{|\mathbf{G}(\mathbf{U}) - \mathbf{G}(\mathbf{U}_0)|}{|\mathbf{U} - \mathbf{U}_0|} [\mathbf{F}'(\mathbf{X}_0)]^{-1} \left( \frac{\mathbf{U} - \mathbf{U}_0 - \mathbf{F}'(\mathbf{X}_0)(\mathbf{G}(\mathbf{U}) - \mathbf{G}(\mathbf{U}_0))}{|\mathbf{G}(\mathbf{U}) - \mathbf{G}(\mathbf{U}_0)|} \right) \end{aligned}$$

if  $0 < |\mathbf{U} - \mathbf{U}_0| < \delta$ . Because of (6.3.25), this implies that

$$|\mathbf{H}(\mathbf{U})| \leq \frac{1}{\lambda} \|\mathbf{F}'(\mathbf{X}_0)\|^{-1} \left| \frac{\mathbf{U} - \mathbf{U}_0 - \mathbf{F}'(\mathbf{X}_0)(\mathbf{G}(\mathbf{U}) - \mathbf{G}(\mathbf{U}_0))}{|\mathbf{G}(\mathbf{U}) - \mathbf{G}(\mathbf{U}_0)|} \right|$$

if  $0 < |\mathbf{U} - \mathbf{U}_0| < \delta$ . Now let

$$\mathbf{H}_1(\mathbf{U}) = \frac{\mathbf{U} - \mathbf{U}_0 - \mathbf{F}'(\mathbf{X}_0)(\mathbf{G}(\mathbf{U}) - \mathbf{G}(\mathbf{U}_0))}{|\mathbf{G}(\mathbf{U}) - \mathbf{G}(\mathbf{U}_0)|}$$

To complete the proof of (6.3.27), we must show that

$$\lim_{\mathbf{U} \rightarrow \mathbf{U}_0} \mathbf{H}_1(\mathbf{U}) = \mathbf{0}. \quad (6.3.28)$$

Since  $\mathbf{F}$  is differentiable at  $\mathbf{X}_0$ , we know that if

$$\mathbf{H}_2(\mathbf{X}) = \lim_{\mathbf{X} \rightarrow \mathbf{X}_0} \frac{\mathbf{F}(\mathbf{X}) - \mathbf{F}(\mathbf{X}_0) - \mathbf{F}'(\mathbf{X}_0)(\mathbf{X} - \mathbf{X}_0)}{|\mathbf{X} - \mathbf{X}_0|},$$

then

$$\lim_{\mathbf{X} \rightarrow \mathbf{X}_0} \mathbf{H}_2(\mathbf{X}) = \mathbf{0}. \quad (6.3.29)$$

Since  $\mathbf{F}(\mathbf{G}(\mathbf{U})) = \mathbf{U}$  and  $\mathbf{X}_0 = \mathbf{G}(\mathbf{U}_0)$ ,

$$\mathbf{H}_1(\mathbf{U}) = \mathbf{H}_2(\mathbf{G}(\mathbf{U})).$$

Now suppose that  $\epsilon > 0$ . From (6.3.29), there is a  $\delta_1 > 0$  such that

$$|\mathbf{H}_2(\mathbf{X})| < \epsilon \quad \text{if} \quad 0 < |\mathbf{X} - \mathbf{X}_0| = |\mathbf{X} - \mathbf{G}(\mathbf{U}_0)| < \delta_1. \quad (6.3.30)$$

Since  $\mathbf{G}$  is continuous at  $\mathbf{U}_0$ , there is a  $\delta_2 \in (0, \delta)$  such that

$$|\mathbf{G}(\mathbf{U}) - \mathbf{G}(\mathbf{U}_0)| < \delta_1 \quad \text{if} \quad 0 < |\mathbf{U} - \mathbf{U}_0| < \delta_2.$$

This and (6.3.30) imply that

$$|\mathbf{H}_1(\mathbf{U})| = |\mathbf{H}_2(\mathbf{G}(\mathbf{U}))| < \epsilon \quad \text{if} \quad 0 < |\mathbf{U} - \mathbf{U}_0| < \delta_2.$$

Since this implies (6.3.28),  $\mathbf{G}$  is differentiable at  $\mathbf{X}_0$ .

Since  $\mathbf{U}_0$  is an arbitrary member of  $\mathbf{F}(N)$ , we can now drop the zero subscript and conclude that  $\mathbf{G}$  is continuous and differentiable on  $\mathbf{F}(N)$ , and

$$\mathbf{G}'(\mathbf{U}) = [\mathbf{F}'(\mathbf{X})]^{-1}, \quad \mathbf{U} \in \mathbf{F}(N).$$

To see that  $\mathbf{G}$  is *continuously differentiable* on  $\mathbf{F}(N)$ , we observe that by Theorem 6.1.14, each entry of  $\mathbf{G}'(\mathbf{U})$  (that is, each partial derivative  $\partial g_i(\mathbf{U})/\partial u_j$ ,  $1 \leq i, j \leq n$ ) can be written as the ratio, with nonzero denominator, of determinants with entries of the form

$$\frac{\partial f_r(\mathbf{G}(\mathbf{U}))}{\partial x_s}. \quad (6.3.31)$$

Since  $\partial f_r/\partial x_s$  is continuous on  $N$  and  $\mathbf{G}$  is continuous on  $\mathbf{F}(N)$ , Theorem 5.2.10 implies that (6.3.31) is continuous on  $\mathbf{F}(N)$ . Since a determinant is a continuous function of its entries, it now follows that the entries of  $\mathbf{G}'(\mathbf{U})$  are continuous on  $\mathbf{F}(N)$ . ■

## Branches of the Inverse

If  $\mathbf{F}$  is regular on an open set  $S$ , we say that  $\mathbf{F}_S^{-1}$  is a *branch of  $\mathbf{F}^{-1}$* . (This is a convenient terminology but is not meant to imply that  $\mathbf{F}$  actually has an inverse.) From this definition, it is possible to define a branch of  $\mathbf{F}^{-1}$  on a set  $T \subset R(\mathbf{F})$  if and only if  $T = \mathbf{F}(S)$ , where  $\mathbf{F}$  is regular on  $S$ . There may be open subsets of  $R(\mathbf{F})$  that do not have this property, and therefore no branch of  $\mathbf{F}^{-1}$  can be defined on them. It is also possible that  $T = \mathbf{F}(S_1) = \mathbf{F}(S_2)$ , where  $S_1$  and  $S_2$  are distinct subsets of  $D_{\mathbf{F}}$ . In this case, more than one branch of  $\mathbf{F}^{-1}$  is defined on  $T$ . Thus, we saw in Example 6.3.4 that two branches of  $\mathbf{F}^{-1}$  may be defined on a set  $T$ . In Example 6.3.5 infinitely many branches of  $\mathbf{F}^{-1}$  are defined on the same set.

It is useful to define branches of the argument. To do this, we think of the relationship between polar and rectangular coordinates in terms of the transformation

$$\begin{bmatrix} x \\ y \end{bmatrix} = \mathbf{F}(r, \theta) = \begin{bmatrix} r \cos \theta \\ r \sin \theta \end{bmatrix}, \quad (6.3.32)$$

where for the moment we regard  $r$  and  $\theta$  as rectangular coordinates of a point in an  $r\theta$ -plane. Let  $S$  be an open subset of the right half of this plane (that is,  $S \subset \{(r, \theta) \mid r > 0\}$ )

that does not contain any pair of points  $(r, \theta)$  and  $(r, \theta + 2k\pi)$ , where  $k$  is a nonzero integer. Then  $\mathbf{F}$  is one-to-one and continuously differentiable on  $S$ , with

$$\mathbf{F}'(r, \theta) = \begin{bmatrix} \cos \theta & -r \sin \theta \\ \sin \theta & r \cos \theta \end{bmatrix} \quad (6.3.33)$$

and

$$J\mathbf{F}(r, \theta) = r > 0, \quad (r, \theta) \in S. \quad (6.3.34)$$

Hence,  $\mathbf{F}$  is regular on  $S$ . Now let  $T = \mathbf{F}(S)$ , the set of points in the  $xy$ -plane with polar coordinates in  $S$ . Theorem 6.3.3 states that  $T$  is open and  $\mathbf{F}_S$  has a continuously differentiable inverse (which we denote by  $\mathbf{G}$ , rather than  $\mathbf{F}_S^{-1}$ , for typographical reasons)

$$\begin{bmatrix} r \\ \theta \end{bmatrix} = \mathbf{G}(x, y) = \begin{bmatrix} \sqrt{x^2 + y^2} \\ \arg_S(x, y) \end{bmatrix}, \quad (x, y) \in T,$$

where  $\arg_S(x, y)$  is the unique value of  $\arg(x, y)$  such that

$$(r, \theta) = \left( \sqrt{x^2 + y^2}, \arg_S(x, y) \right) \in S.$$

We say that  $\arg_S(x, y)$  is a *branch of the argument defined on  $T$* . Theorem 6.3.3 also implies that

$$\begin{aligned} \mathbf{G}'(x, y) &= [\mathbf{F}'(r, \theta)]^{-1} = \begin{bmatrix} \cos \theta & \sin \theta \\ -\frac{\sin \theta}{r} & \frac{\cos \theta}{r} \end{bmatrix} \quad (\text{see (6.3.33)}) \\ &= \begin{bmatrix} \frac{x}{\sqrt{x^2 + y^2}} & \frac{y}{\sqrt{x^2 + y^2}} \\ -\frac{y}{x^2 + y^2} & \frac{x}{x^2 + y^2} \end{bmatrix} \quad (\text{see (6.3.32)}). \end{aligned}$$

Therefore,

$$\frac{\partial \arg_S(x, y)}{\partial x} = -\frac{y}{x^2 + y^2}, \quad \frac{\partial \arg_S(x, y)}{\partial y} = \frac{x}{x^2 + y^2}. \quad (6.3.35)$$

A branch of  $\arg(x, y)$  can be defined on an open set  $T$  of the  $xy$ -plane if and only if the polar coordinates of the points in  $T$  form an open subset of the  $r\theta$ -plane that does not intersect the  $\theta$ -axis or contain any two points of the form  $(r, \theta)$  and  $(r, \theta + 2k\pi)$ , where  $k$  is a nonzero integer. No subset containing the origin  $(x, y) = (0, 0)$  has this property, nor does any deleted neighborhood of the origin (Exercise 6.3.14), so there are open sets on which no branch of the argument can be defined. However, if one branch can be defined on  $T$ , then so can infinitely many others. (Why?) All branches of  $\arg(x, y)$  have the same partial derivatives, given in (6.3.35).

**Example 6.3.7** The set

$$T = \{(x, y) \mid (x, y) \neq (x, 0) \text{ with } x \geq 0\},$$

which is the entire  $xy$ -plane with the nonnegative  $x$ -axis deleted, can be written as  $T = \mathbf{F}(S_k)$ , where  $\mathbf{F}$  is as in (6.3.32),  $k$  is an integer, and

$$S_k = \{(r, \theta) \mid r > 0, 2k\pi < \theta < 2(k+1)\pi\}.$$

For each integer  $k$ , we can define a branch  $\arg_{S_k}(x, y)$  of the argument in  $S_k$  by taking  $\arg_{S_k}(x, y)$  to be the value of  $\arg(x, y)$  that satisfies

$$2k\pi < \arg_{S_k}(x, y) < 2(k+1)\pi.$$

Each of these branches is continuously differentiable in  $T$ , with derivatives as given in (6.3.35), and

$$\arg_{S_k}(x, y) - \arg_{S_j}(x, y) = 2(k-j)\pi, \quad (x, y) \in T.$$

**Example 6.3.8** Returning to the transformation

$$\begin{bmatrix} u \\ v \end{bmatrix} = \mathbf{F}(x, y) = \begin{bmatrix} x^2 - y^2 \\ 2xy \end{bmatrix},$$

we now see from Example 6.3.4 that a branch  $\mathbf{G}$  of  $\mathbf{F}^{-1}$  can be defined on any subset  $T$  of the  $uv$ -plane on which a branch of  $\arg(u, v)$  can be defined, and  $\mathbf{G}$  has the form

$$\begin{bmatrix} x \\ y \end{bmatrix} = \mathbf{G}(u, v) = \begin{bmatrix} (u^2 + v^2)^{1/4} \cos(\arg(u, v)/2) \\ (u^2 + v^2)^{1/4} \sin(\arg(u, v)/2) \end{bmatrix}, \quad (u, v) \in T, \quad (6.3.36)$$

where  $\arg(u, v)$  is a branch of the argument defined on  $T$ . If  $\mathbf{G}_1$  and  $\mathbf{G}_2$  are different branches of  $\mathbf{F}^{-1}$  defined on the same set  $T$ , then  $\mathbf{G}_1 = \pm \mathbf{G}_2$ . (Why?)

From Theorem 6.3.3,

$$\begin{aligned} \mathbf{G}'(u, v) &= [\mathbf{F}'(x, y)]^{-1} = \begin{bmatrix} 2x & -2y \\ 2y & 2x \end{bmatrix}^{-1} \\ &= \frac{1}{2(x^2 + y^2)} \begin{bmatrix} x & y \\ -y & x \end{bmatrix}. \end{aligned}$$

Substituting for  $x$  and  $y$  in terms of  $u$  and  $v$  from (6.3.36), we find that

$$\frac{\partial x}{\partial u} = \frac{\partial y}{\partial v} = \frac{x}{2(x^2 + y^2)} = \frac{1}{2(u^2 + v^2)^{1/4}} \cos(\arg(u, v)/2) \quad (6.3.37)$$

and

$$\frac{\partial x}{\partial v} = -\frac{\partial y}{\partial u} = \frac{y}{2(x^2 + y^2)} = \frac{1}{2(u^2 + v^2)^{1/4}} \sin(\arg(u, v)/2). \quad (6.3.38)$$

It is essential that the same branch of the argument be used here and in (6.3.36). ■

We leave it to you (Exercise 6.3.16) to verify that (6.3.37) and (6.3.38) can also be obtained by differentiating (6.3.36) directly.

**Example 6.3.9** If

$$\begin{bmatrix} u \\ v \end{bmatrix} = \mathbf{F}(x, y) = \begin{bmatrix} e^x \cos y \\ e^x \sin y \end{bmatrix}$$

(Example 6.3.5), we can also define a branch  $\mathbf{G}$  of  $\mathbf{F}^{-1}$  on any subset  $T$  of the  $uv$ -plane on which a branch of  $\arg(u, v)$  can be defined, and  $\mathbf{G}$  has the form

$$\begin{bmatrix} x \\ y \end{bmatrix} = \mathbf{G}(u, v) = \begin{bmatrix} \log(u^2 + v^2)^{1/2} \\ \arg(u, v) \end{bmatrix}. \quad (6.3.39)$$

Since the branches of the argument differ by integral multiples of  $2\pi$ , (6.3.39) implies that if  $\mathbf{G}_1$  and  $\mathbf{G}_2$  are branches of  $\mathbf{F}^{-1}$ , both defined on  $T$ , then

$$\mathbf{G}_1(u, v) - \mathbf{G}_2(u, v) = \begin{bmatrix} 0 \\ 2k\pi \end{bmatrix} \quad (k = \text{integer}).$$

From Theorem 6.3.3,

$$\begin{aligned} \mathbf{G}'(u, v) &= [\mathbf{F}'(x, y)]^{-1} = \begin{bmatrix} e^x \cos y & -e^x \sin y \\ e^x \sin y & e^x \cos y \end{bmatrix}^{-1} \\ &= \begin{bmatrix} e^{-x} \cos y & e^{-x} \sin y \\ -e^{-x} \sin y & e^{-x} \cos y \end{bmatrix}. \end{aligned}$$

Substituting for  $x$  and  $y$  in terms of  $u$  and  $v$  from (6.3.39), we find that

$$\frac{\partial x}{\partial u} = \frac{\partial y}{\partial v} = e^{-x} \cos y = e^{-2x} u = \frac{u}{u^2 + v^2}$$

and

$$\frac{\partial x}{\partial v} = -\frac{\partial y}{\partial u} = e^{-x} \sin y = e^{-2x} v = \frac{v}{u^2 + v^2}.$$

### The Inverse Function Theorem

Examples 6.3.4 and 6.3.5 show that a continuously differentiable function  $\mathbf{F}$  may fail to have an inverse on a set  $S$  even if  $J\mathbf{F}(\mathbf{X}) \neq 0$  on  $S$ . However, the next theorem shows that in this case  $\mathbf{F}$  is locally invertible on  $S$ .

**Theorem 6.3.4 (The Inverse Function Theorem)** *Let  $\mathbf{F} : \mathbb{R}^n \rightarrow \mathbb{R}^n$  be continuously differentiable on an open set  $S$ , and suppose that  $J\mathbf{F}(\mathbf{X}) \neq 0$  on  $S$ . Then, if  $\mathbf{X}_0 \in S$ , there is an open neighborhood  $N$  of  $\mathbf{X}_0$  on which  $\mathbf{F}$  is regular. Moreover,  $\mathbf{F}(N)$  is open and  $\mathbf{G} = \mathbf{F}_N^{-1}$  is continuously differentiable on  $\mathbf{F}(N)$ , with*

$$\mathbf{G}'(\mathbf{U}) = [\mathbf{F}'(\mathbf{X})]^{-1} \quad (\text{where } \mathbf{U} = \mathbf{F}(\mathbf{X}), \quad \mathbf{U} \in \mathbf{F}(N)).$$

**Proof** Lemma 6.2.6 implies that there is an open neighborhood  $N$  of  $\mathbf{X}_0$  on which  $\mathbf{F}$  is one-to-one. The rest of the conclusions then follow from applying Theorem 6.3.3 to  $\mathbf{F}$  on  $N$ . ■

**Corollary 6.3.5** *If  $\mathbf{F}$  is continuously differentiable on a neighborhood of  $\mathbf{X}_0$  and  $J\mathbf{F}(\mathbf{X}_0) \neq 0$ , then there is an open neighborhood  $N$  of  $\mathbf{X}_0$  on which the conclusions of Theorem 6.3.4 hold.*

**Proof** By continuity, since  $J\mathbf{F}(\mathbf{X}_0) \neq 0$ ,  $J\mathbf{F}(\mathbf{X})$  is nonzero for all  $\mathbf{X}$  in some open neighborhood  $S$  of  $\mathbf{X}_0$ . Now apply Theorem 6.3.4. ■

**Example 6.3.10** Let  $\mathbf{X}_0 = (1, 2, 1)$  and

$$\begin{bmatrix} u \\ v \\ w \end{bmatrix} = \mathbf{F}(x, y, z) = \begin{bmatrix} x + y + (z - 1)^2 + 1 \\ y + z + (x - 1)^2 - 1 \\ z + x + (y - 2)^2 + 3 \end{bmatrix}.$$

Then

$$\mathbf{F}'(x, y, z) = \begin{bmatrix} 1 & 1 & 2z - 2 \\ 2x - 2 & 1 & 1 \\ 1 & 2y - 4 & 1 \end{bmatrix},$$

so

$$J\mathbf{F}(\mathbf{X}_0) = \begin{vmatrix} 1 & 1 & 0 \\ 0 & 1 & 1 \\ 1 & 0 & 1 \end{vmatrix} = 2.$$

In this case, it is difficult to describe  $N$  or find  $\mathbf{G} = \mathbf{F}_N^{-1}$  explicitly; however, we know that  $\mathbf{F}(N)$  is a neighborhood of  $\mathbf{U}_0 = \mathbf{F}(\mathbf{X}_0) = (4, 2, 5)$ , that  $\mathbf{G}(\mathbf{U}_0) = \mathbf{X}_0 = (1, 2, 1)$ , and that

$$\mathbf{G}'(\mathbf{U}_0) = [\mathbf{F}'(\mathbf{X}_0)]^{-1} = \begin{bmatrix} 1 & 1 & 0 \\ 0 & 1 & 1 \\ 1 & 0 & 1 \end{bmatrix}^{-1} = \frac{1}{2} \begin{bmatrix} 1 & -1 & 1 \\ 1 & 1 & -1 \\ -1 & 1 & 1 \end{bmatrix}.$$

Therefore,

$$\mathbf{G}(\mathbf{U}) = \begin{bmatrix} 1 \\ 2 \\ 1 \end{bmatrix} + \frac{1}{2} \begin{bmatrix} 1 & -1 & 1 \\ 1 & 1 & -1 \\ -1 & 1 & 1 \end{bmatrix} \begin{bmatrix} u - 4 \\ v - 2 \\ w - 5 \end{bmatrix} + \mathbf{E}(\mathbf{U}),$$

where

$$\lim_{\mathbf{U} \rightarrow (4, 2, 5)} \frac{\mathbf{E}(\mathbf{U})}{\sqrt{(u - 4)^2 + (v - 2)^2 + (w - 5)^2}} = \mathbf{0};$$

thus we have approximated  $\mathbf{G}$  near  $\mathbf{U}_0 = (4, 2, 5)$  by an affine transformation. ■

Theorem 6.3.4 and (6.3.34) imply that the transformation (6.3.32) is locally invertible on  $S = \{(r, \theta) \mid r > 0\}$ , which means that it is possible to define a branch of  $\arg(x, y)$  in a neighborhood of any point  $(x_0, y_0) \neq (0, 0)$ . It also implies, as we have already seen, that

the transformation (6.3.7) of Example 6.3.4 is locally invertible everywhere except at  $(0, 0)$ , where its Jacobian equals zero, and the transformation (6.3.16) of Example 6.3.5 is locally invertible everywhere.

### 6.3 Exercises

1. Prove: If  $\mathbf{F}$  is invertible, then  $\mathbf{F}^{-1}$  is unique.
2. Prove Theorem 6.3.1.
3. Prove: The linear transformation  $\mathbf{L}(\mathbf{X}) = \mathbf{A}\mathbf{X}$  cannot be one-to-one on any open set if  $\mathbf{A}$  is singular. HINT: Use Theorem 6.1.15.
4. Let

$$\mathbf{G}(x, y) = \begin{bmatrix} \sqrt{x^2 + y^2} \\ \arg(x, y) \end{bmatrix}, \quad \pi/2 \leq \arg(x, y) < 5\pi/2.$$

Find

- (a)  $\mathbf{G}(0, 1)$
  - (b)  $\mathbf{G}(1, 0)$
  - (c)  $\mathbf{G}(-1, 0)$
  - (d)  $\mathbf{G}(2, 2)$
  - (e)  $\mathbf{G}(-1, 1)$
5. Same as Exercise 6.3.4, except that  $-2\pi \leq \arg(x, y) < 0$ .
  6. (a) Prove: If  $f : \mathbb{R} \rightarrow \mathbb{R}$  is continuous and locally invertible on  $(a, b)$ , then  $f$  is invertible on  $(a, b)$ .  
(b) Give an example showing that the continuity assumption is needed in (a).
  7. Let

$$\mathbf{F}(x, y) = \begin{bmatrix} x^2 - y^2 \\ 2xy \end{bmatrix}$$

(Example 6.3.4) and

$$S = \{(x, y) \mid ax + by > 0\} \quad (a^2 + b^2 \neq 0).$$

Find  $\mathbf{F}(S)$  and  $\mathbf{F}_S^{-1}$ . If

$$S_1 = \{(x, y) \mid ax + by < 0\},$$

show that  $\mathbf{F}(S_1) = \mathbf{F}(S)$  and  $\mathbf{F}_{S_1}^{-1} = -\mathbf{F}_S^{-1}$ .

8. Show that the transformation

$$\begin{bmatrix} u \\ v \end{bmatrix} = \mathbf{F}(x, y) = \begin{bmatrix} e^x \cos y \\ e^x \sin y \end{bmatrix}$$

(Example 6.3.5) is one-to-one on any set  $S$  that does not contain any pair of points  $(x_0, y_0)$  and  $(x_0, y_0 + 2k\pi)$ , where  $k$  is a nonzero integer.

9. Suppose that  $\mathbf{F} : \mathbb{R}^n \rightarrow \mathbb{R}^n$  is continuous and invertible on a compact set  $S$ . Show that  $\mathbf{F}_S^{-1}$  is continuous. HINT: If  $\mathbf{F}_S^{-1}$  is not continuous at  $\bar{\mathbf{U}}$  in  $\mathbf{F}(S)$ , then there is an  $\epsilon_0 > 0$  and a sequence  $\{\mathbf{U}_k\}$  in  $\mathbf{F}(S)$  such that  $\lim_{k \rightarrow \infty} \mathbf{U}_k = \bar{\mathbf{U}}$  while

$$|\mathbf{F}_S^{-1}(\mathbf{U}_k) - \mathbf{F}_S^{-1}(\bar{\mathbf{U}})| \geq \epsilon_0, \quad k \geq 1.$$

Use Exercise 5.1.32 to obtain a contradiction.

10. Find  $\mathbf{F}^{-1}$  and  $(\mathbf{F}^{-1})'$ :

(a) 
$$\begin{bmatrix} u \\ v \end{bmatrix} = \mathbf{F}(x, y) = \begin{bmatrix} 4x + 2y \\ -3x + y \end{bmatrix}$$

(b) 
$$\begin{bmatrix} u \\ v \\ w \end{bmatrix} = \mathbf{F}(x, y, z) = \begin{bmatrix} -x + y + 2z \\ 3x + y - 4z \\ -x - y + 2z \end{bmatrix}$$

11. In addition to the assumptions of Theorem 6.3.3, suppose that all  $q$ th-order ( $q > 1$ ) partial derivatives of the components of  $\mathbf{F}$  are continuous on  $S$ . Show that all  $q$ th-order partial derivatives of  $\mathbf{F}_S^{-1}$  are continuous on  $\mathbf{F}(S)$ .

12. If

$$\begin{bmatrix} u \\ v \end{bmatrix} = \mathbf{F}(x, y) = \begin{bmatrix} x^2 + y^2 \\ x^2 - y^2 \end{bmatrix}$$

(Example 6.3.1), find four branches  $\mathbf{G}_1, \mathbf{G}_2, \mathbf{G}_3,$  and  $\mathbf{G}_4$  of  $\mathbf{F}^{-1}$  defined on

$$T_1 = \{(u, v) \mid u + v > 0, u - v > 0\},$$

and verify that  $\mathbf{G}'_i(u, v) = (\mathbf{F}'(x(u, v), y(u, v)))^{-1}, 1 \leq i \leq 4$ .

13. Suppose that  $\mathbf{A}$  is a nonsingular  $n \times n$  matrix and

$$\mathbf{U} = \mathbf{F}(\mathbf{X}) = \mathbf{A} \begin{bmatrix} x_1^2 \\ x_2^2 \\ \vdots \\ x_n^2 \end{bmatrix}.$$

- (a) Show that  $\mathbf{F}$  is regular on the set

$$S = \{\mathbf{X} \mid e_i x_i > 0, 1 \leq i \leq n\},$$

where  $e_i = \pm 1, 1 \leq i \leq n$ .

- (b) Find  $\mathbf{F}_S^{-1}(\mathbf{U})$ . (c) Find  $(\mathbf{F}_S^{-1})'(\mathbf{U})$ .

14. Let  $\theta(x, y)$  be a branch of  $\arg(x, y)$  defined on an open set  $S$ .

- (a) Show that  $\theta(x, y)$  cannot assume a local extreme value at any point of  $S$ .

- (b) Prove: If  $a \neq 0$  and the line segment from  $(x_0, y_0)$  to  $(ax_0, ay_0)$  is in  $S$ , then  $\theta(ax_0, ay_0) = \theta(x_0, y_0)$ .

- (c) Show that  $S$  cannot contain a subset of the form

$$A = \{(x, y) \mid 0 < r_1 \leq \sqrt{x^2 + y^2} \leq r_2\}.$$



(d) Show that no branch of  $\arg(x, y)$  can be defined on a deleted neighborhood of the origin.

15. Obtain Eqn. (6.3.35) formally by differentiating:

$$(a) \arg(x, y) = \cos^{-1} \frac{x}{\sqrt{x^2 + y^2}} \quad (b) \arg(x, y) = \sin^{-1} \frac{y}{\sqrt{x^2 + y^2}}$$

$$(c) \arg(x, y) = \tan^{-1} \frac{y}{x}$$

Where do these formulas come from? What is the disadvantage of using any one of them to define  $\arg(x, y)$ ?

16. For the transformation

$$\begin{bmatrix} u \\ v \end{bmatrix} = \mathbf{F}(x, y) = \begin{bmatrix} x^2 - y^2 \\ 2xy \end{bmatrix}$$

(Example 6.3.4), find a branch  $\mathbf{G}$  of  $\mathbf{F}^{-1}$  defined on  $T = \{(u, v) \mid au + bv > 0\}$ . Find  $\mathbf{G}'$  by means of the formula  $\mathbf{G}'(\mathbf{U}) = [\mathbf{F}'(\mathbf{X})]^{-1}$  of Theorem 6.3.3, and also by direct differentiation with respect to  $u$  and  $v$ .

17. A transformation

$$\mathbf{F}(x, y) = \begin{bmatrix} u(x, y) \\ v(x, y) \end{bmatrix}$$

is *analytic* on a set  $S$  if it is continuously differentiable and

$$u_x = v_y, \quad u_y = -v_x$$

on  $S$ . Prove: If  $\mathbf{F}$  is analytic and regular on  $S$ , then  $\mathbf{F}_S^{-1}$  is analytic on  $\mathbf{F}(S)$ ; that is,  $x_u = u_v$  and  $x_v = -u_u$ .

18. Prove: If  $\mathbf{U} = \mathbf{F}(\mathbf{X})$  and  $\mathbf{X} = \mathbf{G}(\mathbf{U})$  are inverse functions, then

$$\frac{\partial(u_1, u_2, \dots, u_n)}{\partial(x_1, x_2, \dots, x_n)} \frac{\partial(x_1, x_2, \dots, x_n)}{\partial(u_1, u_2, \dots, u_n)} = 1.$$

Where should the Jacobians be evaluated?

19. Give an example of a transformation  $\mathbf{F} : \mathbb{R}^n \rightarrow \mathbb{R}^n$  that is invertible but not regular on  $\mathbb{R}^n$ .

20. Find an affine transformation  $\mathbf{A}$  that so well approximates the branch  $\mathbf{G}$  of  $\mathbf{F}^{-1}$  defined near  $\mathbf{U}_0 = \mathbf{F}(\mathbf{X}_0)$  that

$$\lim_{\mathbf{U} \rightarrow \mathbf{U}_0} \frac{\mathbf{G}(\mathbf{U}) - \mathbf{A}(\mathbf{U})}{|\mathbf{U} - \mathbf{U}_0|} = \mathbf{0}.$$

$$(a) \begin{bmatrix} u \\ v \end{bmatrix} = \mathbf{F}(x, y) = \begin{bmatrix} x^4 y^5 - 4x \\ x^3 y^2 - 3y \end{bmatrix}, \quad \mathbf{X}_0 = (1, -1)$$

(b)  $\begin{bmatrix} u \\ v \end{bmatrix} = \mathbf{F}(x, y) = \begin{bmatrix} x^2y + xy \\ 2xy + xy^2 \end{bmatrix}, \quad \mathbf{X}_0 = (1, 1)$

(c)  $\begin{bmatrix} u \\ v \\ w \end{bmatrix} = \mathbf{F}(x, y, z) = \begin{bmatrix} 2x^2y + x^3 + z \\ x^3 + yz \\ x + y + z \end{bmatrix}, \quad \mathbf{X} = (0, 1, 1)$

(d)  $\begin{bmatrix} u \\ v \\ w \end{bmatrix} = \mathbf{F}(x, y, z) = \begin{bmatrix} x \cos y \cos z \\ x \sin y \cos z \\ x \sin z \end{bmatrix}, \quad \mathbf{X}_0 = (1, \pi/2, \pi)$

21. If  $\mathbf{F}$  is defined by

$$\begin{bmatrix} x \\ y \\ z \end{bmatrix} = \mathbf{F}(r, \theta, \phi) = \begin{bmatrix} r \cos \theta \cos \phi \\ r \sin \theta \cos \phi \\ r \sin \phi \end{bmatrix}$$

and  $\mathbf{G}$  is a branch of  $\mathbf{F}^{-1}$ , find  $\mathbf{G}'$  in terms of  $r, \theta,$  and  $\phi$ . HINT: See Exercise 6.2.14(b).

22. If  $\mathbf{F}$  is defined by

$$\begin{bmatrix} x \\ y \\ z \end{bmatrix} = \mathbf{F}(r, \theta, z) = \begin{bmatrix} r \cos \theta \\ r \sin \theta \\ z \end{bmatrix}$$

and  $\mathbf{G}$  is a branch of  $\mathbf{F}^{-1}$ , find  $\mathbf{G}'$  in terms of  $r, \theta,$  and  $z$ . HINT: See Exercise 6.2.14(c).

23. Suppose that  $\mathbf{F} : \mathbb{R}^n \rightarrow \mathbb{R}^n$  is regular on a compact set  $T$ . Show that  $\mathbf{F}(\partial T) = \partial \mathbf{F}(T)$ ; that is, boundary points map to boundary points. HINT: Use Exercise 6.2.23 and Theorem 6.3.3 to show that  $\partial \mathbf{F}(T) \subset \mathbf{F}(\partial T)$ . Then apply this result with  $\mathbf{F}$  and  $T$  replaced by  $\mathbf{F}^{-1}$  and  $\mathbf{F}(T)$  to show that  $\mathbf{F}(\partial T) \subset \partial \mathbf{F}(T)$ .

### 6.4 THE IMPLICIT FUNCTION THEOREM

In this section we consider transformations from  $\mathbb{R}^{n+m}$  to  $\mathbb{R}^m$ . It will be convenient to denote points in  $\mathbb{R}^{n+m}$  by

$$(\mathbf{X}, \mathbf{U}) = (x_1, x_2, \dots, x_n, u_1, u_2, \dots, u_m).$$

We will often denote the components of  $\mathbf{X}$  by  $x, y, \dots$ , and the components of  $\mathbf{U}$  by  $u, v, \dots$ .

To motivate the problem we are interested in, we first ask whether the linear system of  $m$  equations in  $m + n$  variables

$$\begin{aligned} a_{11}x_1 + a_{12}x_2 + \dots + a_{1n}x_n + b_{11}u_1 + b_{12}u_2 + \dots + b_{1m}u_m &= 0 \\ a_{21}x_1 + a_{22}x_2 + \dots + a_{2n}x_n + b_{21}u_1 + b_{22}u_2 + \dots + b_{2m}u_m &= 0 \\ &\vdots \\ a_{m1}x_1 + a_{m2}x_2 + \dots + a_{mn}x_n + b_{m1}u_1 + b_{m2}u_2 + \dots + b_{mm}u_m &= 0 \end{aligned} \tag{6.4.1}$$

determines  $u_1, u_2, \dots, u_m$  uniquely in terms of  $x_1, x_2, \dots, x_n$ . By rewriting the system in matrix form as

$$\mathbf{AX} + \mathbf{BU} = \mathbf{0},$$

where

$$\mathbf{A} = \begin{bmatrix} a_{11} & a_{12} & \cdots & a_{1n} \\ a_{21} & a_{22} & \cdots & a_{2n} \\ \vdots & \vdots & \ddots & \vdots \\ a_{m1} & a_{m2} & \cdots & a_{mn} \end{bmatrix}, \quad \mathbf{B} = \begin{bmatrix} b_{11} & b_{12} & \cdots & b_{1m} \\ b_{21} & b_{22} & \cdots & b_{2m} \\ \vdots & \vdots & \ddots & \vdots \\ b_{m1} & b_{m2} & \cdots & b_{mm} \end{bmatrix},$$

$$\mathbf{X} = \begin{bmatrix} x_1 \\ x_2 \\ \vdots \\ x_n \end{bmatrix}, \quad \text{and} \quad \mathbf{U} = \begin{bmatrix} u_1 \\ u_2 \\ \vdots \\ u_m \end{bmatrix},$$

we see that (6.4.1) can be solved uniquely for  $\mathbf{U}$  in terms of  $\mathbf{X}$  if the square matrix  $\mathbf{B}$  is nonsingular. In this case the solution is

$$\mathbf{U} = -\mathbf{B}^{-1}\mathbf{AX}.$$

For our purposes it is convenient to restate this: If

$$\mathbf{F}(\mathbf{X}, \mathbf{U}) = \mathbf{AX} + \mathbf{BU}, \quad (6.4.2)$$

where  $\mathbf{B}$  is nonsingular, then the system

$$\mathbf{F}(\mathbf{X}, \mathbf{U}) = \mathbf{0}$$

determines  $\mathbf{U}$  as a function of  $\mathbf{X}$ , for all  $\mathbf{X}$  in  $\mathbb{R}^n$ .

Notice that  $\mathbf{F}$  in (6.4.2) is a linear transformation. If  $\mathbf{F}$  is a more general transformation from  $\mathbb{R}^{n+m}$  to  $\mathbb{R}^m$ , we can still ask whether the system

$$\mathbf{F}(\mathbf{X}, \mathbf{U}) = \mathbf{0},$$

or, in terms of components,

$$\begin{aligned} f_1(x_1, x_2, \dots, x_n, u_1, u_2, \dots, u_m) &= 0 \\ f_2(x_1, x_2, \dots, x_n, u_1, u_2, \dots, u_m) &= 0 \\ &\vdots \\ f_m(x_1, x_2, \dots, x_n, u_1, u_2, \dots, u_m) &= 0, \end{aligned}$$

can be solved for  $\mathbf{U}$  in terms of  $\mathbf{X}$ . However, the situation is now more complicated, even if  $m = 1$ . For example, suppose that  $m = 1$  and

$$f(x, y, u) = 1 - x^2 - y^2 - u^2.$$

If  $x^2 + y^2 > 1$ , then no value of  $u$  satisfies

$$f(x, y, u) = 0. \quad (6.4.3)$$

However, infinitely many functions  $u = u(x, y)$  satisfy (6.4.3) on the set

$$S = \{(x, y) \mid x^2 + y^2 \leq 1\}.$$

They are of the form

$$u(x, y) = \epsilon(x, y)\sqrt{1 - x^2 - y^2},$$

where  $\epsilon(x, y)$  can be chosen arbitrarily, for each  $(x, y)$  in  $S$ , to be 1 or  $-1$ . We can narrow the choice of functions to two by requiring that  $u$  be continuous on  $S$ ; then

$$u(x, y) = \sqrt{1 - x^2 - y^2} \quad (6.4.4)$$

or

$$u(x, y) = -\sqrt{1 - x^2 - y^2}.$$

We can define a unique continuous solution  $u$  of (6.4.3) by specifying its value at a single interior point of  $S$ . For example, if we require that

$$u\left(\frac{1}{\sqrt{3}}, \frac{1}{\sqrt{3}}\right) = \frac{1}{\sqrt{3}},$$

then  $u$  must be as defined by (6.4.4).

The question of whether an arbitrary system

$$\mathbf{F}(\mathbf{X}, \mathbf{U}) = \mathbf{0}$$

determines  $\mathbf{U}$  as a function of  $\mathbf{X}$  is too general to have a useful answer. However, there is a theorem, the implicit function theorem, that answers this question affirmatively in an important special case. To facilitate the statement of this theorem, we partition the differential matrix of  $\mathbf{F} : \mathbb{R}^{n+m} \rightarrow \mathbb{R}^m$ :

$$\mathbf{F}' = \left[ \begin{array}{cccc|cccc} \frac{\partial f_1}{\partial x_1} & \frac{\partial f_1}{\partial x_2} & \cdots & \frac{\partial f_1}{\partial x_n} & \frac{\partial f_1}{\partial u_1} & \frac{\partial f_1}{\partial u_2} & \cdots & \frac{\partial f_1}{\partial u_m} \\ \frac{\partial f_2}{\partial x_1} & \frac{\partial f_2}{\partial x_2} & \cdots & \frac{\partial f_2}{\partial x_n} & \frac{\partial f_2}{\partial u_1} & \frac{\partial f_2}{\partial u_2} & \cdots & \frac{\partial f_2}{\partial u_m} \\ \vdots & \vdots & \ddots & \vdots & \vdots & \vdots & \ddots & \vdots \\ \frac{\partial f_m}{\partial x_1} & \frac{\partial f_m}{\partial x_2} & \cdots & \frac{\partial f_m}{\partial x_n} & \frac{\partial f_m}{\partial u_1} & \frac{\partial f_m}{\partial u_2} & \cdots & \frac{\partial f_m}{\partial u_m} \end{array} \right] \quad (6.4.5)$$

or

$$\mathbf{F}' = [\mathbf{F}_X, \mathbf{F}_U],$$

where  $\mathbf{F}_X$  is the submatrix to the left of the dashed line in (6.4.5) and  $\mathbf{F}_U$  is to the right.

For the linear transformation (6.4.2),  $\mathbf{F}_X = \mathbf{A}$  and  $\mathbf{F}_U = \mathbf{B}$ , and we have seen that the system  $\mathbf{F}(\mathbf{X}, \mathbf{U}) = \mathbf{0}$  defines  $\mathbf{U}$  as a function of  $\mathbf{X}$  for all  $\mathbf{X}$  in  $\mathbb{R}^n$  if  $\mathbf{F}_U$  is nonsingular. The next theorem shows that a related result holds for more general transformations.

**Theorem 6.4.1 (The Implicit Function Theorem)** Suppose that  $\mathbf{F} : \mathbb{R}^{n+m} \rightarrow \mathbb{R}^m$  is continuously differentiable on an open set  $S$  of  $\mathbb{R}^{n+m}$  containing  $(\mathbf{X}_0, \mathbf{U}_0)$ . Let  $\mathbf{F}(\mathbf{X}_0, \mathbf{U}_0) = \mathbf{0}$ , and suppose that  $\mathbf{F}_U(\mathbf{X}_0, \mathbf{U}_0)$  is nonsingular. Then there is a neighborhood  $M$  of  $(\mathbf{X}_0, \mathbf{U}_0)$ , contained in  $S$ , on which  $\mathbf{F}_U(\mathbf{X}, \mathbf{U})$  is nonsingular and a neighborhood  $N$  of  $\mathbf{X}_0$  in  $\mathbb{R}^n$  on which a unique continuously differentiable transformation  $\mathbf{G} : \mathbb{R}^n \rightarrow \mathbb{R}^m$  is defined, such that  $\mathbf{G}(\mathbf{X}_0) = \mathbf{U}_0$  and

$$(\mathbf{X}, \mathbf{G}(\mathbf{X})) \in M \quad \text{and} \quad \mathbf{F}(\mathbf{X}, \mathbf{G}(\mathbf{X})) = \mathbf{0} \quad \text{if} \quad \mathbf{X} \in N. \quad (6.4.6)$$

Moreover,

$$\mathbf{G}'(\mathbf{X}) = -[\mathbf{F}_U(\mathbf{X}, \mathbf{G}(\mathbf{X}))]^{-1} \mathbf{F}_X(\mathbf{X}, \mathbf{G}(\mathbf{X})), \quad \mathbf{X} \in N. \quad (6.4.7)$$

**Proof** Define  $\Phi : \mathbb{R}^{n+m} \rightarrow \mathbb{R}^{n+m}$  by

$$\Phi(\mathbf{X}, \mathbf{U}) = \begin{bmatrix} x_1 \\ x_2 \\ \vdots \\ x_n \\ f_1(\mathbf{X}, \mathbf{U}) \\ f_2(\mathbf{X}, \mathbf{U}) \\ \vdots \\ f_m(\mathbf{X}, \mathbf{U}) \end{bmatrix} \quad (6.4.8)$$

or, in “horizontal” notation by

$$\Phi(\mathbf{X}, \mathbf{U}) = (\mathbf{X}, \mathbf{F}(\mathbf{X}, \mathbf{U})). \quad (6.4.9)$$

Then  $\Phi$  is continuously differentiable on  $S$  and, since  $\mathbf{F}(\mathbf{X}_0, \mathbf{U}_0) = \mathbf{0}$ ,

$$\Phi(\mathbf{X}_0, \mathbf{U}_0) = (\mathbf{X}_0, \mathbf{0}). \quad (6.4.10)$$

The differential matrix of  $\Phi$  is

$$\Phi' = \begin{bmatrix} 1 & 0 & \cdots & 0 & 0 & 0 & \cdots & 0 \\ 0 & 1 & \cdots & 0 & 0 & 0 & \cdots & 0 \\ \vdots & \vdots & \ddots & \vdots & \vdots & \vdots & \ddots & \vdots \\ 0 & 0 & \cdots & 1 & 0 & 0 & \cdots & 0 \\ \frac{\partial f_1}{\partial x_1} & \frac{\partial f_1}{\partial x_2} & \cdots & \frac{\partial f_1}{\partial x_n} & \frac{\partial f_1}{\partial u_1} & \frac{\partial f_1}{\partial u_2} & \cdots & \frac{\partial f_1}{\partial u_m} \\ \frac{\partial f_2}{\partial x_1} & \frac{\partial f_2}{\partial x_2} & \cdots & \frac{\partial f_2}{\partial x_n} & \frac{\partial f_2}{\partial u_1} & \frac{\partial f_2}{\partial u_2} & \cdots & \frac{\partial f_2}{\partial u_m} \\ \vdots & \vdots & \ddots & \vdots & \vdots & \vdots & \ddots & \vdots \\ \frac{\partial f_m}{\partial x_1} & \frac{\partial f_m}{\partial x_2} & \cdots & \frac{\partial f_m}{\partial x_n} & \frac{\partial f_m}{\partial u_1} & \frac{\partial f_m}{\partial u_2} & \cdots & \frac{\partial f_m}{\partial u_m} \end{bmatrix} = \begin{bmatrix} \mathbf{I} & \mathbf{0} \\ \mathbf{F}_X & \mathbf{F}_U \end{bmatrix},$$

where  $\mathbf{I}$  is the  $n \times n$  identity matrix,  $\mathbf{0}$  is the  $n \times m$  matrix with all zero entries, and  $\mathbf{F}_X$  and  $\mathbf{F}_U$  are as in (6.4.5). By expanding  $\det(\Phi')$  and the determinants that evolve from it in terms of the cofactors of their first rows, it can be shown in  $n$  steps that

$$J\Phi = \det(\Phi') = \begin{vmatrix} \frac{\partial f_1}{\partial u_1} & \frac{\partial f_1}{\partial u_2} & \cdots & \frac{\partial f_1}{\partial u_m} \\ \frac{\partial f_2}{\partial u_1} & \frac{\partial f_2}{\partial u_2} & \cdots & \frac{\partial f_2}{\partial u_m} \\ \vdots & \vdots & \ddots & \vdots \\ \frac{\partial f_m}{\partial u_1} & \frac{\partial f_m}{\partial u_2} & \cdots & \frac{\partial f_m}{\partial u_m} \end{vmatrix} = \det(\mathbf{F}_U).$$

In particular,

$$J\Phi(\mathbf{X}_0, \mathbf{U}_0) = \det(\mathbf{F}_U(\mathbf{X}_0, \mathbf{U}_0)) \neq 0.$$

Since  $\Phi$  is continuously differentiable on  $S$ , Corollary 6.3.5 implies that  $\Phi$  is regular on some open neighborhood  $M$  of  $(\mathbf{X}_0, \mathbf{U}_0)$  and that  $\widehat{M} = \Phi(M)$  is open.

Because of the form of  $\Phi$  (see (6.4.8) or (6.4.9)), we can write points of  $\widehat{M}$  as  $(\mathbf{X}, \mathbf{V})$ , where  $\mathbf{V} \in \mathbb{R}^m$ . Corollary 6.3.5 also implies that  $\Phi$  has a continuously differentiable inverse  $\Gamma(\mathbf{X}, \mathbf{V})$  defined on  $\widehat{M}$  with values in  $M$ . Since  $\Phi$  leaves the “ $\mathbf{X}$  part” of  $(\mathbf{X}, \mathbf{U})$  fixed, a local inverse of  $\Phi$  must also have this property. Therefore,  $\Gamma$  must have the form

$$\Gamma(\mathbf{X}, \mathbf{V}) = \begin{bmatrix} x_1 \\ x_2 \\ \vdots \\ x_n \\ h_1(\mathbf{X}, \mathbf{V}) \\ h_2(\mathbf{X}, \mathbf{V}) \\ \vdots \\ h_m(\mathbf{X}, \mathbf{V}) \end{bmatrix}$$

or, in “horizontal” notation,

$$\Gamma(\mathbf{X}, \mathbf{V}) = (\mathbf{X}, \mathbf{H}(\mathbf{X}, \mathbf{V})),$$

where  $\mathbf{H} : \mathbb{R}^{n+m} \rightarrow \mathbb{R}^m$  is continuously differentiable on  $\widehat{M}$ . We will show that  $\mathbf{G}(\mathbf{X}) = \mathbf{H}(\mathbf{X}, \mathbf{0})$  has the stated properties.

From (6.4.10),  $(\mathbf{X}_0, \mathbf{0}) \in \widehat{M}$  and, since  $\widehat{M}$  is open, there is a neighborhood  $N$  of  $\mathbf{X}_0$  in  $\mathbb{R}^n$  such that  $(\mathbf{X}, \mathbf{0}) \in \widehat{M}$  if  $\mathbf{X} \in N$  (Exercise 6.4.2). Therefore,  $(\mathbf{X}, \mathbf{G}(\mathbf{X})) = \Gamma(\mathbf{X}, \mathbf{0}) \in M$  if  $\mathbf{X} \in N$ . Since  $\Gamma = \Phi^{-1}$ ,  $(\mathbf{X}, \mathbf{0}) = \Phi(\mathbf{X}, \mathbf{G}(\mathbf{X}))$ . Setting  $\mathbf{X} = \mathbf{X}_0$  and recalling (6.4.10) shows that  $\mathbf{G}(\mathbf{X}_0) = \mathbf{U}_0$ , since  $\Phi$  is one-to-one on  $M$ .

Henceforth we assume that  $\mathbf{X} \in N$ . Now,

$$\begin{aligned}(\mathbf{X}, \mathbf{0}) &= \Phi(\Gamma(\mathbf{X}, \mathbf{0})) && \text{(since } \Phi = \Gamma^{-1}\text{)} \\ &= \Phi(\mathbf{X}, \mathbf{G}(\mathbf{X})) && \text{(since } \Gamma(\mathbf{X}, \mathbf{0}) = (\mathbf{X}, \mathbf{G}(\mathbf{X}))\text{)} \\ &= (\mathbf{X}, \mathbf{F}(\mathbf{X}, \mathbf{G}(\mathbf{X}))) && \text{(since } \Phi(\mathbf{X}, \mathbf{U}) = (\mathbf{X}, \mathbf{F}(\mathbf{X}, \mathbf{U}))\text{)}.\end{aligned}$$

Therefore,  $\mathbf{F}(\mathbf{X}, \mathbf{G}(\mathbf{X})) = \mathbf{0}$ ; that is,  $\mathbf{G}$  satisfies (6.4.6). To see that  $\mathbf{G}$  is unique, suppose that  $\mathbf{G}_1 : \mathbb{R}^n \rightarrow \mathbb{R}^m$  also satisfies (6.4.6). Then

$$\Phi(\mathbf{X}, \mathbf{G}(\mathbf{X})) = (\mathbf{X}, \mathbf{F}(\mathbf{X}, \mathbf{G}(\mathbf{X}))) = (\mathbf{X}, \mathbf{0})$$

and

$$\Phi(\mathbf{X}, \mathbf{G}_1(\mathbf{X})) = (\mathbf{X}, \mathbf{F}(\mathbf{X}, \mathbf{G}_1(\mathbf{X}))) = (\mathbf{X}, \mathbf{0})$$

for all  $\mathbf{X}$  in  $N$ . Since  $\Phi$  is one-to-one on  $M$ , this implies that  $\mathbf{G}(\mathbf{X}) = \mathbf{G}_1(\mathbf{X})$ .

Since the partial derivatives

$$\frac{\partial h_i}{\partial x_j}, \quad 1 \leq i \leq m, \quad 1 \leq j \leq n,$$

are continuous functions of  $(\mathbf{X}, \mathbf{V})$  on  $\widehat{M}$ , they are continuous with respect to  $\mathbf{X}$  on the subset  $\{(\mathbf{X}, \mathbf{0}) \mid \mathbf{X} \in N\}$  of  $\widehat{M}$ . Therefore,  $\mathbf{G}$  is continuously differentiable on  $N$ . To verify (6.4.7), we write  $\mathbf{F}(\mathbf{X}, \mathbf{G}(\mathbf{X})) = \mathbf{0}$  in terms of components; thus,

$$f_i(x_1, x_2, \dots, x_n, g_1(\mathbf{X}), g_2(\mathbf{X}), \dots, g_m(\mathbf{X})) = 0, \quad 1 \leq i \leq m, \quad \mathbf{X} \in N.$$

Since  $f_i$  and  $g_1, g_2, \dots, g_m$  are continuously differentiable on their respective domains, the chain rule (Theorem 5.4.3) implies that

$$\frac{\partial f_i(\mathbf{X}, \mathbf{G}(\mathbf{X}))}{\partial x_j} + \sum_{r=1}^m \frac{\partial f_i(\mathbf{X}, \mathbf{G}(\mathbf{X}))}{\partial u_r} \frac{\partial g_r(\mathbf{X})}{\partial x_j} = 0, \quad 1 \leq i \leq m, \quad 1 \leq j \leq n, \quad (6.4.11)$$

or, in matrix form,

$$\mathbf{F}_X(\mathbf{X}, \mathbf{G}(\mathbf{X})) + \mathbf{F}_U(\mathbf{X}, \mathbf{G}(\mathbf{X}))\mathbf{G}'(\mathbf{X}) = \mathbf{0}. \quad (6.4.12)$$

Since  $(\mathbf{X}, \mathbf{G}(\mathbf{X})) \in M$  for all  $\mathbf{X}$  in  $N$  and  $\mathbf{F}_U(\mathbf{X}, \mathbf{U})$  is nonsingular when  $(\mathbf{X}, \mathbf{U}) \in M$ , we can multiply (6.4.12) on the left by  $\mathbf{F}_U^{-1}(\mathbf{X}, \mathbf{G}(\mathbf{X}))$  to obtain (6.4.7). This completes the proof. ■

In Theorem 6.4.1 we denoted the implicitly defined transformation by  $\mathbf{G}$  for reasons of clarity in the proof. However, in applying the theorem it is convenient to denote the transformation more informally by  $\mathbf{U} = \mathbf{U}(\mathbf{X})$ ; thus,  $\mathbf{U}(\mathbf{X}_0) = \mathbf{U}_0$ , and we replace (6.4.6) and (6.4.7) by

$$(\mathbf{X}, \mathbf{U}(\mathbf{X})) \in M \quad \text{and} \quad \mathbf{X}(\mathbf{X}, \mathbf{U}(\mathbf{X})) = 0 \quad \text{if} \quad \mathbf{X} \in N,$$

and

$$\mathbf{U}'(\mathbf{X}) = -[\mathbf{F}_U(\mathbf{X}, \mathbf{U}(\mathbf{X}))]^{-1}\mathbf{F}_X(\mathbf{X}, \mathbf{U}(\mathbf{X})), \quad \mathbf{X} \in N,$$

while (6.4.11) becomes

$$\frac{\partial f_i}{\partial x_j} + \sum_{r=1}^m \frac{\partial f_i}{\partial u_r} \frac{\partial u_r}{\partial x_j} = 0, \quad 1 \leq i \leq m, \quad 1 \leq j \leq n, \quad (6.4.13)$$

it being understood that the partial derivatives of  $u_r$  and  $f_i$  are evaluated at  $\mathbf{X}$  and  $(\mathbf{X}, \mathbf{U}(\mathbf{X}))$ , respectively.

The following corollary is the implicit function theorem for  $m = 1$ .

**Corollary 6.4.2** *Suppose that  $f : \mathbb{R}^{n+1} \rightarrow \mathbb{R}$  is continuously differentiable on an open set containing  $(\mathbf{X}_0, u_0)$ , with  $f(\mathbf{X}_0, u_0) = 0$  and  $f_u(\mathbf{X}_0, u_0) \neq 0$ . Then there is a neighborhood  $M$  of  $(\mathbf{X}_0, u_0)$ , contained in  $S$ , and a neighborhood  $N$  of  $\mathbf{X}_0$  in  $\mathbb{R}^n$  on which is defined a unique continuously differentiable function  $u = u(\mathbf{X}) : \mathbb{R}^n \rightarrow \mathbb{R}$  such that*

$$\begin{aligned} (\mathbf{X}, u(\mathbf{X})) \in M \quad \text{and} \quad f_u(\mathbf{X}, u(\mathbf{X})) \neq 0, \quad \mathbf{X} \in N, \\ u(\mathbf{X}_0) = u_0, \quad \text{and} \quad f(\mathbf{X}, u(\mathbf{X})) = 0, \quad \mathbf{X} \in N. \end{aligned}$$

The partial derivatives of  $u$  are given by

$$u_{x_i}(\mathbf{X}) = -\frac{f_{x_i}(\mathbf{X}, u(\mathbf{X}))}{f_u(\mathbf{X}, u(\mathbf{X}))}, \quad 1 \leq i \leq n.$$

**Example 6.4.1** Let

$$f(x, y, u) = 1 - x^2 - y^2 - u^2$$

and  $(x_0, y_0, u_0) = (\frac{1}{2}, -\frac{1}{2}, \frac{1}{\sqrt{2}})$ . Then  $f(x_0, y_0, u_0) = 0$  and

$$f_x(x, y, u) = -2x, \quad f_y(x, y, u) = -2y, \quad f_u(x, y, u) = -2u.$$

Since  $f$  is continuously differentiable everywhere and  $f_u(x_0, y_0, u_0) = -\sqrt{2} \neq 0$ , Corollary 6.4.2 implies that the conditions

$$1 - x^2 - y^2 - u^2 = 0, \quad u(1/2, -1/2) = \frac{1}{\sqrt{2}},$$

determine  $u = u(x, y)$  near  $(x_0, y_0) = (\frac{1}{2}, -\frac{1}{2})$  so that

$$u_x(x, y) = -\frac{f_x(x, y, u(x, y))}{f_u(x, y, u(x, y))} = \frac{-x}{u(x, y)}, \quad (6.4.14)$$

and

$$u_y(x, y) = -\frac{f_y(x, y, u(x, y))}{f_u(x, y, u(x, y))} = \frac{-y}{u(x, y)}. \quad (6.4.15)$$

■

It is not necessary to memorize formulas like (6.4.14) and (6.4.15). Since we know that  $f$  and  $u$  are differentiable, we can obtain (6.4.14) and (6.4.15) by applying the chain rule to the identity

$$f(x, y, u(x, y)) = 0.$$



**Example 6.4.2** Let

$$f(x, y, u) = x^3y^2u^2 + 3xy^4u^4 - 3x^6y^6u^7 + 12x - 13 \quad (6.4.16)$$

and  $(x_0, y_0, u_0) = (1, -1, 1)$ , so  $f(x_0, y_0, u_0) = 0$ . Then

$$f_x(x, y, u) = 3x^2y^2u^2 + 3y^4u^4 - 18x^5y^6u^7 + 12,$$

$$f_y(x, y, u) = 2x^3yu^2 + 12xy^3u^4 - 18x^6y^5u^7,$$

$$f_u(x, y, u) = 2x^3y^2u + 12xy^4u^3 - 21x^6y^6u^6.$$

Since  $f_u(1, -1, 1) = -7 \neq 0$ , Corollary 6.4.2 implies that the conditions

$$f(x, y, u) = 0, \quad u(1, -1) = 1 \quad (6.4.17)$$

determine  $u$  as a continuously differentiable function of  $(x, y)$  near  $(1, -1)$ . ■

If we try to solve (6.4.16) for  $u$ , we see very clearly that Theorem 6.4.1 and Corollary 6.4.2 are *existence* theorems; that is, they tell us that there is a function  $u = u(x, y)$  that satisfies (6.4.17), but not how to find it. In this case there is no convenient formula for the function, although its partial derivatives can be expressed conveniently in terms of  $x$ ,  $y$ , and  $u(x, y)$ :

$$u_x(x, y) = -\frac{f_x(x, y, u(x, y))}{f_u(x, y, u(x, y))}, \quad u_y(x, y) = -\frac{f_y(x, y, u(x, y))}{f_u(x, y, u(x, y))}.$$

In particular, since  $u(1, -1) = 1$ ,

$$u_x(1, -1) = -\frac{0}{-7} = 0, \quad u_y(1, -1) = -\frac{4}{-7} = \frac{4}{7}.$$

**Example 6.4.3** Let

$$\mathbf{X} = \begin{bmatrix} x \\ y \\ z \end{bmatrix} \quad \text{and} \quad \mathbf{U} = \begin{bmatrix} u \\ v \end{bmatrix},$$

and

$$\mathbf{F}(\mathbf{X}, \mathbf{U}) = \begin{bmatrix} 2x^2 + y^2 + z^2 + u^2 - v^2 \\ x^2 + z^2 + 2u - v \end{bmatrix}.$$

If  $\mathbf{X}_0 = (1, -1, 1)$  and  $\mathbf{U}_0 = (0, 2)$ , then  $\mathbf{F}(\mathbf{X}_0, \mathbf{U}_0) = \mathbf{0}$ . Moreover,

$$\mathbf{F}_U(\mathbf{X}, \mathbf{U}) = \begin{bmatrix} 2u & -2v \\ 2 & -1 \end{bmatrix} \quad \text{and} \quad \mathbf{F}_X = \begin{bmatrix} 4x & 2y & 2z \\ 2x & 0 & 2z \end{bmatrix},$$

so

$$\det(\mathbf{F}_U(\mathbf{X}_0, \mathbf{U}_0)) = \begin{vmatrix} 0 & -4 \\ 2 & -1 \end{vmatrix} = 8 \neq 0.$$

Hence, the conditions

$$\mathbf{F}(\mathbf{X}, \mathbf{U}) = \mathbf{0}, \quad \mathbf{U}(1, -1, 1) = (0, 2)$$

determine  $\mathbf{U} = \mathbf{U}(\mathbf{X})$  near  $\mathbf{X}_0$ . Although it is difficult to find  $\mathbf{U}(\mathbf{X})$  explicitly, we can approximate  $\mathbf{U}(\mathbf{X})$  near  $\mathbf{X}_0$  by an affine transformation. Thus, from (6.4.7),

$$\begin{aligned} \mathbf{U}'(\mathbf{X}_0) &= -[\mathbf{F}_U(\mathbf{X}_0, \mathbf{U}(\mathbf{X}_0))]^{-1} \mathbf{F}_X(\mathbf{X}_0, \mathbf{U}(\mathbf{X}_0)) & (6.4.18) \\ &= - \begin{bmatrix} 0 & -4 \\ 2 & -1 \end{bmatrix}^{-1} \begin{bmatrix} 4 & -2 & 2 \\ 2 & 0 & 2 \end{bmatrix} \\ &= -\frac{1}{8} \begin{bmatrix} -1 & 4 \\ -2 & 0 \end{bmatrix} \begin{bmatrix} 4 & -2 & 2 \\ 2 & 0 & 2 \end{bmatrix} \\ &= -\frac{1}{8} \begin{bmatrix} 4 & 2 & 6 \\ -8 & 4 & -4 \end{bmatrix}. \end{aligned}$$

Therefore,

$$\lim_{\mathbf{x} \rightarrow (1, -1, 1)} \frac{\begin{bmatrix} u(x, y) \\ v(x, y) \end{bmatrix} - \begin{bmatrix} 0 \\ 2 \end{bmatrix} + \frac{1}{8} \begin{bmatrix} 4 & 2 & 6 \\ -8 & 4 & -4 \end{bmatrix} \begin{bmatrix} x-1 \\ y+1 \\ z-1 \end{bmatrix}}{[(x-1)^2 + (y+1)^2 + (z-1)^2]^{1/2}} = \begin{bmatrix} 0 \\ 0 \end{bmatrix}. \quad \blacksquare$$

Again, it is not necessary to memorize (6.4.18), since the partial derivatives of an implicitly defined function can be obtained from the chain rule and Cramer's rule, as in the next example.

**Example 6.4.4** Let  $u = u(x, y)$  and  $v = v(x, y)$  be differentiable and satisfy

$$\begin{aligned} x^2 + 2y^2 + 3z^2 + u^2 + v &= 6 \\ 2x^3 + 4y^2 + 2z^2 + u + v^2 &= 9 \end{aligned} \quad (6.4.19)$$

and

$$u(1, -1, 0) = -1, \quad v(1, -1, 0) = 2. \quad (6.4.20)$$

To find  $u_x$  and  $v_x$ , we differentiate (6.4.19) with respect to  $x$  to obtain

$$\begin{aligned} 2x + 2uu_x + v_x &= 0 \\ 6x^2 + u_x + 2vv_x &= 0. \end{aligned}$$

Therefore,

$$\begin{bmatrix} 2u & 1 \\ 1 & 2v \end{bmatrix} \begin{bmatrix} u_x \\ v_x \end{bmatrix} = - \begin{bmatrix} 2x \\ 6x^2 \end{bmatrix},$$

and Cramer's rule yields

$$u_x = -\frac{\begin{vmatrix} 2x & 1 \\ 6x^2 & 2v \end{vmatrix}}{\begin{vmatrix} 2u & 1 \\ 1 & 2v \end{vmatrix}} = \frac{6x^2 - 4xv}{4uv - 1}$$

and

$$v_x = -\frac{\begin{vmatrix} 2u & 2x \\ 1 & 6x^2 \end{vmatrix}}{\begin{vmatrix} 2u & 1 \\ 1 & 2v \end{vmatrix}} = \frac{2x - 12x^2u}{4uv - 1}$$

if  $4uv \neq 1$ . In particular, from (6.4.20),

$$u_x(1, -1, 0) = \frac{-2}{-9} = \frac{2}{9}, \quad v_x(1, -1, 0) = \frac{14}{-9} = -\frac{14}{9}.$$

## Jacobians

It is convenient to extend the notation introduced in Section 6.2 for the Jacobian of a transformation  $\mathbf{F} : \mathbb{R}^m \rightarrow \mathbb{R}^m$ . If  $f_1, f_2, \dots, f_m$  are real-valued functions of  $k$  variables,  $k \geq m$ , and  $\xi_1, \xi_2, \dots, \xi_m$  are any  $m$  of the variables, then we call the determinant

$$\begin{vmatrix} \frac{\partial f_1}{\partial \xi_1} & \frac{\partial f_1}{\partial \xi_2} & \cdots & \frac{\partial f_1}{\partial \xi_m} \\ \frac{\partial f_2}{\partial \xi_1} & \frac{\partial f_2}{\partial \xi_2} & \cdots & \frac{\partial f_2}{\partial \xi_m} \\ \vdots & \vdots & \ddots & \vdots \\ \frac{\partial f_m}{\partial \xi_1} & \frac{\partial f_m}{\partial \xi_2} & \cdots & \frac{\partial f_m}{\partial \xi_m} \end{vmatrix},$$

the *Jacobian of  $f_1, f_2, \dots, f_m$  with respect to  $\xi_1, \xi_2, \dots, \xi_m$* . We denote this Jacobian by

$$\frac{\partial(f_1, f_2, \dots, f_m)}{\partial(\xi_1, \xi_2, \dots, \xi_m)},$$

and we denote the value of the Jacobian at a point  $\mathbf{P}$  by

$$\left. \frac{\partial(f_1, f_2, \dots, f_m)}{\partial(\xi_1, \xi_2, \dots, \xi_m)} \right|_{\mathbf{P}}.$$

**Example 6.4.5** If

$$\mathbf{F}(x, y, z) = \begin{bmatrix} 3x^2 + 2xy + z^2 \\ 4x^2 + 2xy^2 + z^3 \end{bmatrix},$$

then

$$\frac{\partial(f_1, f_2)}{\partial(x, y)} = \begin{vmatrix} 6x + 2y & 2x \\ 8x + 2y^2 & 4xy \end{vmatrix}, \quad \frac{\partial(f_1, f_2)}{\partial(y, z)} = \begin{vmatrix} 2x & 2z \\ 4xy & 3z^2 \end{vmatrix},$$

and

$$\frac{\partial(f_1, f_2)}{\partial(z, x)} = \begin{vmatrix} 2z & 6x + 2y \\ 3z^2 & 8x + 2y^2 \end{vmatrix}.$$

The values of these Jacobians at  $\mathbf{X}_0 = (-1, 1, 0)$  are

$$\frac{\partial(f_1, f_2)}{\partial(x, y)} \Big|_{\mathbf{X}_0} = \begin{vmatrix} -4 & -2 \\ -6 & -4 \end{vmatrix} = 4, \quad \frac{\partial(f_1, f_2)}{\partial(y, z)} \Big|_{\mathbf{X}_0} = \begin{vmatrix} -2 & 0 \\ -4 & 0 \end{vmatrix} = 0,$$

and

$$\frac{\partial(f_1, f_2)}{\partial(z, x)} \Big|_{\mathbf{X}_0} = \begin{vmatrix} 0 & -4 \\ 0 & -6 \end{vmatrix} = 0. \quad \blacksquare$$

The requirement in Theorem 6.4.1 that  $\mathbf{F}_U(\mathbf{X}_0, \mathbf{U}_0)$  be nonsingular is equivalent to

$$\frac{\partial(f_1, f_2, \dots, f_m)}{\partial(u_1, u_2, \dots, u_m)} \Big|_{(\mathbf{X}_0, \mathbf{U}_0)} \neq 0.$$

If this is so then, for a fixed  $j$ , Cramer's rule allows us to write the solution of (6.4.13) as

$$\frac{\partial u_i}{\partial x_j} = - \frac{\frac{\partial(f_1, f_2, \dots, f_i, \dots, f_m)}{\partial(u_1, u_2, \dots, x_j, \dots, u_m)}}{\frac{\partial(f_1, f_2, \dots, f_i, \dots, f_m)}{\partial(u_1, u_2, \dots, u_i, \dots, u_m)}}, \quad 1 \leq i \leq m,$$

Notice that the determinant in the numerator on the right is obtained by replacing the  $i$ th column of the determinant in the denominator, which is

$$\begin{bmatrix} \frac{\partial f_1}{\partial u_i} \\ \frac{\partial f_2}{\partial u_i} \\ \vdots \\ \frac{\partial f_m}{\partial u_i} \end{bmatrix}, \quad \text{by} \quad \begin{bmatrix} \frac{\partial f_1}{\partial x_j} \\ \frac{\partial f_2}{\partial x_j} \\ \vdots \\ \frac{\partial f_m}{\partial x_j} \end{bmatrix}.$$

So far we have considered only the problem of solving a continuously differentiable system

$$\mathbf{F}(\mathbf{X}, \mathbf{U}) = \mathbf{0} \quad (\mathbf{F} : \mathbb{R}^{n+m} \rightarrow \mathbb{R}^m) \tag{6.4.21}$$

for the last  $m$  variables,  $u_1, u_2, \dots, u_m$ , in terms of the first  $n$ ,  $x_1, x_2, \dots, x_n$ . This was merely for convenience; (6.4.21) can be solved near  $(\mathbf{X}_0, \mathbf{U}_0)$  for any  $m$  of the variables in terms of the other  $n$ , provided only that the Jacobian of  $f_1, f_2, \dots, f_m$  with respect to the chosen  $m$  variables is nonzero at  $(\mathbf{X}_0, \mathbf{U}_0)$ . This can be seen by renaming the variables and applying Theorem 6.4.1.

**Example 6.4.6** Let

$$\mathbf{F}(x, y, z) = \begin{bmatrix} f(x, y, z) \\ g(x, y, z) \end{bmatrix}$$

be continuously differentiable in a neighborhood of  $(x_0, y_0, z_0)$ . Suppose that

$$\mathbf{F}(x_0, y_0, z_0) = \mathbf{0}$$

and

$$\left. \frac{\partial(f, g)}{\partial(x, z)} \right|_{(x_0, y_0, z_0)} \neq 0. \quad (6.4.22)$$

Then Theorem 6.4.1 with  $\mathbf{X} = (y)$  and  $\mathbf{U} = (x, z)$  implies that the conditions

$$f(x, y, z) = 0, \quad g(x, y, z) = 0, \quad x(y_0) = x_0, \quad z(y_0) = z_0, \quad (6.4.23)$$

determine  $x$  and  $z$  as continuously differentiable functions of  $y$  near  $y_0$ . Differentiating (6.4.23) with respect to  $y$  and regarding  $x$  and  $z$  as functions of  $y$  yields

$$\begin{aligned} f_x x' + f_y + f_z z' &= 0 \\ g_x x' + g_y + g_z z' &= 0. \end{aligned}$$

Rewriting this as

$$\begin{aligned} f_x x' + f_z z' &= -f_y \\ g_x x' + g_z z' &= -g_y, \end{aligned}$$

and solving for  $x'$  and  $z'$  by Cramer's rule yields

$$x' = \frac{\begin{vmatrix} -f_y & f_z \\ -g_y & g_z \end{vmatrix}}{\begin{vmatrix} f_x & f_z \\ g_x & g_z \end{vmatrix}} = -\frac{\frac{\partial(f, g)}{\partial(y, z)}}{\frac{\partial(f, g)}{\partial(x, z)}} \quad (6.4.24)$$

and

$$z' = \frac{\begin{vmatrix} f_x & -f_y \\ g_x & -g_y \end{vmatrix}}{\begin{vmatrix} f_x & f_z \\ g_x & g_z \end{vmatrix}} = -\frac{\frac{\partial(f, g)}{\partial(x, y)}}{\frac{\partial(f, g)}{\partial(x, z)}}. \quad (6.4.25)$$

Equation (6.4.22) implies that  $\partial(f, g)/\partial(x, z)$  is nonzero if  $y$  is sufficiently close to  $y_0$ .

**Example 6.4.7** Let  $\mathbf{X}_0 = (1, 1, 2)$  and

$$\mathbf{F}(x, y, z) = \begin{bmatrix} f(x, y, z) \\ g(x, y, z) \end{bmatrix} = \begin{bmatrix} 6x + 6y + 4z^3 - 44 \\ -x^2 - y^2 + 8z - 14 \end{bmatrix}.$$

Then  $\mathbf{F}(\mathbf{X}_0) = \mathbf{0}$ ,

$$\frac{\partial(f, g)}{\partial(x, z)} = \begin{vmatrix} 6 & 12z^2 \\ -2x & 8 \end{vmatrix},$$

and

$$\left. \frac{\partial(f, g)}{\partial(x, z)} \right|_{(1,1,2)} = \begin{vmatrix} 6 & 48 \\ -2 & 8 \end{vmatrix} = 144 \neq 0.$$

Therefore, Theorem 6.4.1 with  $\mathbf{X} = (y)$  and  $\mathbf{U} = (x, z)$  implies that the conditions

$$f(x, y, z) = 0, \quad g(x, y, z) = 0,$$

and

$$x(1) = 1, \quad z(1) = 2, \tag{6.4.26}$$

determine  $x$  and  $z$  as continuously differentiable functions of  $y$  near  $y_0 = 1$ . From (6.4.24) and (6.4.25),

$$x' = -\frac{\frac{\partial(f, g)}{\partial(y, z)}}{\frac{\partial(f, g)}{\partial(x, z)}} = -\frac{\begin{vmatrix} 6 & 12z^2 \\ -2y & 8 \end{vmatrix}}{\begin{vmatrix} 6 & 12z^2 \\ -2x & 8 \end{vmatrix}} = -\frac{2 + yz^2}{2 + xz^2}$$

and

$$z' = -\frac{\frac{\partial(f, g)}{\partial(x, y)}}{\frac{\partial(f, g)}{\partial(x, z)}} = -\frac{\begin{vmatrix} 6 & 6 \\ -2x & -2y \end{vmatrix}}{\begin{vmatrix} 6 & 12z^2 \\ -2x & 8 \end{vmatrix}} = \frac{y - x}{4 + 2xz^2}.$$

These equations hold near  $y = 1$ . Together with (6.4.26) they imply that

$$x'(1) = -1, \quad z'(1) = 0.$$

**Example 6.4.8** Continuing with Example 6.4.7, Theorem 6.4.1 implies that the conditions

$$f(x, y, z) = 0, \quad g(x, y, z) = 0, \quad y(1) = 1, \quad z(1) = 2$$

determine  $y$  and  $z$  as functions of  $x$  near  $x_0 = 1$ , since

$$\frac{\partial(f, g)}{\partial(y, z)} = \begin{vmatrix} 6 & 12z^2 \\ -2y & 8 \end{vmatrix}$$

and

$$\left. \frac{\partial(f, g)}{\partial(y, z)} \right|_{(1,1,2)} = \begin{vmatrix} 6 & 48 \\ -2 & 8 \end{vmatrix} = 144 \neq 0.$$

However, Theorem 6.4.1 does not imply that the conditions

$$f(x, y, z) = 0, \quad g(x, y, z) = 0, \quad x(2) = 1, \quad y(2) = 1$$

define  $x$  and  $y$  as functions of  $z$  near  $z_0 = 2$ , since

$$\frac{\partial(f, g)}{\partial(x, y)} = \begin{vmatrix} 6 & 6 \\ -2x & -2y \end{vmatrix}$$

and

$$\frac{\partial(f, g)}{\partial(x, y)} \Big|_{(1,1,2)} = \begin{vmatrix} 6 & 6 \\ -2 & -2 \end{vmatrix} = 0. \quad \blacksquare$$

We close this section by observing that the functions  $u_1, u_2, \dots, u_m$  defined in Theorem 6.4.1 have higher derivatives if  $f_1, f_2, \dots, f_m$  do, and they may be obtained by differentiating (6.4.13), using the chain rule. (Exercise 6.4.17).

**Example 6.4.9** Suppose that  $u$  and  $v$  are functions of  $(x, y)$  that satisfy

$$f(x, y, u, v) = x - u^2 - v^2 + 9 = 0$$

$$g(x, y, u, v) = y - u^2 + v^2 - 10 = 0.$$

Then

$$\frac{\partial(f, g)}{\partial(u, v)} = \begin{vmatrix} -2u & -2v \\ -2u & 2v \end{vmatrix} = -8uv.$$

From Theorem 6.4.1, if  $uv \neq 0$ , then

$$u_x = \frac{1}{8uv} \frac{\partial(f, g)}{\partial(x, v)} = \frac{1}{8uv} \begin{vmatrix} 1 & -2v \\ 0 & 2v \end{vmatrix} = \frac{1}{4u},$$

$$u_y = \frac{1}{8uv} \frac{\partial(f, g)}{\partial(y, v)} = \frac{1}{8uv} \begin{vmatrix} 0 & -2v \\ 1 & 2v \end{vmatrix} = \frac{1}{4u},$$

$$v_x = \frac{1}{8uv} \frac{\partial(f, g)}{\partial(u, x)} = \frac{1}{8uv} \begin{vmatrix} -2u & 1 \\ -2u & 0 \end{vmatrix} = \frac{1}{4v},$$

$$v_y = \frac{1}{8uv} \frac{\partial(f, g)}{\partial(u, y)} = \frac{1}{8uv} \begin{vmatrix} -2u & 0 \\ -2u & 1 \end{vmatrix} = -\frac{1}{4v}.$$

These can be differentiated as many times as we wish. For example,

$$u_{xx} = -\frac{u_x}{4u^2} = -\frac{1}{16u^3},$$

$$u_{xy} = -\frac{u_y}{4u^2} = -\frac{1}{16u^3},$$

and

$$v_{yx} = \frac{v_x}{4v^2} = \frac{1}{16v^2}.$$

## 6.4 Exercises

1. Solve for  $\mathbf{U} = (u, \dots)$  as a function of  $\mathbf{X} = (x, \dots)$ .

$$(a) \begin{bmatrix} 1 & 1 \\ 1 & -1 \end{bmatrix} \begin{bmatrix} u \\ v \end{bmatrix} + \begin{bmatrix} 1 & -1 \\ 2 & -3 \end{bmatrix} \begin{bmatrix} x \\ y \end{bmatrix} = \begin{bmatrix} 0 \\ 0 \end{bmatrix}$$

$$(b) \begin{aligned} u - v + w + 3x + 2y &= 0 \\ -u + v + w - x + y &= 0 \\ u + v - w + y &= 0 \end{aligned}$$

$$(c) \begin{aligned} 3u + v + y &= \sin x \\ u + 2v + x &= \sin y \end{aligned}$$

$$(d) \begin{aligned} 2u + 2v + w + 2x + 2y + z &= 0 \\ u - v + 2w + x - y + 2z &= 0 \\ 3u + 2v - w + 3x + 2y - z &= 0 \end{aligned}$$

2. Suppose that  $\mathbf{X}_0 \in \mathbb{R}^n$  and  $\mathbf{U}_0 \in \mathbb{R}^m$ . Prove: If  $N_1$  is a neighborhood of  $(\mathbf{X}_0, \mathbf{U}_0)$  in  $\mathbb{R}^{n+m}$ , there is a neighborhood  $N$  of  $\mathbf{X}_0$  in  $\mathbb{R}^n$  such that  $(\mathbf{X}, \mathbf{U}_0) \in N_1$  if  $\mathbf{X} \in N$ .
3. Let  $(\mathbf{X}_0, \mathbf{U}_0)$  be an arbitrary point in  $\mathbb{R}^{n+m}$ . Give an example of a function  $\mathbf{F} : \mathbb{R}^{n+m} \rightarrow \mathbb{R}^m$  such that  $\mathbf{F}$  is continuously differentiable on  $\mathbb{R}^{n+m}$ ,  $\mathbf{F}(\mathbf{X}_0, \mathbf{U}_0) = \mathbf{0}$ ,  $\mathbf{F}_{\mathbf{U}}(\mathbf{X}_0, \mathbf{U}_0)$  is singular, and the conditions  $\mathbf{F}(\mathbf{X}, \mathbf{U}) = \mathbf{0}$  and  $\mathbf{U}(\mathbf{X}_0) = \mathbf{Y}_0$
- (a) determine  $\mathbf{U}$  as a continuously differentiable function of  $\mathbf{X}$  for all  $\mathbf{X}$ ;
- (b) determine  $\mathbf{U}$  as a continuous function of  $\mathbf{X}$  for all  $\mathbf{X}$ , but  $\mathbf{U}$  is not differentiable at  $\mathbf{X}_0$ ;
- (c) do not determine  $\mathbf{U}$  as a function of  $\mathbf{X}$ .
4. Let  $u = u(x, y)$  be determined near  $(1, 1)$  by

$$x^2 y u + 2x y^2 u^3 - 3x^3 y^3 u^5 = 0, \quad u(1, 1) = 1.$$

Find  $u_x(1, 1)$  and  $u_y(1, 1)$ .

5. Let  $u = u(x, y, z)$  be determined near  $(1, 1, 1)$  by

$$x^2 y^5 z^2 u^5 + 2x y^2 u^3 - 3x^3 z^2 u = 0, \quad u(1, 1, 1) = 1.$$

Find  $u_x(1, 1, 1)$ ,  $u_y(1, 1, 1)$ , and  $u_z(1, 1, 1)$ .

6. Find  $u(x_0, y_0)$ ,  $u_x(x_0, y_0)$ , and  $u_y(x_0, y_0)$ .

$$(a) 2x^2 + y^2 + ue^u = 6, \quad (x_0, y_0) = (1, 2)$$

$$(b) u(x+1) + x(y+2) + y(u-2) = 0, \quad (x_0, y_0) = (-1, -2)$$

$$(c) 1 - e^u \sin(x+y) = 0, \quad (x_0, y_0) = (\pi/4, \pi/4)$$

$$(d) x \log u + y \log x + u \log y = 0, \quad (x_0, y_0) = (1, 1)$$



7. Find  $u(x_0, y_0)$ ,  $u_x(x_0, y_0)$ , and  $u_y(x_0, y_0)$  for all continuously differentiable functions  $u$  that satisfy the given equation near  $(x_0, y_0)$ .

(a)  $2x^2y^4 - 3uxy^3 + u^2x^4y^3 = 0$ ;  $(x_0, y_0) = (1, 1)$

(b)  $\cos u \cos x + \sin u \sin y = 0$ ;  $(x_0, y_0) = (0, \pi)$

8. Suppose that  $\mathbf{U} = (u, v)$  is continuously differentiable with respect to  $(x, y, z)$  and satisfies

$$x^2 + 4y^2 + z^2 - 2u^2 + v^2 = -4$$

$$(x + z)^2 + u - v = -3$$

and

$$u(1, \frac{1}{2}, -1) = -2, \quad v(1, \frac{1}{2}, -1) = 1.$$

Find  $\mathbf{U}'(1, \frac{1}{2}, -1)$ .

9. Let  $u$  and  $v$  be continuously differentiable with respect to  $x$  and satisfy

$$u + 2u^2 + v^2 + x^2 + 2v - x = 0$$

$$xuv + e^u \sin(v + x) = 0$$

and  $u(0) = v(0) = 0$ . Find  $u'(0)$  and  $v'(0)$ .

10. Let  $\mathbf{U} = (u, v, w)$  be continuously differentiable with respect to  $(x, y)$  and satisfy

$$x^2y + xy^2 + u^2 - (v + w)^2 = -3$$

$$e^{x+y} - u - v - w = -2$$

$$(x + y)^2 + u + v + w^2 = 3$$

and  $\mathbf{U}(1, -1) = (1, 2, 0)$ . Find  $\mathbf{U}'(1, -1)$ .

11. Two continuously differentiable transformations  $\mathbf{U} = (u, v)$  of  $(x, y)$  satisfy the system

$$xyu - 4yu + 9xv = 0$$

$$2xy - 3y^2 + v^2 = 0$$

near  $(x_0, y_0) = (1, 1)$ . Find the value of each transformation and its differential matrix at  $(1, 1)$ .

12. Suppose that  $u$ ,  $v$ , and  $w$  are continuously differentiable functions of  $(x, y, z)$  that satisfy the system

$$e^x \cos y + e^z \cos u + e^v \cos w + x = 3$$

$$e^x \sin y + e^z \sin u + e^v \cos w = 1$$

$$e^x \tan y + e^z \tan u + e^v \tan w + z = 0$$

near  $(x_0, y_0, z_0) = (0, 0, 0)$ , and  $u(0, 0, 0) = v(0, 0, 0) = w(0, 0, 0) = 0$ . Find  $u_x(0, 0, 0)$ ,  $v_x(0, 0, 0)$ , and  $w_x(0, 0, 0)$ .

13. Let  $\mathbf{F} = (f, g, h)$  be continuously differentiable in a neighborhood of  $\mathbf{P}_0 = (x_0, y_0, z_0, u_0, v_0)$ ,  $\mathbf{F}(\mathbf{P}_0) = \mathbf{0}$ , and

$$\left. \frac{\partial(f, g, h)}{\partial(y, z, u)} \right|_{\mathbf{P}_0} \neq 0.$$

Then Theorem 6.4.1 implies that the conditions

$$\mathbf{F}(x, y, z, u, v) = \mathbf{0}, \quad y(x_0, v_0) = u_0, \quad z(x_0, v_0) = z_0, \quad u(x_0, v_0) = u_0$$

determine  $y$ ,  $z$ , and  $u$  as continuously differentiable functions of  $(x, v)$  near  $(x_0, v_0)$ . Use Cramer's rule to express their first partial derivatives as ratios of Jacobians.

14. Decide which pairs of the variables  $x$ ,  $y$ ,  $z$ ,  $u$ , and  $v$  are determined as functions of the others by the system

$$\begin{aligned} x + 2y + 3z + u + 6v &= 0 \\ 2x + 4y + z + 2u + 2v &= 0, \end{aligned}$$

and solve for them.

15. Let  $y$  and  $v$  be continuously differentiable functions of  $(x, z, u)$  that satisfy

$$\begin{aligned} x^2 + 4y^2 + z^2 - 2u^2 + v^2 &= -4 \\ (x + z)^2 + u - v &= -3 \end{aligned}$$

near  $(x_0, z_0, u_0) = (1, -1, -2)$ , and suppose that

$$y(1, -1, -2) = \frac{1}{2}, \quad v(1, -1, -2) = 1.$$

Find  $y_x(1, -1, -2)$  and  $v_u(1, -1, -2)$ .

16. Let  $u$ ,  $v$ , and  $x$  be continuously differentiable functions of  $(w, y)$  that satisfy

$$\begin{aligned} x^2y + xy^2 + u^2 - (v + w)^2 &= -3 \\ e^{x+y} - u - v - w &= -2 \\ (x + y)^2 + u + v + w^2 &= 3 \end{aligned}$$

near  $(w_0, y_0) = (0, -1)$ , and suppose that

$$u(0, -1) = 1, \quad v(0, -1) = 2, \quad x(0, -1) = 1.$$

Find the first partial derivatives of  $u$ ,  $v$ , and  $x$  with respect to  $y$  and  $w$  at  $(0, -1)$ .

17. In addition to the assumptions of Theorem 6.4.1, suppose that  $\mathbf{F}$  has all partial derivatives of order  $\leq q$  in  $S$ . Show that  $\mathbf{U} = \mathbf{U}(\mathbf{X})$  has all partial derivatives of order  $\leq q$  in  $N$ .

18. Calculate all first and second partial derivatives at  $(x_0, y_0) = (1, 1)$  of the functions  $u$  and  $v$  that satisfy

$$\begin{aligned} x^2 + y^2 + u^2 + v^2 &= 3 \\ x + y + u + v &= 3, \quad u(1, 1) = 0, \quad v(1, 1) = 1. \end{aligned}$$

19. Calculate all first and second partial derivatives at  $(x_0, y_0) = (1, -1)$  of the functions  $u$  and  $v$  that satisfy

$$\begin{aligned} u^2 - v^2 &= x - y - 2 \\ 2uv &= x + y - 2, \quad u(1, -1) = -1, \quad v(1, -1) = 1. \end{aligned}$$

20. Suppose that  $f_1, f_2, \dots, f_n$  are continuously differentiable functions of  $\mathbf{X}$  in a region  $S$  in  $\mathbb{R}^n$ ,  $\phi$  is continuously differentiable function of  $\mathbf{U}$  in a region  $T$  of  $\mathbb{R}^n$ ,

$$(f_1(\mathbf{X}), f_2(\mathbf{X}), \dots, f_n(\mathbf{X})) \in T, \quad \mathbf{X} \in S,$$

$$\phi(f_1(\mathbf{X}), f_2(\mathbf{X}), \dots, f_n(\mathbf{X})) = 0, \quad \mathbf{X} \in S,$$

and

$$\sum_{j=1}^n \phi_{u_j}^2(\mathbf{U}) > 0, \quad \mathbf{U} \in T.$$

Show that

$$\frac{\partial(f_1, f_2, \dots, f_n)}{\partial(x_1, x_2, \dots, x_n)} = 0, \quad \mathbf{X} \in S.$$

## CHAPTER 7

### Integrals of Functions of Several Variables

IN THIS CHAPTER we study the integral calculus of real-valued functions of several variables.

SECTION 7.1 defines multiple integrals, first over rectangular parallelepipeds in  $\mathbb{R}^n$  and then over more general sets. The discussion deals with the multiple integral of a function whose discontinuities form a set of Jordan content zero, over a set whose boundary has Jordan content zero.

SECTION 7.2 deals with evaluation of multiple integrals by means of iterated integrals.

SECTION 7.3 begins with the definition of Jordan measurability, followed by a derivation of the rule for change of content under a linear transformation, an intuitive formulation of the rule for change of variables in multiple integrals, and finally a careful statement and proof of the rule. This is a complicated proof.

#### 7.1 DEFINITION AND EXISTENCE OF THE MULTIPLE INTEGRAL

We now consider the Riemann integral of a real-valued function  $f$  defined on a subset of  $\mathbb{R}^n$ , where  $n \geq 2$ . Much of this development will be analogous to the development in Sections 3.1–3 for  $n = 1$ , but there is an important difference: for  $n = 1$ , we considered integrals over closed intervals only, but for  $n > 1$  we must consider more complicated regions of integration. To defer complications due to geometry, we first consider integrals over rectangles in  $\mathbb{R}^n$ , which we now define.

##### Integrals over Rectangles

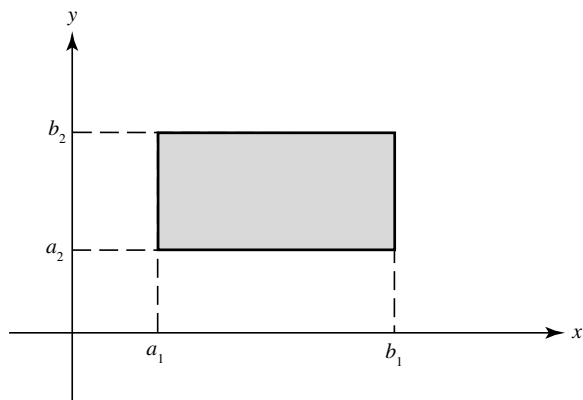
The

$$S_1 \times S_2 \times \cdots \times S_n$$

of subsets  $S_1, S_2, \dots, S_n$  of  $\mathbb{R}$  is the set of points  $(x_1, x_2, \dots, x_n)$  in  $\mathbb{R}^n$  such that  $x_1 \in S_1, x_2 \in S_2, \dots, x_n \in S_n$ . For example, the Cartesian product of the two closed intervals

$$[a_1, b_1] \times [a_2, b_2] = \{(x, y) \mid a_1 \leq x \leq b_1, a_2 \leq y \leq b_2\}$$

is a rectangle in  $\mathbb{R}^2$  with sides parallel to the  $x$ - and  $y$ -axes (Figure 7.1.1).

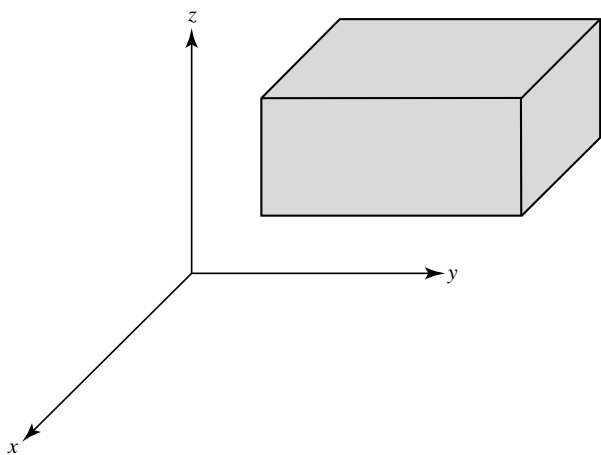


**Figure 7.1.1**

The Cartesian product of three closed intervals

$$[a_1, b_1] \times [a_2, b_2] \times [a_3, b_3] = \{(x, y, z) \mid a_1 \leq x \leq b_1, a_2 \leq y \leq b_2, a_3 \leq z \leq b_3\}$$

is a rectangular parallelepiped in  $\mathbb{R}^3$  with faces parallel to the coordinate axes (Figure 7.1.2).



**Figure 7.1.2**

**Definition 7.1.1** A *coordinate rectangle*  $R$  in  $\mathbb{R}^n$  is the Cartesian product of  $n$  closed intervals; that is,

$$R = [a_1, b_1] \times [a_2, b_2] \times \cdots \times [a_n, b_n].$$

The *content* of  $R$  is

$$V(R) = (b_1 - a_1)(b_2 - a_2) \cdots (b_n - a_n).$$

The numbers  $b_1 - a_1, b_2 - a_2, \dots, b_n - a_n$  are the *edge lengths* of  $R$ . If they are equal, then  $R$  is a *coordinate cube*. If  $a_r = b_r$  for some  $r$ , then  $V(R) = 0$  and we say that  $R$  is *degenerate*; otherwise,  $R$  is *nondegenerate*. ■

If  $n = 1, 2,$  or  $3$ , then  $V(R)$  is, respectively, the length of an interval, the area of a rectangle, or the volume of a rectangular parallelepiped. Henceforth, “rectangle” or “cube” will always mean “coordinate rectangle” or “coordinate cube” unless it is stated otherwise.

If

$$R = [a_1, b_1] \times [a_2, b_2] \times \cdots \times [a_n, b_n]$$

and

$$P_r: a_r = a_{r0} < a_{r1} < \cdots < a_{rm_r} = b_r$$

is a partition of  $[a_r, b_r]$ ,  $1 \leq r \leq n$ , then the set of all rectangles in  $\mathbb{R}^n$  that can be written as

$$[a_{1,j_1-1}, a_{1j_1}] \times [a_{2,j_2-1}, a_{2j_2}] \times \cdots \times [a_{n,j_n-1}, a_{nj_n}], \quad 1 \leq j_r \leq m_r, \quad 1 \leq r \leq n,$$

is a *partition* of  $R$ . We denote this partition by

$$P = P_1 \times P_2 \times \cdots \times P_n \tag{7.1.1}$$

and define its *norm* to be the maximum of the norms of  $P_1, P_2, \dots, P_n$ , as defined in Section 3.1; thus,

$$\|P\| = \max\{\|P_1\|, \|P_2\|, \dots, \|P_n\|\}.$$

Put another way,  $\|P\|$  is the largest of the edge lengths of all the subrectangles in  $P$ .

Geometrically, a rectangle in  $\mathbb{R}^2$  is partitioned by drawing horizontal and vertical lines through it (Figure 7.1.3); in  $\mathbb{R}^3$ , by drawing planes through it parallel to the coordinate axes. Partitioning divides a rectangle  $R$  into finitely many subrectangles that we can number in arbitrary order as  $R_1, R_2, \dots, R_k$ . Sometimes it is convenient to write

$$P = \{R_1, R_2, \dots, R_k\}$$

rather than (7.1.1).

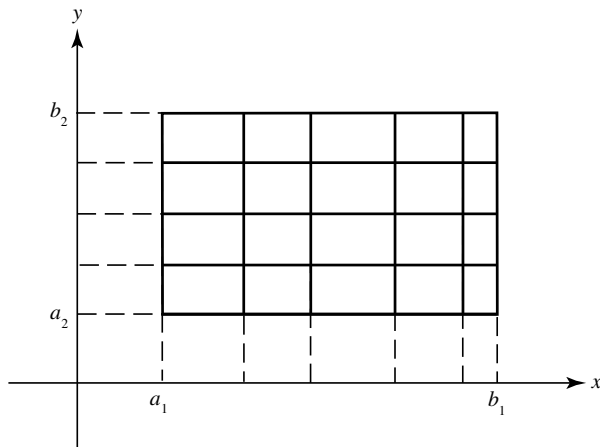


Figure 7.1.3

If  $P = P_1 \times P_2 \times \cdots \times P_n$  and  $P' = P'_1 \times P'_2 \times \cdots \times P'_n$  are partitions of the same rectangle, then  $P'$  is a *refinement* of  $P$  if  $P'_i$  is a refinement of  $P_i$ ,  $1 \leq i \leq n$ , as defined in Section 3.1.

Suppose that  $f$  is a real-valued function defined on a rectangle  $R$  in  $\mathbb{R}^n$ ,  $P = \{R_1, R_2, \dots, R_k\}$  is a partition of  $R$ , and  $\mathbf{X}_j$  is an arbitrary point in  $R_j$ ,  $1 \leq j \leq k$ . Then

$$\sigma = \sum_{j=1}^k f(\mathbf{X}_j)V(R_j)$$

is a *Riemann sum of  $f$  over  $P$* . Since  $\mathbf{X}_j$  can be chosen arbitrarily in  $R_j$ , there are infinitely many Riemann sums for a given function  $f$  over any partition  $P$  of  $R$ .

The following definition is similar to Definition 3.1.1.

**Definition 7.1.2** Let  $f$  be a real-valued function defined on a rectangle  $R$  in  $\mathbb{R}^n$ . We say that  $f$  is *Riemann integrable on  $R$*  if there is a number  $L$  with the following property: For every  $\epsilon > 0$ , there is a  $\delta > 0$  such that

$$|\sigma - L| < \epsilon$$

if  $\sigma$  is any Riemann sum of  $f$  over a partition  $P$  of  $R$  such that  $\|P\| < \delta$ . In this case, we say that  $L$  is the *Riemann integral of  $f$  over  $R$* , and write

$$\int_R f(\mathbf{X}) d\mathbf{X} = L. \quad \blacksquare$$

If  $R$  is degenerate, then Definition 7.1.2 implies that  $\int_R f(\mathbf{X}) d\mathbf{X} = 0$  for any function  $f$  defined on  $R$  (Exercise 7.1.1). Therefore, it should be understood henceforth that whenever we speak of a rectangle in  $\mathbb{R}^n$  we mean a nondegenerate rectangle, unless it is stated to the contrary.

The integral  $\int_R f(\mathbf{X})d\mathbf{X}$  is also written as

$$\int_R f(x, y) d(x, y) \quad (n = 2), \quad \int_R f(x, y, z) d(x, y, z) \quad (n = 3),$$

or

$$\int_R f(x_1, x_2, \dots, x_n) d(x_1, x_2, \dots, x_n) \quad (n \text{ arbitrary}).$$

Here  $d\mathbf{X}$  does not stand for the differential of  $\mathbf{X}$ , as defined in Section 6.2. It merely identifies  $x_1, x_2, \dots, x_n$ , the components of  $\mathbf{X}$ , as the variables of integration. To avoid this minor inconsistency, some authors write simply  $\int_R f$  rather than  $\int_R f(\mathbf{X}) d\mathbf{X}$ .

As in the case where  $n = 1$ , we will say simply “integrable” or “integral” when we mean “Riemann integrable” or “Riemann integral.” If  $n \geq 2$ , we call the integral of Definition 7.1.2 a *multiple integral*; for  $n = 2$  and  $n = 3$  we also call them *double* and *triple integrals*, respectively. When we wish to distinguish between multiple integrals and the integral we studied in Chapter (  $n = 1$  ), we will call the latter an *ordinary* integral.

**Example 7.1.1** Find  $\int_R f(x, y) d(x, y)$ , where

$$R = [a, b] \times [c, d]$$

and

$$f(x, y) = x + y.$$

**Solution** Let  $P_1$  and  $P_2$  be partitions of  $[a, b]$  and  $[c, d]$ ; thus,

$$P_1 : a = x_0 < x_1 < \dots < x_r = b \quad \text{and} \quad P_2 : c = y_0 < y_1 < \dots < y_s = d.$$

A typical Riemann sum of  $f$  over  $P = P_1 \times P_2$  is given by

$$\sigma = \sum_{i=1}^r \sum_{j=1}^s (\xi_{ij} + \eta_{ij})(x_i - x_{i-1})(y_j - y_{j-1}), \quad (7.1.2)$$

where

$$x_{i-1} \leq \xi_{ij} \leq x_i \quad \text{and} \quad y_{j-1} \leq \eta_{ij} \leq y_j. \quad (7.1.3)$$

The midpoints of  $[x_{i-1}, x_i]$  and  $[y_{j-1}, y_j]$  are

$$\bar{x}_i = \frac{x_i + x_{i-1}}{2} \quad \text{and} \quad \bar{y}_j = \frac{y_j + y_{j-1}}{2}, \quad (7.1.4)$$

and (7.1.3) implies that

$$|\xi_{ij} - \bar{x}_i| \leq \frac{x_i - x_{i-1}}{2} \leq \frac{\|P_1\|}{2} \leq \frac{\|P\|}{2} \quad (7.1.5)$$

and

$$|\eta_{ij} - \bar{y}_j| \leq \frac{y_j - y_{j-1}}{2} \leq \frac{\|P_2\|}{2} \leq \frac{\|P\|}{2}. \quad (7.1.6)$$



Now we rewrite (7.1.2) as

$$\begin{aligned} \sigma &= \sum_{i=1}^r \sum_{j=1}^s (\bar{x}_i + \bar{y}_j)(x_i - x_{i-1})(y_j - y_{j-1}) \\ &\quad + \sum_{i=1}^r \sum_{j=1}^s [(\xi_{ij} - \bar{x}_i) + (\eta_{ij} - \bar{y}_j)](x_i - x_{i-1})(y_j - y_{j-1}). \end{aligned} \quad (7.1.7)$$

To find  $\int_R f(x, y) d(x, y)$  from (7.1.7), we recall that

$$\sum_{i=1}^r (x_i - x_{i-1}) = b - a, \quad \sum_{j=1}^s (y_j - y_{j-1}) = d - c \quad (7.1.8)$$

(Example 3.1.1), and

$$\sum_{i=1}^r (x_i^2 - x_{i-1}^2) = b^2 - a^2, \quad \sum_{j=1}^s (y_j^2 - y_{j-1}^2) = d^2 - c^2 \quad (7.1.9)$$

(Example 3.1.2).

Because of (7.1.5) and (7.1.6) the absolute value of the second sum in (7.1.7) does not exceed

$$\begin{aligned} \|P\| \sum_{j=1}^s \sum_{i=1}^r (x_i - x_{i-1})(y_j - y_{j-1}) &= \|P\| \left[ \sum_{i=1}^r (x_i - x_{i-1}) \right] \left[ \sum_{j=1}^s (y_j - y_{j-1}) \right] \\ &= \|P\|(b-a)(d-c) \end{aligned}$$

(see (7.1.8)), so (7.1.7) implies that

$$\left| \sigma - \sum_{i=1}^r \sum_{j=1}^s (\bar{x}_i + \bar{y}_j)(x_i - x_{i-1})(y_j - y_{j-1}) \right| \leq \|P\|(b-a)(d-c). \quad (7.1.10)$$

It now follows that

$$\begin{aligned} \sum_{i=1}^r \sum_{j=1}^s \bar{x}_i (x_i - x_{i-1})(y_j - y_{j-1}) &= \left[ \sum_{i=1}^r \bar{x}_i (x_i - x_{i-1}) \right] \left[ \sum_{j=1}^s (y_j - y_{j-1}) \right] \\ &= (d-c) \sum_{i=1}^r \bar{x}_i (x_i - x_{i-1}) \quad (\text{from (7.1.8)}) \\ &= \frac{d-c}{2} \sum_{i=1}^r (x_i^2 - x_{i-1}^2) \quad (\text{from (7.1.4)}) \\ &= \frac{d-c}{2} (b^2 - a^2) \quad (\text{from (7.1.9)}). \end{aligned}$$

Similarly,

$$\sum_{i=1}^r \sum_{j=1}^s \bar{y}_j (x_i - x_{i-1})(y_j - y_{j-1}) = \frac{b-a}{2} (d^2 - c^2).$$

Therefore, (7.1.10) can be written as

$$\left| \sigma - \frac{d-c}{2}(b^2 - a^2) - \frac{b-a}{2}(d^2 - c^2) \right| \leq \|P\|(b-a)(d-c).$$

Since the right side can be made as small as we wish by choosing  $\|P\|$  sufficiently small,

$$\int_R (x+y) d(x,y) = \frac{1}{2} [(d-c)(b^2 - a^2) + (b-a)(d^2 - c^2)].$$

### Upper and Lower Integrals

The following theorem is analogous to Theorem 3.1.2.

**Theorem 7.1.3** *If  $f$  is unbounded on the nondegenerate rectangle  $R$  in  $\mathbb{R}^n$ , then  $f$  is not integrable on  $R$ .*

**Proof** We will show that if  $f$  is unbounded on  $R$ ,  $P = \{R_1, R_2, \dots, R_k\}$  is any partition of  $R$ , and  $M > 0$ , then there are Riemann sums  $\sigma$  and  $\sigma'$  of  $f$  over  $P$  such that

$$|\sigma - \sigma'| \geq M. \quad (7.1.11)$$

This implies that  $f$  cannot satisfy Definition 7.1.2. (Why?)

Let

$$\sigma = \sum_{j=1}^k f(\mathbf{X}_j)V(R_j)$$

be a Riemann sum of  $f$  over  $P$ . There must be an integer  $i$  in  $\{1, 2, \dots, k\}$  such that

$$|f(\mathbf{X}) - f(\mathbf{X}_i)| \geq \frac{M}{V(R_i)} \quad (7.1.12)$$

for some  $\mathbf{X}$  in  $R_i$ , because if this were not so, we would have

$$|f(\mathbf{X}) - f(\mathbf{X}_j)| < \frac{M}{V(R_j)}, \quad \mathbf{X} \in R_j, \quad 1 \leq j \leq k.$$

If this is so, then

$$\begin{aligned} |f(\mathbf{X})| &= |f(\mathbf{X}_j) + f(\mathbf{X}) - f(\mathbf{X}_j)| \leq |f(\mathbf{X}_j)| + |f(\mathbf{X}) - f(\mathbf{X}_j)| \\ &\leq |f(\mathbf{X}_j)| + \frac{M}{V(R_j)}, \quad \mathbf{X} \in R_j, \quad 1 \leq j \leq k. \end{aligned}$$

However, this implies that

$$|f(\mathbf{X})| \leq \max \left\{ |f(\mathbf{X}_j)| + \frac{M}{V(R_j)} \mid 1 \leq j \leq k \right\}, \quad \mathbf{X} \in R,$$

which contradicts the assumption that  $f$  is unbounded on  $R$ .

Now suppose that  $\mathbf{X}$  satisfies (7.1.12), and consider the Riemann sum

$$\sigma' = \sum_{j=1}^n f(\mathbf{X}'_j) V(R_j)$$

over the same partition  $P$ , where

$$\mathbf{X}'_j = \begin{cases} \mathbf{X}_j, & j \neq i, \\ \mathbf{X}, & j = i. \end{cases}$$

Since

$$|\sigma - \sigma'| = |f(\mathbf{X}) - f(\mathbf{X}_i)| V(R_i),$$

(7.1.12) implies (7.1.11). ■

Because of Theorem 7.1.3, we need consider only bounded functions in connection with Definition 7.1.2. As in the case where  $n = 1$ , it is now convenient to define the upper and lower integrals of a bounded function over a rectangle. The following definition is analogous to Definition 3.1.3.

**Definition 7.1.4** If  $f$  is bounded on a rectangle  $R$  in  $\mathbb{R}^n$  and  $P = \{R_1, R_2, \dots, R_k\}$  is a partition of  $R$ , let

$$M_j = \sup_{\mathbf{X} \in R_j} f(\mathbf{X}), \quad m_j = \inf_{\mathbf{X} \in R_j} f(\mathbf{X}).$$

The *upper sum* of  $f$  over  $P$  is

$$S(P) = \sum_{j=1}^k M_j V(R_j),$$

and the *upper integral of  $f$  over  $R$* , denoted by

$$\overline{\int}_R f(\mathbf{X}) d\mathbf{X},$$

is the infimum of all upper sums. The *lower sum of  $f$  over  $P$*  is

$$s(P) = \sum_{j=1}^k m_j V(R_j),$$

and the *lower integral of  $f$  over  $R$* , denoted by

$$\underline{\int}_R f(\mathbf{X}) d\mathbf{X},$$

is the supremum of all lower sums. ■

The following theorem is analogous to Theorem 3.1.4.

**Theorem 7.1.5** Let  $f$  be bounded on a rectangle  $R$  and let  $\mathbf{P}$  be a partition of  $R$ . Then

- (a) The upper sum  $S(\mathbf{P})$  of  $f$  over  $\mathbf{P}$  is the supremum of the set of all Riemann sums of  $f$  over  $\mathbf{P}$ .
- (b) The lower sum  $s(\mathbf{P})$  of  $f$  over  $\mathbf{P}$  is the infimum of the set of all Riemann sums of  $f$  over  $\mathbf{P}$ .

**Proof** Exercise 7.1.5.

If

$$m \leq f(\mathbf{X}) \leq M \quad \text{for } \mathbf{X} \text{ in } R,$$

then

$$mV(R) \leq s(P) \leq S(P) \leq MV(R);$$

therefore,  $\overline{\int}_R f(\mathbf{X}) d\mathbf{X}$  and  $\underline{\int}_R f(\mathbf{X}) d\mathbf{X}$  exist, are unique, and satisfy the inequalities

$$mV(R) \leq \overline{\int}_R f(\mathbf{X}) d\mathbf{X} \leq MV(R)$$

and

$$mV(R) \leq \underline{\int}_R f(\mathbf{X}) d\mathbf{X} \leq MV(R).$$

The upper and lower integrals are also written as

$$\overline{\int}_R f(x, y) d(x, y) \quad \text{and} \quad \underline{\int}_R f(x, y) d(x, y) \quad (n = 2),$$

$$\overline{\int}_R f(x, y, z) d(x, y, z) \quad \text{and} \quad \underline{\int}_R f(x, y, z) d(x, y, z) \quad (n = 3),$$

or

$$\overline{\int}_R f(x_1, x_2, \dots, x_n) d(x_1, x_2, \dots, x_n)$$

and

$$\underline{\int}_R f(x_1, x_2, \dots, x_n) d(x_1, x_2, \dots, x_n) \quad (n \text{ arbitrary}).$$

**Example 7.1.2** Find  $\underline{\int}_R f(x, y) d(x, y)$  and  $\overline{\int}_R f(x, y) d(x, y)$ , with  $R = [a, b] \times [c, d]$  and

$$f(x, y) = x + y,$$

as in Example 7.1.1. ■

**Solution** Let  $P_1$  and  $P_2$  be partitions of  $[a, b]$  and  $[c, d]$ ; thus,

$$P_1 : a = x_0 < x_1 < \dots < x_r = b \quad \text{and} \quad P_2 : c = y_0 < y_1 < \dots < y_s = d.$$

The maximum and minimum values of  $f$  on the rectangle  $[x_{i-1}, x_i] \times [y_{j-1}, y_j]$  are  $x_i + y_j$  and  $x_{i-1} + y_{j-1}$ , respectively. Therefore,

$$S(P) = \sum_{i=1}^r \sum_{j=1}^s (x_i + y_j)(x_i - x_{i-1})(y_j - y_{j-1}) \quad (7.1.13)$$

and

$$s(P) = \sum_{i=1}^r \sum_{j=1}^s (x_{i-1} + y_{j-1})(x_i - x_{i-1})(y_j - y_{j-1}). \quad (7.1.14)$$

By substituting

$$x_i + y_j = \frac{1}{2}[(x_i + x_{i-1}) + (y_j + y_{j-1}) + (x_i - x_{i-1}) + (y_j - y_{j-1})]$$

into (7.1.13), we find that

$$S(P) = \frac{1}{2}(\Sigma_1 + \Sigma_2 + \Sigma_3 + \Sigma_4), \quad (7.1.15)$$

where

$$\begin{aligned} \Sigma_1 &= \sum_{i=1}^r (x_i^2 - x_{i-1}^2) \sum_{j=1}^s (y_j - y_{j-1}) = (b^2 - a^2)(d - c), \\ \Sigma_2 &= \sum_{i=1}^r (x_i - x_{i-1}) \sum_{j=1}^s (y_j^2 - y_{j-1}^2) = (b - a)(d^2 - c^2), \\ \Sigma_3 &= \sum_{i=1}^r (x_i - x_{i-1})^2 \sum_{j=1}^s (y_j - y_{j-1}) \leq \|P\|(b - a)(d - c), \\ \Sigma_4 &= \sum_{i=1}^r (x_i - x_{i-1}) \sum_{j=1}^s (y_j - y_{j-1})^2 \leq \|P\|(b - a)(d - c). \end{aligned}$$

Substituting these four results into (7.1.15) shows that

$$I < S(P) < I + \|P\|(b - a)(d - c),$$

where

$$I = \frac{(d - c)(b^2 - a^2) + (b - a)(d^2 - c^2)}{2}.$$

From this, we see that

$$\overline{\int}_R (x + y) d(x, y) = I.$$

After substituting

$$x_{i-1} + y_{j-1} = \frac{1}{2}[(x_i + x_{i-1}) + (y_j + y_{j-1}) - (x_i - x_{i-1}) - (y_j - y_{j-1})]$$

into (7.1.14), a similar argument shows that

$$I - \|P\|(b - a)(d - c) < s(P) < I,$$

so

$$\int_R (x + y) d(x, y) = I. \quad \blacksquare$$

We now prove an analog of Lemma 3.2.1.

**Lemma 7.1.6** Suppose that  $|f(\mathbf{X})| \leq M$  if  $\mathbf{X}$  is in the rectangle

$$R = [a_1, b_1] \times [a_2, b_2] \times \cdots \times [a_n, b_n].$$

Let  $P = P_1 \times P_2 \times \cdots \times P_n$  and  $P' = P'_1 \times P'_2 \times \cdots \times P'_n$  be partitions of  $R$ , where  $P'_j$  is obtained by adding  $r_j$  partition points to  $P_j$ ,  $1 \leq j \leq n$ . Then

$$S(P) \geq S(P') \geq S(P) - 2MV(R) \left( \sum_{j=1}^n \frac{r_j}{b_j - a_j} \right) \|P\| \quad (7.1.16)$$

and

$$s(P) \leq s(P') \leq s(P) + 2MV(R) \left( \sum_{j=1}^n \frac{r_j}{b_j - a_j} \right) \|P\|. \quad (7.1.17)$$

**Proof** We will prove (7.1.16) and leave the proof of (7.1.17) to you (Exercise 7.1.7). First suppose that  $P'_1$  is obtained by adding one point to  $P_1$ , and  $P'_j = P_j$  for  $2 \leq j \leq n$ . If  $P_r$  is defined by

$$P_r : a_r = a_{r0} < a_{r1} < \cdots < a_{rm_r} = b_r, \quad 1 \leq r \leq n,$$

then a typical subrectangle of  $P$  is of the form

$$R_{j_1 j_2 \cdots j_n} = [a_{1, j_1 - 1}, a_{1 j_1}] \times [a_{2, j_2 - 1}, a_{2 j_2}] \times \cdots \times [a_{n, j_n - 1}, a_{n j_n}].$$

Let  $c$  be the additional point introduced into  $P_1$  to obtain  $P'_1$ , and suppose that

$$a_{1, k-1} < c < a_{1 k}.$$

If  $j_1 \neq k$ , then  $R_{j_1 j_2 \cdots j_n}$  is common to  $P$  and  $P'$ , so the terms associated with it in  $S(P')$  and  $S(P)$  cancel in the difference  $S(P) - S(P')$ . To analyze the terms that do not cancel, define

$$R_{kj_2 \cdots j_n}^{(1)} = [a_{1, k-1}, c] \times [a_{2, j_2 - 1}, a_{2 j_2}] \times \cdots \times [a_{n, j_n - 1}, a_{n j_n}],$$

$$R_{kj_2 \cdots j_n}^{(2)} = [c, a_{1 k}] \times [a_{2, j_2 - 1}, a_{2 j_2}] \times \cdots \times [a_{n, j_n - 1}, a_{n j_n}],$$

$$M_{kj_2 \cdots j_n} = \sup \{ f(\mathbf{X}) \mid \mathbf{X} \in R_{kj_2 \cdots j_n} \} \quad (7.1.18)$$

and

$$M_{kj_2 \cdots j_n}^{(i)} = \sup \{ f(\mathbf{X}) \mid \mathbf{X} \in R_{kj_2 \cdots j_n}^{(i)} \}, \quad i = 1, 2. \quad (7.1.19)$$

Then  $S(P) - S(P')$  is the sum of terms of the form

$$\left[ M_{kj_2 \dots j_n}(a_{1k} - a_{1,k-1}) - M_{kj_2 \dots j_n}^{(1)}(c - a_{1,k-1}) - M_{kj_2 \dots j_n}^{(2)}(a_{1k} - c) \right] \times (a_{2j_2} - a_{2,j_2-1}) \cdots (a_{nj_n} - a_{n,j_n-1}). \quad (7.1.20)$$

The terms within the brackets can be rewritten as

$$(M_{kj_2 \dots j_n} - M_{kj_2 \dots j_n}^{(1)})(c - a_{1,k-1}) + (M_{kj_2 \dots j_n} - M_{kj_2 \dots j_n}^{(2)})(a_{1k} - c), \quad (7.1.21)$$

which is nonnegative, because of (7.1.18) and (7.1.19). Therefore,

$$S(P') \leq S(P). \quad (7.1.22)$$

Moreover, the quantity in (7.1.21) is not greater than  $2M(a_{1k} - a_{1,k-1})$ , so (7.1.20) implies that the general surviving term in  $S(P) - S(P')$  is not greater than

$$2M \|P\| (a_{2j_2} - a_{2,j_2-1}) \cdots (a_{nj_n} - a_{n,j_n-1}).$$

The sum of these terms as  $j_2, \dots, j_n$  assume all possible values  $1 \leq j_i \leq m_i$ ,  $2 \leq i \leq n$ , is

$$2M \|P\| (b_2 - a_2) \cdots (b_n - a_n) = \frac{2M \|P\| V(R)}{b_1 - a_1}.$$

This implies that

$$S(P) \leq S(P') + \frac{2M \|P\| V(R)}{b_1 - a_1}.$$

This and (7.1.22) imply (7.1.16) for  $r_1 = 1$  and  $r_2 = \cdots = r_n = 0$ .

Similarly, if  $r_i = 1$  for some  $i$  in  $\{1, \dots, n\}$  and  $r_j = 0$  if  $j \neq i$ , then

$$S(P) \leq S(P') + \frac{2M \|P\| V(R)}{b_i - a_i}.$$

To obtain (7.1.16) in the general case, repeat this argument  $r_1 + r_2 + \cdots + r_n$  times, as in the proof of Lemma 3.2.1. ■

Lemma 7.1.6 implies the following theorems and lemma, with proofs analogous to the proofs of their counterparts in Section 3.2.

**Theorem 7.1.7** *If  $f$  is bounded on a rectangle  $R$ , then*

$$\int_{\underline{R}} f(\mathbf{X}) d\mathbf{X} \leq \int_{\overline{R}} f(\mathbf{X}) d\mathbf{X}.$$

**Proof** Exercise 7.1.8.

The next theorem is analogous to Theorem 3.2.3.

**Theorem 7.1.8** *If  $f$  is integrable on a rectangle  $R$ , then*

$$\int_{\underline{R}} f(\mathbf{X}) d\mathbf{X} = \int_{\overline{R}} f(\mathbf{X}) d\mathbf{X} = \int_R f(\mathbf{X}) d\mathbf{X}.$$

**Proof** Exercise 7.1.9.

**Lemma 7.1.9** *If  $f$  is bounded on a rectangle  $R$  and  $\epsilon > 0$ , there is a  $\delta > 0$  such that*

$$\overline{\int_R} f(\mathbf{X}) d\mathbf{X} \leq S(P) < \overline{\int_R} f(\mathbf{X}) d\mathbf{X} + \epsilon$$

and

$$\underline{\int_R} f(\mathbf{X}) d\mathbf{X} \geq s(P) > \underline{\int_R} f(\mathbf{X}) d\mathbf{X} - \epsilon$$

if  $\|P\| < \delta$ .

**Proof** Exercise 7.1.10.

The next theorem is analogous to Theorem 3.2.5.

**Theorem 7.1.10** *If  $f$  is bounded on a rectangle  $R$  and*

$$\underline{\int_R} f(\mathbf{X}) d\mathbf{X} = \overline{\int_R} f(\mathbf{X}) d\mathbf{X} = L,$$

then  $f$  is integrable on  $R$ , and

$$\int_R f(\mathbf{X}) d\mathbf{X} = L.$$

**Proof** Exercise 7.1.11.

Theorems 7.1.8 and 7.1.10 imply the following theorem, which is analogous to Theorem 3.2.6.

**Theorem 7.1.11** *A bounded function  $f$  is integrable on a rectangle  $R$  if and only if*

$$\underline{\int_R} f(\mathbf{X}) d\mathbf{X} = \overline{\int_R} f(\mathbf{X}) d\mathbf{X}.$$

The next theorem translates this into a test that can be conveniently applied. It is analogous to Theorem 3.2.7.

**Theorem 7.1.12** *If  $f$  is bounded on a rectangle  $R$ , then  $f$  is integrable on  $R$  if and only if for every  $\epsilon > 0$  there is a partition  $P$  of  $R$  such that*

$$S(P) - s(P) < \epsilon.$$

**Proof** Exercise 7.1.12.

Theorem 7.1.12 provides a useful criterion for integrability. The next theorem is an important application. It is analogous to Theorem 3.2.8.

**Theorem 7.1.13** *If  $f$  is continuous on a rectangle  $R$  in  $\mathbb{R}^n$ , then  $f$  is integrable on  $R$ .*



**Proof** Let  $\epsilon > 0$ . Since  $f$  is uniformly continuous on  $R$  (Theorem 5.2.14), there is a  $\delta > 0$  such that

$$|f(\mathbf{X}) - f(\mathbf{X}')| < \frac{\epsilon}{V(R)} \quad (7.1.23)$$

if  $\mathbf{X}$  and  $\mathbf{X}'$  are in  $R$  and  $|\mathbf{X} - \mathbf{X}'| < \delta$ . Let  $P = \{R_1, R_2, \dots, R_k\}$  be a partition of  $R$  with  $\|P\| < \delta/\sqrt{n}$ . Since  $f$  is continuous on  $R$ , there are points  $\mathbf{X}_j$  and  $\mathbf{X}'_j$  in  $R_j$  such that

$$f(\mathbf{X}_j) = M_j = \sup_{\mathbf{X} \in R_j} f(\mathbf{X}) \quad \text{and} \quad f(\mathbf{X}'_j) = m_j = \inf_{\mathbf{X} \in R_j} f(\mathbf{X})$$

(Theorem 5.2.12). Therefore,

$$S(\mathbf{P}) - s(\mathbf{P}) = \sum_{j=1}^k (f(\mathbf{X}_j) - f(\mathbf{X}'_j))V(R_j).$$

Since  $\|P\| < \delta/\sqrt{n}$ ,  $|\mathbf{X}_j - \mathbf{X}'_j| < \delta$ , and, from (7.1.23) with  $\mathbf{X} = \mathbf{X}_j$  and  $\mathbf{X}' = \mathbf{X}'_j$ ,

$$S(\mathbf{P}) - s(\mathbf{P}) < \frac{\epsilon}{V(R)} \sum_{j=1}^k V(R_j) = \epsilon.$$

Hence,  $f$  is integrable on  $R$ , by Theorem 7.1.12.

### Sets with Zero Content

The next definition will enable us to establish the existence of  $\int_R f(\mathbf{X}) d\mathbf{X}$  in cases where  $f$  is bounded on the rectangle  $R$ , but is not necessarily continuous for all  $\mathbf{X}$  in  $R$ .

**Definition 7.1.14** A subset  $E$  of  $\mathbb{R}^n$  has zero content if for each  $\epsilon > 0$  there is a finite set of rectangles  $T_1, T_2, \dots, T_m$  such that

$$E \subset \bigcup_{j=1}^m T_j \quad (7.1.24)$$

and

$$\sum_{j=1}^m V(T_j) < \epsilon. \quad (7.1.25)$$

**Example 7.1.3** Since the empty set is contained in every rectangle, the empty set has zero content. If  $E$  consists of finitely many points  $\mathbf{X}_1, \mathbf{X}_2, \dots, \mathbf{X}_m$ , then  $\mathbf{X}_j$  can be enclosed in a rectangle  $T_j$  such that

$$V(T_j) < \frac{\epsilon}{m}, \quad 1 \leq j \leq m.$$

Then (7.1.24) and (7.1.25) hold, so  $E$  has zero content.

**Example 7.1.4** Any bounded set  $E$  with only finitely many limit points has zero content. To see this, we first observe that if  $E$  has no limit points, then it must be finite, by the Bolzano–Weierstrass theorem (Theorem 1.3.8), and therefore must have zero content, by Example 7.1.3. Now suppose that the limit points of  $E$  are  $\mathbf{X}_1, \mathbf{X}_2, \dots, \mathbf{X}_m$ . Let  $R_1, R_2, \dots, R_m$  be rectangles such that  $\mathbf{X}_i \in R_i^0$  and

$$V(R_i) < \frac{\epsilon}{2m}, \quad 1 \leq i \leq m. \quad (7.1.26)$$

The set of points of  $E$  that are not in  $\cup_{j=1}^m R_j$  has no limit points (why?) and, being bounded, must be finite (again by the Bolzano–Weierstrass theorem). If this set contains  $p$  points, then it can be covered by rectangles  $R'_1, R'_2, \dots, R'_p$  with

$$V(R'_j) < \frac{\epsilon}{2p}, \quad 1 \leq j \leq p. \quad (7.1.27)$$

Now,

$$E \subset \left( \bigcup_{i=1}^m R_i \right) \cup \left( \bigcup_{j=1}^p R'_j \right)$$

and, from (7.1.26) and (7.1.27),

$$\sum_{i=1}^m V(R_i) + \sum_{j=1}^p V(R'_j) < \epsilon.$$

**Example 7.1.5** If  $f$  is continuous on  $[a, b]$ , then the curve

$$y = f(x), \quad a \leq x \leq b \quad (7.1.28)$$

(that is, the set  $\{(x, y) \mid y = f(x), a \leq x \leq b\}$ ), has zero content in  $\mathbb{R}^2$ . To see this, suppose that  $\epsilon > 0$ , and choose  $\delta > 0$  such that

$$|f(x) - f(x')| < \epsilon \quad \text{if } x, x' \in [a, b] \quad \text{and} \quad |x - x'| < \delta. \quad (7.1.29)$$

This is possible because  $f$  is uniformly continuous on  $[a, b]$  (Theorem 2.2.12). Let

$$P : a = x_0 < x_1 < \dots < x_n = b$$

be a partition of  $[a, b]$  with  $\|P\| < \delta$ , and choose  $\xi_1, \xi_2, \dots, \xi_n$  so that

$$x_{i-1} \leq \xi_i \leq x_i, \quad 1 \leq i \leq n.$$

Then, from (7.1.29),

$$|f(x) - f(\xi_i)| < \epsilon \quad \text{if } x_{i-1} \leq x \leq x_i.$$

This means that every point on the curve (7.1.28) above the interval  $[x_{i-1}, x_i]$  is in a rectangle with area  $2\epsilon(x_i - x_{i-1})$  (Figure 7.1.4). Since the total area of these rectangles is  $2\epsilon(b - a)$ , the curve has zero content.

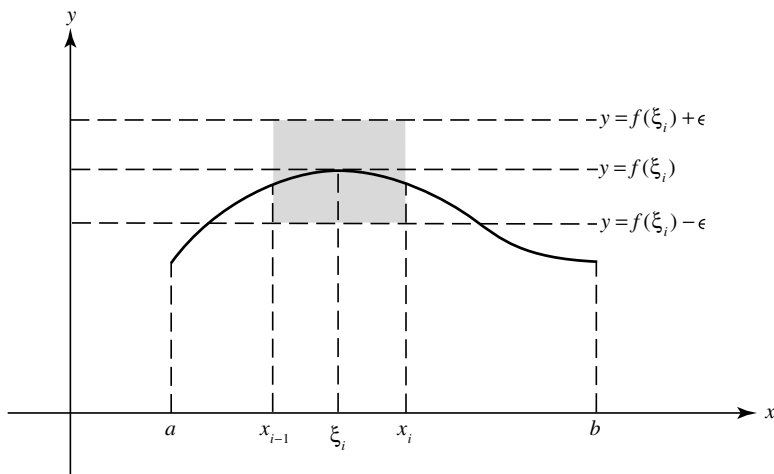


Figure 7.1.4

The next lemma follows immediately from Definition 7.1.14.

**Lemma 7.1.15** *The union of finitely many sets with zero content has zero content.*

The following theorem will enable us to define multiple integrals over more general subsets of  $\mathbb{R}^n$ .

**Theorem 7.1.16** *Suppose that  $f$  is bounded on a rectangle*

$$R = [a_1, b_1] \times [a_2, b_2] \times \cdots \times [a_n, b_n] \quad (7.1.30)$$

*and continuous except on a subset  $E$  of  $R$  with zero content. Then  $f$  is integrable on  $R$ .*

**Proof** Suppose that  $\epsilon > 0$ . Since  $E$  has zero content, there are rectangles  $T_1, T_2, \dots, T_m$  such that

$$E \subset \bigcup_{j=1}^m T_j \quad (7.1.31)$$

and

$$\sum_{j=1}^m V(T_j) < \epsilon. \quad (7.1.32)$$

We may assume that  $T_1, T_2, \dots, T_m$  are contained in  $R$ , since, if not, their intersections with  $R$  would be contained in  $R$ , and still satisfy (7.1.31) and (7.1.32). We may also assume that if  $T$  is any rectangle such that

$$T \cap \left( \bigcup_{j=1}^m T_j^0 \right) = \emptyset, \quad \text{then} \quad T \cap E = \emptyset \quad (7.1.33)$$

since if this were not so, we could make it so by enlarging  $T_1, T_2, \dots, T_m$  slightly while maintaining (7.1.32). Now suppose that

$$T_j = [a_{1j}, b_{1j}] \times [a_{2j}, b_{2j}] \times \cdots \times [a_{nj}, b_{nj}], \quad 1 \leq j \leq m,$$

let  $P_{i0}$  be the partition of  $[a_i, b_i]$  (see (7.1.30)) with partition points

$$a_i, b_i, a_{i1}, b_{i1}, a_{i2}, b_{i2}, \dots, a_{im}, b_{im}$$

(these are not in increasing order),  $1 \leq i \leq n$ , and let

$$P_0 = P_{10} \times P_{20} \times \cdots \times P_{n0}.$$

Then  $P_0$  consists of rectangles whose union equals  $\cup_{j=1}^m T_j$  and other rectangles  $T'_1, T'_2, \dots, T'_k$  that do not intersect  $E$ . (We need (7.1.33) to be sure that  $T'_i \cap E = \emptyset, 1 \leq i \leq k$ .) If we let

$$B = \bigcup_{j=1}^m T_j \quad \text{and} \quad C = \bigcup_{i=1}^k T'_i,$$

then  $R = B \cup C$  and  $f$  is continuous on the compact set  $C$ . If  $P = \{R_1, R_2, \dots, R_k\}$  is a refinement of  $P_0$ , then every subrectangle  $R_j$  of  $P$  is contained entirely in  $B$  or entirely in  $C$ . Therefore, we can write

$$S(P) - s(P) = \Sigma_1(M_j - m_j)V(R_j) + \Sigma_2(M_j - m_j)V(R_j), \quad (7.1.34)$$

where  $\Sigma_1$  and  $\Sigma_2$  are summations over values of  $j$  for which  $R_j \subset B$  and  $R_j \subset C$ , respectively. Now suppose that

$$|f(\mathbf{X})| \leq M \quad \text{for } \mathbf{X} \text{ in } R.$$

Then

$$\Sigma_1(M_j - m_j)V(R_j) \leq 2M \Sigma_1 V(R_j) = 2M \sum_{j=1}^m V(T_j) < 2M\epsilon, \quad (7.1.35)$$

from (7.1.32). Since  $f$  is uniformly continuous on the compact set  $C$  (Theorem 5.2.14), there is a  $\delta > 0$  such that  $M_j - m_j < \epsilon$  if  $\|P\| < \delta$  and  $R_j \subset C$ ; hence,

$$\Sigma_2(M_j - m_j)V(R_j) < \epsilon \Sigma_2 V(R_j) \leq \epsilon V(R).$$

This, (7.1.34), and (7.1.35) imply that

$$S(P) - s(P) < [2M + V(R)]\epsilon$$

if  $\|P\| < \delta$  and  $P$  is a refinement of  $P_0$ . Therefore, Theorem 7.1.12 implies that  $f$  is integrable on  $R$ . ■

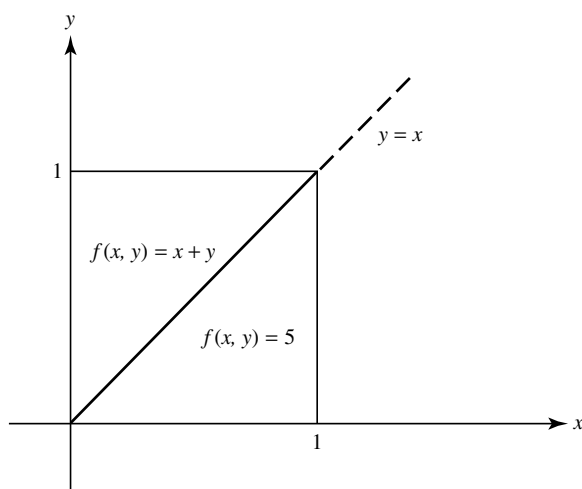
**Example 7.1.6** The function

$$f(x, y) = \begin{cases} x + y, & 0 \leq x < y \leq 1, \\ 5, & 0 \leq y \leq x \leq 1, \end{cases}$$

is continuous on  $R = [0, 1] \times [0, 1]$  except on the line segment

$$y = x, \quad 0 \leq x \leq 1$$

(Figure 7.1.5). Since the line segment has zero content (Example 7.1.5),  $f$  is integrable on  $R$ .



**Figure 7.1.5**

### Integrals over More General Subsets of $\mathbb{R}^n$

We can now define the integral of a bounded function over more general subsets of  $\mathbb{R}^n$ .

**Definition 7.1.17** Suppose that  $f$  is bounded on a bounded subset of  $S$  of  $\mathbb{R}^n$ , and let

$$f_S(\mathbf{X}) = \begin{cases} f(\mathbf{X}), & \mathbf{X} \in S, \\ 0, & \mathbf{X} \notin S. \end{cases} \quad (7.1.36)$$

Let  $R$  be a rectangle containing  $S$ . Then *the integral of  $f$  over  $S$*  is defined to be

$$\int_S f(\mathbf{X}) d\mathbf{X} = \int_R f_S(\mathbf{X}) d\mathbf{X}$$

if  $\int_R f_S(\mathbf{X}) d\mathbf{X}$  exists. ■

To see that this definition makes sense, we must show that if  $R_1$  and  $R_2$  are two rectangles containing  $S$  and  $\int_{R_1} f_S(\mathbf{X}) d\mathbf{X}$  exists, then so does  $\int_{R_2} f_S(\mathbf{X}) d\mathbf{X}$ , and the two integrals are equal. The proof of this is sketched in Exercise 7.1.27.

**Definition 7.1.18** If  $S$  is a bounded subset of  $\mathbb{R}^n$  and the integral  $\int_S d\mathbf{X}$  (with integrand  $f \equiv 1$ ) exists, we call  $\int_S d\mathbf{X}$  the *content* (also, *area* if  $n = 2$  or *volume* if  $n = 3$ ) of  $S$ , and denote it by  $V(S)$ ; thus,

$$V(S) = \int_S d\mathbf{X}.$$

**Theorem 7.1.19** Suppose that  $f$  is bounded on a bounded set  $S$  and continuous except on a subset  $E$  of  $S$  with zero content. Suppose also that  $\partial S$  has zero content. Then  $f$  is integrable on  $S$ .

**Proof** Let  $f_S$  be as in (7.1.36). Since a discontinuity of  $f_S$  is either a discontinuity of  $f$  or a point of  $\partial S$ , the set of discontinuities of  $f_S$  is the union of two sets of zero content and therefore is of zero content (Lemma 7.1.15). Therefore,  $f_S$  is integrable on any rectangle containing  $S$  (from Theorem 7.1.16), and consequently on  $S$  (Definition 7.1.17). ■

## Differentiable Surfaces

*Differentiable surfaces*, defined as follows, form an important class of sets of zero content in  $\mathbb{R}^n$ .

**Definition 7.1.20** A *differentiable surface*  $S$  in  $\mathbb{R}^n$  ( $n > 1$ ) is the image of a compact subset  $D$  of  $\mathbb{R}^m$ , where  $m < n$ , under a continuously differentiable transformation  $\mathbf{G} : \mathbb{R}^m \rightarrow \mathbb{R}^n$ . If  $m = 1$ ,  $S$  is also called a *differentiable curve*.

**Example 7.1.7** The circle

$$\{(x, y) \mid x^2 + y^2 = 9\}$$

is a differentiable curve in  $\mathbb{R}^2$ , since it is the image of  $D = [0, 2\pi]$  under the continuously differentiable transformation  $G : \mathbb{R} \rightarrow \mathbb{R}^2$  defined by

$$\mathbf{X} = \mathbf{G}(\theta) = \begin{bmatrix} 3 \cos \theta \\ 3 \sin \theta \end{bmatrix}.$$

**Example 7.1.8** The sphere

$$\{(x, y, z) \mid x^2 + y^2 + z^2 = 4\}$$

is a differentiable surface in  $\mathbb{R}^3$ , since it is the image of

$$D = \{(\theta, \phi) \mid 0 \leq \theta \leq 2\pi, -\pi/2 \leq \phi \leq \pi/2\}$$

under the continuously differentiable transformation  $\mathbf{G} : \mathbb{R}^2 \rightarrow \mathbb{R}^3$  defined by

$$\mathbf{X} = \mathbf{G}(\theta, \phi) = \begin{bmatrix} 2 \cos \theta \cos \phi \\ 2 \sin \theta \cos \phi \\ 2 \sin \phi \end{bmatrix}.$$

**Example 7.1.9** The set

$$\{(x_1, x_2, x_3, x_4) \mid x_i \geq 0 \ (i = 1, 2, 3, 4), \ x_1 + x_2 = 1, \ x_3 + x_4 = 1\}$$

is a differentiable surface in  $\mathbb{R}^4$ , since it is the image of  $D = [0, 1] \times [0, 1]$  under the continuously differentiable transformation  $\mathbf{G} : \mathbb{R}^2 \rightarrow \mathbb{R}^4$  defined by

$$\mathbf{X} = \mathbf{G}(u, v) = \begin{bmatrix} u \\ 1 - u \\ v \\ 1 - v \end{bmatrix}.$$

**Theorem 7.1.21** A differentiable surface in  $\mathbb{R}^n$  has zero content.

**Proof** Let  $S$ ,  $D$ , and  $\mathbf{G}$  be as in Definition 7.1.20. From Lemma 6.2.7, there is a constant  $M$  such that

$$|\mathbf{G}(\mathbf{X}) - \mathbf{G}(\mathbf{Y})| \leq M|\mathbf{X} - \mathbf{Y}| \quad \text{if } \mathbf{X}, \mathbf{Y} \in D. \quad (7.1.37)$$

Since  $D$  is bounded,  $D$  is contained in a cube

$$C = [a_1, b_1] \times [a_2, b_2] \times \cdots \times [a_m, b_m],$$

where

$$b_i - a_i = L, \quad 1 \leq i \leq m.$$

Suppose that we partition  $C$  into  $N^m$  smaller cubes by partitioning each of the intervals  $[a_i, b_i]$  into  $N$  equal subintervals. Let  $R_1, R_2, \dots, R_k$  be the smaller cubes so produced that contain points of  $D$ , and select points  $\mathbf{X}_1, \mathbf{X}_2, \dots, \mathbf{X}_k$  such that  $\mathbf{X}_i \in D \cap R_i$ ,  $1 \leq i \leq k$ . If  $\mathbf{Y} \in D \cap R_i$ , then (7.1.37) implies that

$$|\mathbf{G}(\mathbf{X}_i) - \mathbf{G}(\mathbf{Y})| \leq M|\mathbf{X}_i - \mathbf{Y}|. \quad (7.1.38)$$

Since  $\mathbf{X}_i$  and  $\mathbf{Y}$  are both in the cube  $R_i$  with edge length  $L/N$ ,

$$|\mathbf{X}_i - \mathbf{Y}| \leq \frac{L\sqrt{m}}{N}.$$

This and (7.1.38) imply that

$$|\mathbf{G}(\mathbf{X}_i) - \mathbf{G}(\mathbf{Y})| \leq \frac{ML\sqrt{m}}{N},$$

which in turn implies that  $\mathbf{G}(\mathbf{Y})$  lies in a cube  $\tilde{R}_i$  in  $\mathbb{R}^n$  centered at  $\mathbf{G}(\mathbf{X}_i)$ , with sides of length  $2ML\sqrt{m}/N$ . Now

$$\sum_{i=1}^k V(\tilde{R}_i) = k \left( \frac{2ML\sqrt{m}}{N} \right)^n \leq N^m \left( \frac{2ML\sqrt{m}}{N} \right)^n = (2ML\sqrt{m})^n N^{m-n}.$$

Since  $n > m$ , we can make the sum on the left arbitrarily small by taking  $N$  sufficiently large. Therefore,  $S$  has zero content. ■

Theorems 7.1.19 and 7.1.21 imply the following theorem.

**Theorem 7.1.22** Suppose that  $S$  is a bounded set in  $\mathbb{R}^n$ , with boundary consisting of a finite number of differentiable surfaces. Let  $f$  be bounded on  $S$  and continuous except on a set of zero content. Then  $f$  is integrable on  $S$ .

**Example 7.1.10** Let

$$S = \{(x, y) \mid x^2 + y^2 = 1, x \geq 0\};$$

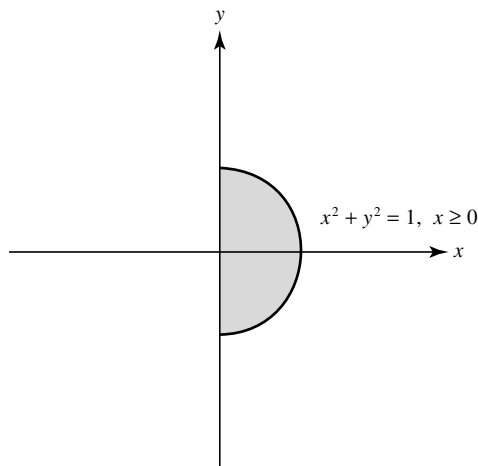
thus,  $S$  is bounded by a semicircle and a line segment (Figure 7.1.6), both differentiable curves in  $\mathbb{R}^2$ . Let

$$f(x, y) = \begin{cases} (1 - x^2 - y^2)^{1/2}, & (x, y) \in S, y \geq 0, \\ -(1 - x^2 - y^2)^{1/2}, & (x, y) \in S, y < 0. \end{cases}$$

Then  $f$  is continuous on  $S$  except on the line segment

$$y = 0, \quad 0 \leq x < 1,$$

which has zero content, from Example 7.1.5. Hence, Theorem 7.1.22 implies that  $f$  is integrable on  $S$ .



**Figure 7.1.6**

## Properties of Multiple Integrals

We now list some theorems on properties of multiple integrals. The proofs are similar to those of the analogous theorems in Section 3.3.

Note: Because of Definition 7.1.17, if we say that a function  $f$  is integrable on a set  $S$ , then  $S$  is necessarily bounded.



**Theorem 7.1.23** *If  $f$  and  $g$  are integrable on  $S$ , then so is  $f + g$ , and*

$$\int_S (f + g)(\mathbf{X}) d\mathbf{X} = \int_S f(\mathbf{X}) d\mathbf{X} + \int_S g(\mathbf{X}) d\mathbf{X}.$$

**Proof** Exercise 7.1.20.

**Theorem 7.1.24** *If  $f$  is integrable on  $S$  and  $c$  is a constant, then  $cf$  is integrable on  $S$ , and*

$$\int_S (cf)(\mathbf{X}) d\mathbf{X} = c \int_S f(\mathbf{X}) d\mathbf{X}.$$

**Proof** Exercise 7.1.21.

**Theorem 7.1.25** *If  $f$  and  $g$  are integrable on  $S$  and  $f(\mathbf{X}) \leq g(\mathbf{X})$  for  $\mathbf{X}$  in  $S$ , then*

$$\int_S f(\mathbf{X}) d\mathbf{X} \leq \int_S g(\mathbf{X}) d\mathbf{X}.$$

**Proof** Exercise 7.1.22.

**Theorem 7.1.26** *If  $f$  is integrable on  $S$ , then so is  $|f|$ , and*

$$\left| \int_S f(\mathbf{X}) d\mathbf{X} \right| \leq \int_S |f(\mathbf{X})| d\mathbf{X}.$$

**Proof** Exercise 7.1.23.

**Theorem 7.1.27** *If  $f$  and  $g$  are integrable on  $S$ , then so is the product  $fg$ .*

**Proof** Exercise 7.1.24.

**Theorem 7.1.28** *Suppose that  $u$  is continuous and  $v$  is integrable and nonnegative on a rectangle  $R$ . Then*

$$\int_R u(\mathbf{X})v(\mathbf{X}) d\mathbf{X} = u(\mathbf{X}_0) \int_R v(\mathbf{X}) d\mathbf{X}$$

for some  $\mathbf{X}_0$  in  $R$ .

**Proof** Exercise 7.1.25.

**Lemma 7.1.29** *Suppose that  $S$  is contained in a bounded set  $T$  and  $f$  is integrable on  $S$ . Then  $f_S$  (see (7.1.36)) is integrable on  $T$ , and*

$$\int_T f_S(\mathbf{X}) d\mathbf{X} = \int_S f(\mathbf{X}) d\mathbf{X}.$$

**Proof** From Definition 7.1.17 with  $f$  and  $S$  replaced by  $f_S$  and  $T$ ,

$$(f_S)_T(\mathbf{X}) = \begin{cases} f_S(\mathbf{X}), & \mathbf{X} \in T, \\ 0, & \mathbf{X} \notin T. \end{cases}$$

Since  $S \subset T$ ,  $(f_S)_T = f_S$ . (Verify.) Now suppose that  $R$  is a rectangle containing  $T$ . Then  $R$  also contains  $S$  (Figure 7.1.7),

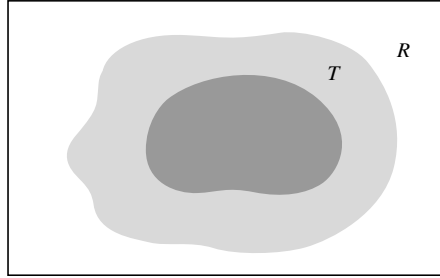


Figure 7.1.7

so

$$\begin{aligned} \int_S f(\mathbf{X}) d\mathbf{X} &= \int_R f_S(\mathbf{X}) d\mathbf{X} && \text{(Definition 7.1.17, applied to } f \text{ and } S) \\ &= \int_R (f_S)_T(\mathbf{X}) d\mathbf{X} && \text{(since } (f_S)_T = f_S) \\ &= \int_T f_S(\mathbf{X}) d\mathbf{X} && \text{(Definition 7.1.17, applied to } f_S \text{ and } T), \end{aligned}$$

which completes the proof. ■

**Theorem 7.1.30** *If  $f$  is integrable on disjoint sets  $S_1$  and  $S_2$ , then  $f$  is integrable on  $S_1 \cup S_2$ , and*

$$\int_{S_1 \cup S_2} f(\mathbf{X}) d\mathbf{X} = \int_{S_1} f(\mathbf{X}) d\mathbf{X} + \int_{S_2} f(\mathbf{X}) d\mathbf{X}. \quad (7.1.39)$$

**Proof** For  $i = 1, 2$ , let

$$f_{S_i}(\mathbf{X}) = \begin{cases} f(\mathbf{X}), & \mathbf{X} \in S_i, \\ 0, & \mathbf{X} \notin S_i. \end{cases}$$

From Lemma 7.1.29 with  $S = S_i$  and  $T = S_1 \cup S_2$ ,  $f_{S_i}$  is integrable on  $S_1 \cup S_2$ , and

$$\int_{S_1 \cup S_2} f_{S_i}(\mathbf{X}) d\mathbf{X} = \int_{S_i} f(\mathbf{X}) d\mathbf{X}, \quad i = 1, 2.$$

Theorem 7.1.23 now implies that  $f_{S_1} + f_{S_2}$  is integrable on  $S_1 \cup S_2$  and

$$\int_{S_1 \cup S_2} (f_{S_1} + f_{S_2})(\mathbf{X}) d\mathbf{X} = \int_{S_1} f(\mathbf{X}) d\mathbf{X} + \int_{S_2} f(\mathbf{X}) d\mathbf{X}. \quad (7.1.40)$$

Since  $S_1 \cap S_2 = \emptyset$ ,

$$(f_{S_1} + f_{S_2})(\mathbf{X}) = f_{S_1}(\mathbf{X}) + f_{S_2}(\mathbf{X}) = f(\mathbf{X}), \quad \mathbf{X} \in S_1 \cup S_2.$$

Therefore, (7.1.40) implies (7.1.39).  $\blacksquare$

We leave it to you to prove the following extension of Theorem 7.1.30. (Exercise 7.1.31(b)).

**Corollary 7.1.31** *Suppose that  $f$  is integrable on sets  $S_1$  and  $S_2$  such that  $S_1 \cap S_2$  has zero content. Then  $f$  is integrable on  $S_1 \cup S_2$ , and*

$$\int_{S_1 \cup S_2} f(\mathbf{X}) d\mathbf{X} = \int_{S_1} f(\mathbf{X}) d\mathbf{X} + \int_{S_2} f(\mathbf{X}) d\mathbf{X}.$$

**Example 7.1.11** Let

$$S_1 = \{(x, y) \mid 0 \leq x \leq 1, 0 \leq y \leq 1 + x\}$$

and

$$S_2 = \{(x, y) \mid -1 \leq x \leq 0, 0 \leq y \leq 1 - x\}$$

(Figure 7.1.8).

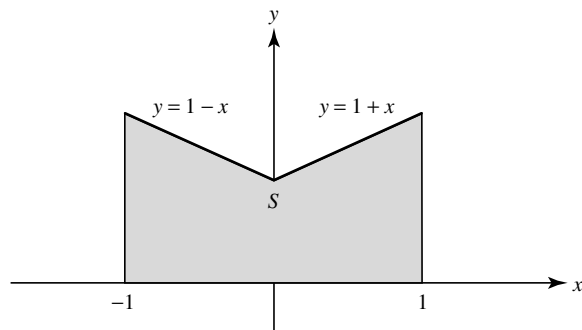


Figure 7.1.8

Then

$$S_1 \cap S_2 = \{(0, y) \mid 0 \leq y \leq 1\}$$

has zero content. Hence, Corollary 7.1.31 implies that if  $f$  is integrable on  $S_1$  and  $S_2$ , then  $f$  is also integrable over

$$S = S_1 \cup S_2 = \{(x, y) \mid -1 \leq x \leq 1, 0 \leq y \leq 1 + |x|\}$$

(Figure 7.1.9), and

$$\int_{S_1 \cup S_2} f(\mathbf{X}) d\mathbf{X} = \int_{S_1} f(\mathbf{X}) d\mathbf{X} + \int_{S_2} f(\mathbf{X}) d\mathbf{X}.$$

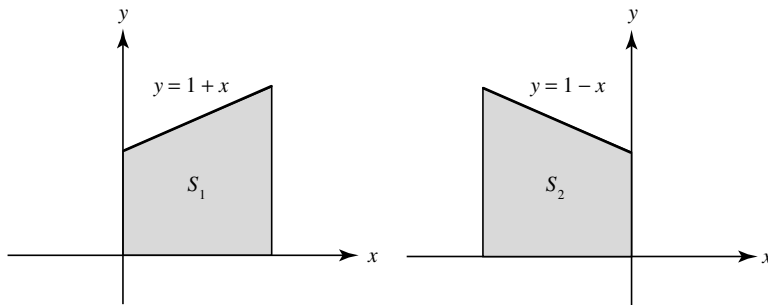


Figure 7.1.9

We will discuss this example further in the next section.

### 7.1 Exercises

1. Prove: If  $R$  is degenerate, then Definition 7.1.2 implies that  $\int_R f(\mathbf{X}) d\mathbf{X} = 0$  if  $f$  is bounded on  $R$ .
2. Evaluate directly from Definition 7.1.2.
  - (a)  $\int_R (3x + 2y) d(x, y)$ ;  $R = [0, 2] \times [1, 3]$
  - (b)  $\int_R xy d(x, y)$ ;  $R = [0, 1] \times [0, 1]$
3. Suppose that  $\int_a^b f(x) dx$  and  $\int_c^d g(y) dy$  exist, and let  $R = [a, b] \times [c, d]$ . Criticize the following “proof” that  $\int_R f(x)g(y) d(x, y)$  exists and equals

$$\left( \int_a^b f(x) dx \right) \left( \int_c^d g(y) dy \right).$$

(See Exercise 7.1.30 for a correct proof of this assertion.)

“Proof.” Let

$$P_1 : a = x_0 < x_1 < \cdots < x_r = b \quad \text{and} \quad P_2 : c = y_0 < y_1 < \cdots < y_s = d$$

be partitions of  $[a, b]$  and  $[c, d]$ , and  $P = P_1 \times P_2$ . Then a typical Riemann sum of  $fg$  over  $P$  is of the form

$$\sigma = \sum_{i=1}^r \sum_{j=1}^s f(\xi_i)g(\eta_j)(x_i - x_{i-1})(y_j - y_{j-1}) = \sigma_1\sigma_2,$$

where

$$\sigma_1 = \sum_{i=1}^r f(\xi_i)(x_i - x_{i-1}) \quad \text{and} \quad \sigma_2 = \sum_{j=1}^s g(\eta_j)(y_j - y_{j-1})$$

are typical Riemann sums of  $f$  over  $[a, b]$  and  $g$  over  $[c, d]$ . Since  $f$  and  $g$  are integrable on these intervals,

$$\left| \sigma_1 - \int_a^b f(x) dx \right| \quad \text{and} \quad \left| \sigma_2 - \int_c^d g(y) dy \right|$$

can be made arbitrarily small by taking  $\|P_1\|$  and  $\|P_2\|$  sufficiently small. From this, it is straightforward to show that

$$\left| \sigma - \left( \int_a^b f(x) dx \right) \left( \int_c^d g(y) dy \right) \right|$$

can be made arbitrarily small by taking  $\|P\|$  sufficiently small. This implies the stated result.

4. Suppose that  $f(x, y) \geq 0$  on  $R = [a, b] \times [c, d]$ . Justify the interpretation of  $\int_R f(x, y) d(x, y)$ , if it exists, as the volume of the region in  $\mathbb{R}^3$  bounded by the surfaces  $z = f(x, y)$  and the planes  $z = 0$ ,  $x = a$ ,  $x = b$ ,  $y = c$ , and  $y = d$ .
5. Prove Theorem 7.1.5. HINT: See the proof of Theorem 3.1.4.
6. Suppose that

$$f(x, y) = \begin{cases} 0 & \text{if } x \text{ and } y \text{ are rational,} \\ 1 & \text{if } x \text{ is rational and } y \text{ is irrational,} \\ 2 & \text{if } x \text{ is irrational and } y \text{ is rational,} \\ 3 & \text{if } x \text{ and } y \text{ are irrational.} \end{cases}$$

Find

$$\overline{\int_R f(x, y) d(x, y)} \quad \text{and} \quad \underline{\int_R f(x, y) d(x, y)} \quad \text{if } R = [a, b] \times [c, d].$$

7. Prove Eqn. (7.1.17) of Lemma 7.1.6.
8. Prove Theorem 7.1.7 HINT: See the proof of Theorem 3.2.2.
9. Prove Theorem 7.1.8 HINT: See the proof of Theorem 3.2.3.
10. Prove Lemma 7.1.9 HINT: See the proof of Lemma 3.2.4.
11. Prove Theorem 7.1.10 HINT: See the proof of Theorem 3.2.5.
12. Prove Theorem 7.1.12 HINT: See the proof of Theorem 3.2.7.
13. Give an example of a denumerable set in  $\mathbb{R}^2$  that does not have zero content.
14. Prove:
  - (a) If  $S_1$  and  $S_2$  have zero content, then  $S_1 \cup S_2$  has zero content.
  - (b) If  $S_1$  has zero content and  $S_2 \subset S_1$ , then  $S_2$  has zero content.
  - (c) If  $S$  has zero content, then  $\overline{S}$  has zero content.
15. Show that a degenerate rectangle has zero content.

16. Suppose that  $f$  is continuous on a compact set  $S$  in  $\mathbb{R}^n$ . Show that the surface  $z = f(\mathbf{X})$ ,  $\mathbf{X} \in S$ , has zero content in  $\mathbb{R}^{n+1}$ . HINT: See Example 7.1.5.
17. Let  $S$  be a bounded set such that  $S \cap \partial S$  does not have zero content.
- Suppose that  $f$  is defined on  $S$  and  $f(\mathbf{X}) \geq \rho > 0$  on a subset  $T$  of  $S \cap \partial S$  that does not have zero content. Show that  $f$  is not integrable on  $S$ .
  - Conclude that  $V(S)$  is undefined.
18. (a) Suppose that  $h$  is bounded and  $h(\mathbf{X}) = 0$  except on a set of zero content. Show that  $\int_S h(\mathbf{X}) d\mathbf{X} = 0$  for any bounded set  $S$ .
- (b) Suppose that  $\int_S f(\mathbf{X}) d\mathbf{X}$  exists,  $g$  is bounded on  $S$ , and  $f(\mathbf{X}) = g(\mathbf{X})$  except for  $\mathbf{X}$  in a set of zero content. Show that  $g$  is integrable on  $S$  and

$$\int_S g(\mathbf{X}) d\mathbf{X} = \int_S f(\mathbf{X}) d\mathbf{X}.$$

19. Suppose that  $f$  is integrable on a set  $S$  and  $S_0$  is a subset of  $S$  such that  $\partial S_0$  has zero content. Show that  $f$  is integrable on  $S_0$ .
20. Prove Theorem 7.1.23 HINT: See the proof of Theorem 3.3.1.
21. Prove Theorem 7.1.24.
22. Prove Theorem 7.1.25 HINT: See the proof of Theorem 3.3.4.
23. Prove Theorem 7.1.26 HINT: See the proof of Theorem 3.3.5.
24. Prove Theorem 7.1.27 HINT: See the proof of Theorem 3.3.6.
25. Prove Theorem 7.1.28 HINT: See the proof of Theorem 3.3.7.
26. Prove: If  $f$  is integrable on a rectangle  $R$ , then  $f$  is integrable on any subrectangle of  $R$ . HINT: Use Theorem 7.1.12; see the proof of Theorem 3.3.8.
27. Suppose that  $R$  and  $\tilde{R}$  are rectangles,  $R \subset \tilde{R}$ ,  $g$  is bounded on  $\tilde{R}$ , and  $g(\mathbf{X}) = 0$  if  $\mathbf{X} \notin R$ .
- (a) Show that  $\int_{\tilde{R}} g(\mathbf{X}) d\mathbf{X}$  exists if and only if  $\int_R g(\mathbf{X}) d\mathbf{X}$  exists and, in this case,

$$\int_{\tilde{R}} g(\mathbf{X}) d\mathbf{X} = \int_R g(\mathbf{X}) d\mathbf{X}.$$

HINT: Use Exercise 7.1.26.

- (b) Use (a) to show that Definition 7.1.17 is legitimate; that is, the existence and value of  $\int_S f(\mathbf{X}) d\mathbf{X}$  does not depend on the particular rectangle chosen to contain  $S$ .
28. (a) Suppose that  $f$  is integrable on a rectangle  $R$  and  $P = \{R_1, R_2, \dots, R_k\}$  is a partition of  $R$ . Show that

$$\int_R f(\mathbf{X}) d\mathbf{X} = \sum_{j=1}^k \int_{R_j} f(\mathbf{X}) d\mathbf{X}.$$

HINT: Use Exercise 7.1.26.

- (b) Use (a) to show that if  $f$  is continuous on  $R$  and  $P$  is a partition of  $R$ , then there is a Riemann sum of  $f$  over  $P$  that equals  $\int_R f(\mathbf{X}) d\mathbf{X}$ .
29. Suppose that  $f$  is continuously differentiable on a rectangle  $R$ . Show that there is a constant  $M$  such that

$$\left| \sigma - \int_R f(\mathbf{X}) d\mathbf{X} \right| \leq M \|P\|$$

if  $\sigma$  is any Riemann sum of  $f$  over a partition  $P$  of  $R$ . HINT: Use Exercise 7.1.28(b) and Theorem 5.4.5.

30. Suppose that  $\int_a^b f(x) dx$  and  $\int_c^d g(y) dy$  exist, and let  $R = [a, b] \times [c, d]$ .
- (a) Use Theorems 3.2.7 and 7.1.12 to show that

$$\int_R f(x) d(x, y) \quad \text{and} \quad \int_R g(y) d(x, y)$$

both exist.

- (b) Use Theorem 7.1.27 to prove that  $\int_R f(x)g(y) d(x, y)$  exists.
- (c) Justify using the argument given in Exercise 7.1.3 to show that

$$\int_R f(x)g(y) d(x, y) = \left( \int_a^b f(x) dx \right) \left( \int_c^d g(y) dy \right).$$

31. (a) Suppose that  $f$  is integrable on  $S$  and  $S_0$  is obtained by removing a set of zero content from  $S$ . Show that  $f$  is integrable on  $S_0$  and  $\int_{S_0} f(\mathbf{X}) d\mathbf{X} = \int_S f(\mathbf{X}) d\mathbf{X}$ .
- (b) Prove Corollary 7.1.31.

## 7.2 ITERATED INTEGRALS AND MULTIPLE INTEGRALS

Except for very simple examples, it is impractical to evaluate multiple integrals directly from Definitions 7.1.2 and 7.1.17. Fortunately, this can usually be accomplished by evaluating  $n$  successive ordinary integrals. To motivate the method, let us first assume that  $f$  is continuous on  $R = [a, b] \times [c, d]$ . Then, for each  $y$  in  $[c, d]$ ,  $f(x, y)$  is continuous with respect to  $x$  on  $[a, b]$ , so the integral

$$F(y) = \int_a^b f(x, y) dx$$

exists. Moreover, the uniform continuity of  $f$  on  $R$  implies that  $F$  is continuous (Exercise 7.2.3) and therefore integrable on  $[c, d]$ . We say that

$$I_1 = \int_c^d F(y) dy = \int_c^d \left( \int_a^b f(x, y) dx \right) dy$$

is an *iterated integral* of  $f$  over  $R$ . We will usually write it as

$$I_1 = \int_c^d dy \int_a^b f(x, y) dx.$$

Another iterated integral can be defined by writing

$$G(x) = \int_c^d f(x, y) dy, \quad a \leq x \leq b,$$

and defining

$$I_2 = \int_a^b G(x) dx = \int_a^b \left( \int_c^d f(x, y) dy \right) dx,$$

which we usually write as

$$I_2 = \int_a^b dx \int_c^d f(x, y) dy.$$

**Example 7.2.1** Let

$$f(x, y) = x + y$$

and  $R = [0, 1] \times [1, 2]$ . Then

$$F(y) = \int_0^1 f(x, y) dx = \int_0^1 (x + y) dx = \left( \frac{x^2}{2} + xy \right) \Big|_{x=0}^1 = \frac{1}{2} + y$$

and

$$I_1 = \int_1^2 F(y) dy = \int_1^2 \left( \frac{1}{2} + y \right) dy = \left( \frac{y}{2} + \frac{y^2}{2} \right) \Big|_1^2 = 2.$$

Also,

$$G(x) = \int_1^2 (x + y) dy = \left( xy + \frac{y^2}{2} \right) \Big|_{y=1}^2 = (2x + 2) - \left( x + \frac{1}{2} \right) = x + \frac{3}{2},$$

and

$$I_2 = \int_0^1 G(x) dx = \int_0^1 \left( x + \frac{3}{2} \right) dx = \left( \frac{x^2}{2} + \frac{3x}{2} \right) \Big|_0^1 = 2.$$

In this example,  $I_1 = I_2$ ; moreover, on setting  $a = 0$ ,  $b = 1$ ,  $c = 1$ , and  $d = 2$  in Example 7.1.1, we see that

$$\int_R (x + y) d(x, y) = 2,$$

so the common value of the iterated integrals equals the multiple integral. The following theorem shows that this is not an accident.



**Theorem 7.2.1** Suppose that  $f$  is integrable on  $R = [a, b] \times [c, d]$  and

$$F(y) = \int_a^b f(x, y) dx$$

exists for each  $y$  in  $[c, d]$ . Then  $F$  is integrable on  $[c, d]$ , and

$$\int_c^d F(y) dy = \int_R f(x, y) d(x, y); \quad (7.2.1)$$

that is,

$$\int_c^d dy \int_a^b f(x, y) dx = \int_R f(x, y) d(x, y). \quad (7.2.2)$$

**Proof** Let

$$P_1 : a = x_0 < x_1 < \cdots < x_r = b \quad \text{and} \quad P_2 : c = y_0 < y_1 < \cdots < y_s = d$$

be partitions of  $[a, b]$  and  $[c, d]$ , and  $\mathbf{P} = P_1 \times P_2$ . Suppose that

$$y_{j-1} \leq \eta_j \leq y_j, \quad 1 \leq j \leq s, \quad (7.2.3)$$

so

$$\sigma = \sum_{j=1}^s F(\eta_j)(y_j - y_{j-1}) \quad (7.2.4)$$

is a typical Riemann sum of  $F$  over  $P_2$ . Since

$$F(\eta_j) = \int_a^b f(x, \eta_j) dx = \sum_{i=1}^r \int_{x_{i-1}}^{x_i} f(x, \eta_j) dx,$$

(7.2.3) implies that if

$$m_{ij} = \inf \{ f(x, y) \mid x_{i-1} \leq x \leq x_i, y_{j-1} \leq y \leq y_j \}$$

and

$$M_{ij} = \sup \{ f(x, y) \mid x_{i-1} \leq x \leq x_i, y_{j-1} \leq y \leq y_j \},$$

then

$$\sum_{i=1}^r m_{ij}(x_i - x_{i-1}) \leq F(\eta_j) \leq \sum_{i=1}^r M_{ij}(x_i - x_{i-1}).$$

Multiplying this by  $y_j - y_{j-1}$  and summing from  $j = 1$  to  $j = s$  yields

$$\begin{aligned} \sum_{j=1}^s \sum_{i=1}^r m_{ij}(x_i - x_{i-1})(y_j - y_{j-1}) &\leq \sum_{j=1}^s F(\eta_j)(y_j - y_{j-1}) \\ &\leq \sum_{j=1}^s \sum_{i=1}^r M_{ij}(x_i - x_{i-1})(y_j - y_{j-1}), \end{aligned}$$

which, from (7.2.4), can be rewritten as

$$s_f(\mathbf{P}) \leq \sigma \leq S_f(\mathbf{P}), \quad (7.2.5)$$

where  $s_f(\mathbf{P})$  and  $S_f(\mathbf{P})$  are the lower and upper sums of  $f$  over  $\mathbf{P}$ . Now let  $s_F(P_2)$  and  $S_F(P_2)$  be the lower and upper sums of  $F$  over  $P_2$ ; since they are respectively the infimum and supremum of the Riemann sums of  $F$  over  $P_2$  (Theorem 3.1.4), (7.2.5) implies that

$$s_f(\mathbf{P}) \leq s_F(P_2) \leq S_F(P_2) \leq S_f(\mathbf{P}). \quad (7.2.6)$$

Since  $f$  is integrable on  $R$ , there is for each  $\epsilon > 0$  a partition  $\mathbf{P}$  of  $R$  such that  $S_f(\mathbf{P}) - s_f(\mathbf{P}) < \epsilon$ , from Theorem 7.1.12. Consequently, from (7.2.6), there is a partition  $P_2$  of  $[c, d]$  such that  $S_F(P_2) - s_F(P_2) < \epsilon$ , so  $F$  is integrable on  $[c, d]$ , from Theorem 3.2.7.

It remains to verify (7.2.1). From (7.2.4) and the definition of  $\int_c^d F(y) dy$ , there is for each  $\epsilon > 0$  a  $\delta > 0$  such that

$$\left| \int_c^d F(y) dy - \sigma \right| < \epsilon \quad \text{if} \quad \|P_2\| < \delta;$$

that is,

$$\sigma - \epsilon < \int_c^d F(y) dy < \sigma + \epsilon \quad \text{if} \quad \|P_2\| < \delta.$$

This and (7.2.5) imply that

$$s_f(\mathbf{P}) - \epsilon < \int_c^d F(y) dy < S_f(\mathbf{P}) + \epsilon \quad \text{if} \quad \|\mathbf{P}\| < \delta,$$

and this implies that

$$\int_{\underline{R}} f(x, y) d(x, y) - \epsilon \leq \int_c^d F(y) dy \leq \overline{\int}_R f(x, y) d(x, y) + \epsilon \quad (7.2.7)$$

(Definition 7.1.4). Since

$$\int_{\underline{R}} f(x, y) d(x, y) = \overline{\int}_R f(x, y) d(x, y)$$

(Theorem 7.1.8) and  $\epsilon$  can be made arbitrarily small, (7.2.7) implies (7.2.1). ■

If  $f$  is continuous on  $R$ , then  $f$  satisfies the hypotheses of Theorem 7.2.1 (Exercise 7.2.3), so (7.2.2) is valid in this case.

If  $\int_R f(x, y) d(x, y)$  and

$$\int_c^d f(x, y) dy, \quad a \leq x \leq b,$$

exist, then by interchanging  $x$  and  $y$  in Theorem 7.2.1, we see that

$$\int_a^b dx \int_c^d f(x, y) dy = \int_R f(x, y) d(x, y).$$

This and (7.2.2) yield the following corollary of Theorem 7.2.1.

**Corollary 7.2.2** *If  $f$  is integrable on  $[a, b] \times [c, d]$ , then*

$$\int_a^b dx \int_c^d f(x, y) dy = \int_c^d dy \int_a^b f(x, y) dx,$$

*provided that  $\int_c^d f(x, y) dy$  exists for  $a \leq x \leq b$  and  $\int_a^b f(x, y) dx$  exists for  $c \leq y \leq d$ . In particular, these hypotheses hold if  $f$  is continuous on  $[a, b] \times [c, d]$ .*

**Example 7.2.2** The function

$$f(x, y) = x + y$$

is continuous everywhere, so (7.2.2) holds for every rectangle  $R$ . For example, let  $R = [0, 1] \times [1, 2]$ . Then (7.2.2) yields

$$\begin{aligned} \int_R (x + y) d(x, y) &= \int_1^2 dy \int_0^1 (x + y) dx = \int_1^2 \left[ \left( \frac{x^2}{2} + xy \right) \Big|_{x=0}^1 \right] dy \\ &= \int_1^2 \left( \frac{1}{2} + y \right) dy = \left( \frac{y}{2} + \frac{y^2}{2} \right) \Big|_1^2 = 2. \end{aligned}$$

Since  $f$  also satisfies the hypotheses of Theorem 7.2.1 with  $x$  and  $y$  interchanged, we can calculate the double integral from the iterated integral in which the integrations are performed in the opposite order; thus,

$$\begin{aligned} \int_R (x + y) d(x, y) &= \int_0^1 dx \int_1^2 (x + y) dy = \int_0^1 \left[ \left( xy + \frac{y^2}{2} \right) \Big|_{y=1}^2 \right] dx \\ &= \int_0^1 \left( x + \frac{3}{2} \right) dx = \left( \frac{x^2}{2} + \frac{3x}{2} \right) \Big|_0^1 = 2. \end{aligned}$$

■

A plausible partial converse of Theorem 7.2.1 would be that if  $\int_c^d dy \int_a^b f(x, y) dx$  exists then so does  $\int_R f(x, y) d(x, y)$ ; however, the next example shows that this need not be so.

**Example 7.2.3** If  $f$  is defined on  $R = [0, 1] \times [0, 1]$  by

$$f(x, y) = \begin{cases} 2xy & \text{if } y \text{ is rational,} \\ y & \text{if } y \text{ is irrational,} \end{cases}$$

then

$$\int_0^1 f(x, y) dx = y, \quad 0 \leq y \leq 1,$$

and

$$\int_0^1 dy \int_0^1 f(x, y) dx = \int_0^1 y dy = \frac{1}{2}.$$

However,  $f$  is not integrable on  $R$  (Exercise 7.2.7). ■

The next theorem generalizes Theorem 7.2.1 to  $\mathbb{R}^n$ .

**Theorem 7.2.3** Let  $I_1, I_2, \dots, I_n$  be closed intervals and suppose that  $f$  is integrable on  $R = I_1 \times I_2 \times \dots \times I_n$ . Suppose that there is an integer  $p$  in  $\{1, 2, \dots, n-1\}$  such that

$$F_p(x_{p+1}, x_{p+2}, \dots, x_n) = \int_{I_1 \times I_2 \times \dots \times I_p} f(x_1, x_2, \dots, x_n) d(x_1, x_2, \dots, x_p)$$

exists for each  $(x_{p+1}, x_{p+2}, \dots, x_n)$  in  $I_{p+1} \times I_{p+2} \times \dots \times I_n$ . Then

$$\int_{I_{p+1} \times I_{p+2} \times \dots \times I_n} F_p(x_{p+1}, x_{p+2}, \dots, x_n) d(x_{p+1}, x_{p+2}, \dots, x_n)$$

exists and equals  $\int_R f(\mathbf{X}) d\mathbf{X}$ .

**Proof** For convenience, denote  $(x_{p+1}, x_{p+2}, \dots, x_n)$  by  $\mathbf{Y}$ . Denote  $\widehat{R} = I_1 \times I_2 \times \dots \times I_p$  and  $T = I_{p+1} \times I_{p+2} \times \dots \times I_n$ . Let  $\widehat{\mathbf{P}} = \{\widehat{R}_1, \widehat{R}_2, \dots, \widehat{R}_k\}$  and  $\mathbf{Q} = \{T_1, T_2, \dots, T_s\}$  be partitions of  $\widehat{R}$  and  $T$ , respectively. Then the collection of rectangles of the form  $\widehat{R}_i \times T_j$  ( $1 \leq i \leq k$ ,  $1 \leq j \leq s$ ) is a partition  $\mathbf{P}$  of  $R$ ; moreover, every partition  $\mathbf{P}$  of  $R$  is of this form.

Suppose that

$$\mathbf{Y}_j \in T_j, \quad 1 \leq j \leq s, \quad (7.2.8)$$

so

$$\sigma = \sum_{j=1}^s F_p(\mathbf{Y}_j) V(T_j) \quad (7.2.9)$$

is a typical Riemann sum of  $F_p$  over  $\mathbf{Q}$ . Since

$$\begin{aligned} F_p(\mathbf{Y}_j) &= \int_{\widehat{R}} f(x_1, x_2, \dots, x_p, \mathbf{Y}_j) d(x_1, x_2, \dots, x_p) \\ &= \sum_{i=1}^k \int_{\widehat{R}_i} f(x_1, x_2, \dots, x_p, \mathbf{Y}_j) d(x_1, x_2, \dots, x_p), \end{aligned}$$

(7.2.8) implies that if

$$m_{ij} = \inf \left\{ f(x_1, x_2, \dots, x_p, \mathbf{Y}) \mid (x_1, x_2, \dots, x_p) \in \widehat{R}_i, \mathbf{Y} \in T_j \right\}$$

and

$$M_{ij} = \sup \left\{ f(x_1, x_2, \dots, x_p, \mathbf{Y}) \mid (x_1, x_2, \dots, x_p) \in \widehat{R}_i, \mathbf{Y} \in T_j \right\},$$

then

$$\sum_{i=1}^k m_{ij} V(\widehat{R}_i) \leq F_p(\mathbf{Y}_j) \leq \sum_{i=1}^k M_{ij} V(\widehat{R}_i).$$

Multiplying this by  $V(T_j)$  and summing from  $j = 1$  to  $j = s$  yields

$$\sum_{j=1}^s \sum_{i=1}^k m_{ij} V(\widehat{R}_i) V(T_j) \leq \sum_{j=1}^s F_p(\mathbf{Y}_j) V(T_j) \leq \sum_{j=1}^s \sum_{i=1}^k M_{ij} V(\widehat{R}_i) V(T_j),$$

which, from (7.2.9), can be rewritten as

$$s_f(\mathbf{P}) \leq \sigma \leq S_f(\mathbf{P}), \quad (7.2.10)$$

where  $s_f(\mathbf{P})$  and  $S_f(\mathbf{P})$  are the lower and upper sums of  $f$  over  $\mathbf{P}$ . Now let  $s_{F_p}(\mathbf{Q})$  and  $S_{F_p}(\mathbf{Q})$  be the lower and upper sums of  $F_p$  over  $\mathbf{Q}$ ; since they are respectively the infimum and supremum of the Riemann sums of  $F_p$  over  $\mathbf{Q}$  (Theorem 7.1.5), (7.2.10) implies that

$$s_f(\mathbf{P}) \leq s_{F_p}(\mathbf{Q}) \leq S_{F_p}(\mathbf{Q}) \leq S_f(\mathbf{P}). \quad (7.2.11)$$

Since  $f$  is integrable on  $R$ , there is for each  $\epsilon > 0$  a partition  $\mathbf{P}$  of  $R$  such that  $S_f(\mathbf{P}) - s_f(\mathbf{P}) < \epsilon$ , from Theorem 7.1.12. Consequently, from (7.2.11), there is a partition  $\mathbf{Q}$  of  $T$  such that  $S_{F_p}(\mathbf{Q}) - s_{F_p}(\mathbf{Q}) < \epsilon$ , so  $F_p$  is integrable on  $T$ , from Theorem 7.1.12.

It remains to verify that

$$\int_R f(\mathbf{X}) d\mathbf{X} = \int_T F_p(\mathbf{Y}) d\mathbf{Y}. \quad (7.2.12)$$

From (7.2.9) and the definition of  $\int_T F_p(\mathbf{Y}) d\mathbf{Y}$ , there is for each  $\epsilon > 0$  a  $\delta > 0$  such that

$$\left| \int_T F_p(\mathbf{Y}) d\mathbf{Y} - \sigma \right| < \epsilon \quad \text{if} \quad \|\mathbf{Q}\| < \delta;$$

that is,

$$\sigma - \epsilon < \int_T F_p(\mathbf{Y}) d\mathbf{Y} < \sigma + \epsilon \quad \text{if} \quad \|\mathbf{Q}\| < \delta.$$

This and (7.2.10) imply that

$$s_f(\mathbf{P}) - \epsilon < \int_T F_p(\mathbf{Y}) d\mathbf{Y} < S_f(\mathbf{P}) + \epsilon \quad \text{if} \quad \|\mathbf{P}\| < \delta,$$

and this implies that

$$\underline{\int_R} f(\mathbf{X}) d\mathbf{X} - \epsilon \leq \int_T F_p(\mathbf{Y}) d\mathbf{Y} \leq \overline{\int_R} f(\mathbf{X}) d\mathbf{X} + \epsilon. \quad (7.2.13)$$

Since  $\underline{\int_R} f(\mathbf{X}) d\mathbf{X} = \overline{\int_R} f(\mathbf{X}) d\mathbf{X}$  (Theorem 7.1.8) and  $\epsilon$  can be made arbitrarily small, (7.2.13) implies (7.2.12). ■

**Theorem 7.2.4** Let  $I_j = [a_j, b_j]$ ,  $1 \leq j \leq n$ , and suppose that  $f$  is integrable on  $R = I_1 \times I_2 \times \cdots \times I_n$ . Suppose also that the integrals

$$F_p(x_{p+1}, \dots, x_n) = \int_{I_1 \times I_2 \times \cdots \times I_p} f(\mathbf{X}) d(x_1, x_2, \dots, x_p), \quad 1 \leq p \leq n-1,$$

exist for all

$$(x_{p+1}, \dots, x_n) \text{ in } I_{p+1} \times \cdots \times I_n.$$

Then the iterated integral

$$\int_{a_n}^{b_n} dx_n \int_{a_{n-1}}^{b_{n-1}} dx_{n-1} \cdots \int_{a_2}^{b_2} dx_2 \int_{a_1}^{b_1} f(\mathbf{X}) dx_1$$

exists and equals  $\int_R f(\mathbf{X}) d\mathbf{X}$ .

**Proof** The proof is by induction. From Theorem 7.2.1, the proposition is true for  $n = 2$ . Now assume  $n > 2$  and the proposition is true with  $n$  replaced by  $n - 1$ . Holding  $x_n$  fixed and applying this assumption yields

$$F_n(x_n) = \int_{a_{n-1}}^{b_{n-1}} dx_{n-1} \int_{a_{n-2}}^{b_{n-2}} dx_{n-2} \cdots \int_{a_2}^{b_2} dx_2 \int_{a_1}^{b_1} f(\mathbf{X}) dx_1.$$

Now Theorem 7.2.3 with  $p = n - 1$  completes the induction. ■

**Example 7.2.4** Let  $R = [0, 1] \times [1, 2] \times [0, 1]$  and

$$f(x, y, z) = x + y + z.$$

Then

$$F_1(y, z) = \int_0^1 (x + y + z) dx = \left( \frac{x^2}{2} + xy + xz \right) \Big|_{x=0}^1 = \frac{1}{2} + y + z,$$

$$F_2(z) = \int_1^2 F_1(y, z) dy = \int_1^2 \left( \frac{1}{2} + y + z \right) dy$$

$$= \left( \frac{y}{2} + \frac{y^2}{2} + yz \right) \Big|_{y=1}^2 = 2 + z,$$

and

$$\int_R f(x, y, z) d(x, y, z) = \int_0^1 F_2(z) dz = \int_0^1 (2 + z) dz = \left( 2z + \frac{z^2}{2} \right) \Big|_0^1 = \frac{5}{2}. \quad \blacksquare$$

The hypotheses of Theorems 7.2.3 and 7.2.4 are stated so as to justify successive integrations with respect to  $x_1$ , then  $x_2$ , then  $x_3$ , and so forth. It is legitimate to use other orders of integration if the hypotheses are adjusted accordingly. For example, suppose that

$\{i_1, i_2, \dots, i_n\}$  is a permutation of  $\{1, 2, \dots, n\}$  and  $\int_R f(\mathbf{X}) d\mathbf{X}$  exists, along with

$$\int_{I_{i_1} \times I_{i_2} \times \dots \times I_{i_j}} f(\mathbf{X}) d(x_{i_1}, x_{i_2}, \dots, x_{i_j}), \quad 1 \leq j \leq n-1, \quad (7.2.14)$$

for each

$$(x_{i_{j+1}}, x_{i_{j+2}}, \dots, x_{i_n}) \quad \text{in} \quad I_{i_{j+1}} \times I_{i_{j+2}} \times \dots \times I_{i_n}. \quad (7.2.15)$$

Then, by renaming the variables, we infer from Theorem 7.2.4 that

$$\int_R f(\mathbf{X}) d\mathbf{X} = \int_{a_{i_n}}^{b_{i_n}} dx_{i_n} \int_{a_{i_{n-1}}}^{b_{i_{n-1}}} dx_{i_{n-1}} \cdots \int_{a_{i_2}}^{b_{i_2}} dx_{i_2} \int_{a_{i_1}}^{b_{i_1}} f(\mathbf{X}) dx_{i_1}. \quad (7.2.16)$$

Since there are  $n!$  permutations of  $\{1, 2, \dots, n\}$ , there are  $n!$  ways of evaluating a multiple integral over a rectangle in  $\mathbb{R}^n$ , provided that the integrand satisfies appropriate hypotheses. In particular, if  $f$  is continuous on  $R$  and  $\{i_1, i_2, \dots, i_n\}$  is any permutation of  $\{1, 2, \dots, n\}$ , then  $f$  is continuous with respect to  $(x_{i_1}, x_{i_2}, \dots, x_{i_j})$  on  $I_{i_1} \times I_{i_2} \times \dots \times I_{i_j}$  for each fixed  $(x_{i_{j+1}}, x_{i_{j+2}}, \dots, x_{i_n})$  satisfying (7.2.15). Therefore, the integrals (7.2.14) exist for every permutation of  $\{1, 2, \dots, n\}$  (Theorem 7.1.13). We summarize this in the next theorem, which now follows from Theorem 7.2.4.

**Theorem 7.2.5** *If  $f$  is continuous on*

$$R = [a_1, b_1] \times [a_2, b_2] \times \dots \times [a_n, b_n],$$

*then  $\int_R f(\mathbf{X}) d\mathbf{X}$  can be evaluated by iterated integrals in any of the  $n!$  ways indicated in (7.2.16).*

**Example 7.2.5** If  $f$  is continuous on  $R = [a_1, b_1] \times [a_2, b_2] \times [a_3, b_3]$ , then

$$\begin{aligned} \int_R f(x, y, z) d(x, y, z) &= \int_{a_3}^{b_3} dz \int_{a_2}^{b_2} dy \int_{a_1}^{b_1} f(x, y, z) dx \\ &= \int_{a_2}^{b_2} dy \int_{a_3}^{b_3} dz \int_{a_1}^{b_1} f(x, y, z) dx \\ &= \int_{a_3}^{b_3} dz \int_{a_1}^{b_1} dx \int_{a_2}^{b_2} f(x, y, z) dy \\ &= \int_{a_1}^{b_1} dx \int_{a_3}^{b_3} dz \int_{a_2}^{b_2} f(x, y, z) dy \\ &= \int_{a_2}^{b_2} dy \int_{a_1}^{b_1} dx \int_{a_3}^{b_3} f(x, y, z) dz \\ &= \int_{a_1}^{b_1} dx \int_{a_2}^{b_2} dy \int_{a_3}^{b_3} f(x, y, z) dz. \end{aligned}$$

### Integrals over More General Sets

We now consider the problem of evaluating multiple integrals over more general sets. First, suppose that  $f$  is integrable on a set of the form

$$S = \{(x, y) \mid u(y) \leq x \leq v(y), c \leq y \leq d\} \quad (7.2.17)$$

(Figure 7.2.1).

If  $u(y) \geq a$  and  $v(y) \leq b$  for  $c \leq y \leq d$ , and

$$f_S(x, y) = \begin{cases} f(x, y), & (x, y) \in S, \\ 0, & (x, y) \notin S, \end{cases} \quad (7.2.18)$$

then

$$\int_S f(x, y) d(x, y) = \int_R f_S(x, y) d(x, y),$$

where  $R = [a, b] \times [c, d]$ . From Theorem 7.2.1,

$$\int_R f_S(x, y) d(x, y) = \int_c^d dy \int_a^b f_S(x, y) dx$$

provided that  $\int_a^b f_S(x, y) dx$  exists for each  $y$  in  $[c, d]$ . From (7.2.17) and (7.2.18), this integral can be written as

$$\int_{u(y)}^{v(y)} f(x, y) dx. \quad (7.2.19)$$

Thus, we have proved the following theorem.

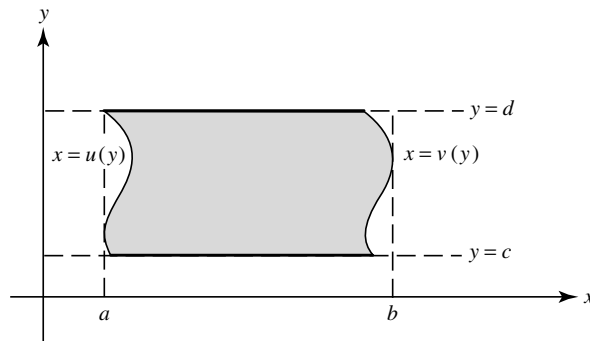


Figure 7.2.1

**Theorem 7.2.6** If  $f$  is integrable on the set  $S$  in (7.2.17) and the integral (7.2.19) exists for  $c \leq y \leq d$ , then

$$\int_S f(x, y) d(x, y) = \int_c^d dy \int_{u(y)}^{v(y)} f(x, y) dx. \quad (7.2.20)$$



From Theorem 7.1.22, the assumptions of Theorem 7.2.6 are satisfied if  $f$  is continuous on  $S$  and  $u$  and  $v$  are continuously differentiable on  $[c, d]$ .

Interchanging  $x$  and  $y$  in Theorem 7.2.6 shows that if  $f$  is integrable on

$$S = \{(x, y) \mid u(x) \leq y \leq v(x), a \leq x \leq b\} \quad (7.2.21)$$

(Figure 7.2.2) and

$$\int_{u(x)}^{v(x)} f(x, y) dy$$

exists for  $a \leq x \leq b$ , then

$$\int_S f(x, y) d(x, y) = \int_a^b dx \int_{u(x)}^{v(x)} f(x, y) dy. \quad (7.2.22)$$

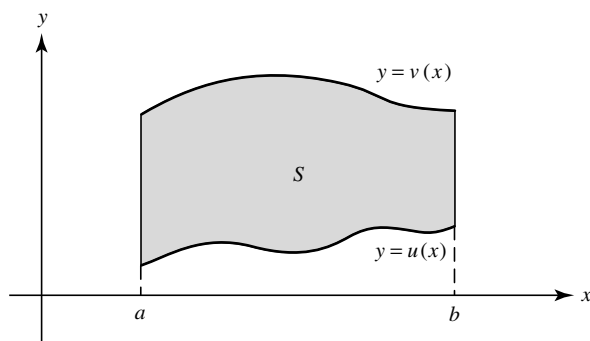


Figure 7.2.2

**Example 7.2.6** Suppose that

$$f(x, y) = xy$$

and  $S$  is the region bounded by the curves  $x = y^2$  and  $x = y$  (Figure 7.2.3). Since  $S$  can be represented in the form (7.2.17) as

$$S = \{(x, y) \mid y^2 \leq x \leq y, 0 \leq y \leq 1\},$$

(7.2.20) yields

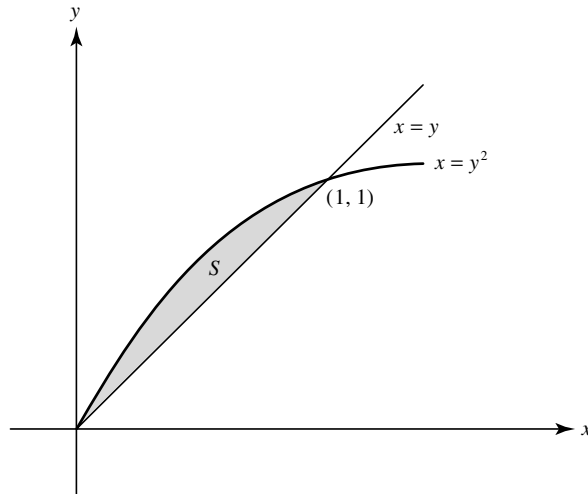
$$\int_S xy d(x, y) = \int_0^1 dy \int_{y^2}^y xy dx,$$

which, incidentally, can be written as

$$\int_S xy d(x, y) = \int_0^1 y dy \int_{y^2}^y x dx,$$

since  $y$  is independent of  $x$ . Evaluating the iterated integral yields

$$\begin{aligned}\int_S xy \, d(x, y) &= \int_0^1 \left( \frac{x^2}{2} \Big|_{y^2}^y \right) y \, dy = \frac{1}{2} \int_0^1 (y^3 - y^5) \, dy \\ &= \frac{1}{2} \left( \frac{y^4}{4} - \frac{y^6}{6} \right) \Big|_0^1 = \frac{1}{24}.\end{aligned}$$



**Figure 7.2.3**

In this case we can also represent  $S$  in the form (7.2.21) as

$$S = \{(x, y) \mid x \leq y \leq \sqrt{x}, 0 \leq x \leq 1\};$$

hence, from (7.2.22),

$$\begin{aligned}\int_S xy \, d(x, y) &= \int_0^1 x \, dx \int_x^{\sqrt{x}} y \, dy = \int_0^1 \left( \frac{y^2}{2} \Big|_{y=x}^{\sqrt{x}} \right) x \, dx \\ &= \frac{1}{2} \int_0^1 (x^2 - x^3) \, dx = \frac{1}{2} \left( \frac{x^3}{3} - \frac{x^4}{4} \right) \Big|_0^1 = \frac{1}{24}.\end{aligned}$$

**Example 7.2.7** To evaluate

$$\int_S (x + y) \, d(x, y),$$

where

$$S = \{(x, y) \mid -1 \leq x \leq 1, 0 \leq y \leq 1 + |x|\}$$

(see Example 7.1.11 and Figure 7.2.4),

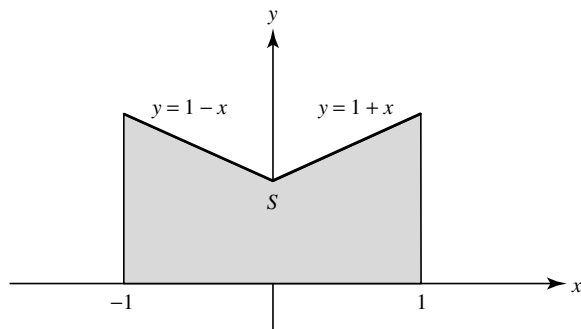


Figure 7.2.4

we invoke Corollary 7.1.31 and write

$$\int_S (x + y) d(x, y) = \int_{S_1} (x + y) d(x, y) + \int_{S_2} (x + y) d(x, y),$$

where

$$S_1 = \{(x, y) \mid 0 \leq x \leq 1, 0 \leq y \leq 1 + x\}$$

and

$$S_2 = \{(x, y) \mid -1 \leq x \leq 0, 0 \leq y \leq 1 - x\}$$

(Figure 7.2.5).

From Theorem 7.2.6,

$$\begin{aligned} \int_{S_1} (x + y) d(x, y) &= \int_0^1 dx \int_0^{1+x} (x + y) dy = \int_0^1 \left[ \frac{(x + y)^2}{2} \Big|_{y=0}^{1+x} \right] dx \\ &= \frac{1}{2} \int_0^1 [(2x + 1)^2 - x^2] dx \\ &= \frac{1}{2} \left[ \frac{(2x + 1)^3}{6} - \frac{x^3}{3} \right] \Big|_0^1 = 2 \end{aligned}$$

and

$$\begin{aligned} \int_{S_2} (x + y) d(x, y) &= \int_{-1}^0 dx \int_0^{1-x} (x + y) dy = \int_{-1}^0 \left[ \frac{(x + y)^2}{2} \Big|_{y=0}^{1-x} \right] dx \\ &= \frac{1}{2} \int_{-1}^0 (1 - x^2) dx = \frac{1}{2} \left( x - \frac{x^3}{3} \right) \Big|_{-1}^0 = \frac{1}{3}. \end{aligned}$$

Therefore,

$$\int_S (x + y) d(x, y) = 2 + \frac{1}{3} = \frac{7}{3}.$$

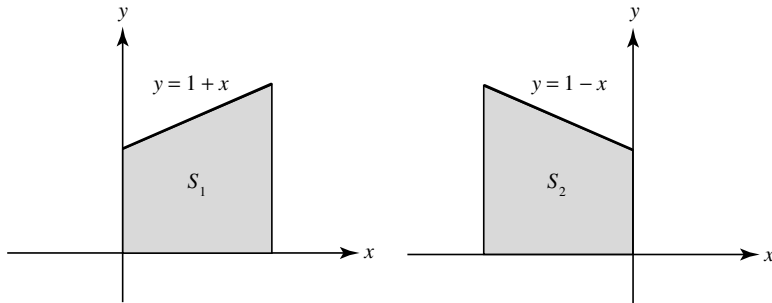


Figure 7.2.5

**Example 7.2.8** To find the area  $A$  of the region bounded by the curves

$$y = x^2 + 1 \quad \text{and} \quad y = 9 - x^2$$

(Figure 7.2.6), we evaluate

$$A = \int_S d(x, y),$$

where

$$S = \{(x, y) \mid x^2 + 1 \leq y \leq 9 - x^2, -2 \leq x \leq 2\}.$$

According to Theorem 7.2.6,

$$\begin{aligned} A &= \int_{-2}^2 dx \int_{x^2+1}^{9-x^2} dy = \int_{-2}^2 [(9 - x^2) - (x^2 + 1)] dx \\ &= \int_{-2}^2 (8 - 2x^2) dx = \left( 8x - \frac{2x^3}{3} \right) \Big|_{-2}^2 = \frac{64}{3}. \end{aligned}$$

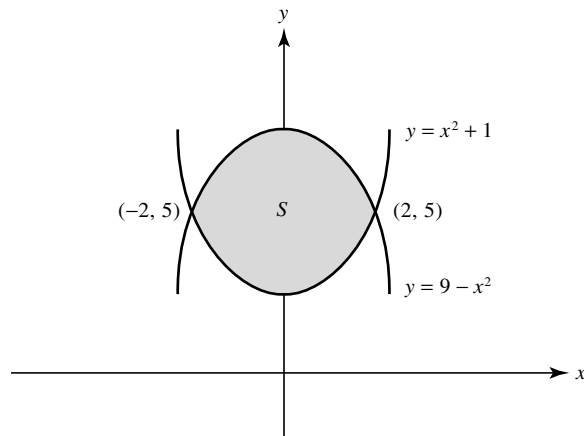


Figure 7.2.6

Theorem 7.2.6 has an analog for  $n > 2$ . Suppose that  $f$  is integrable on a set  $S$  of points  $\mathbf{X} = (x_1, x_2, \dots, x_n)$  satisfying the inequalities

$$u_j(x_{j+1}, \dots, x_n) \leq x_j \leq v_j(x_{j+1}, \dots, x_n), \quad 1 \leq j \leq n-1,$$

and

$$a_n \leq x_n \leq b_n.$$

Then, under appropriate additional assumptions, it can be shown by an argument analogous to the one that led to Theorem 7.2.6 that

$$\int_S f(\mathbf{X}) d\mathbf{X} = \int_{a_n}^{b_n} dx_n \int_{u_n(x_n)}^{v_n(x_n)} dx_{n-1} \cdots \int_{u_2(x_3, \dots, x_n)}^{v_2(x_3, \dots, x_n)} dx_2 \int_{u_1(x_2, \dots, x_n)}^{v_1(x_2, \dots, x_n)} f(\mathbf{X}) dx_1.$$

These additional assumptions are tedious to state for general  $n$ . The following theorem contains a complete statement for  $n = 3$ .

**Theorem 7.2.7** Suppose that  $f$  is integrable on

$$S = \{(x, y, z) \mid u_1(y, z) \leq x \leq v_1(y, z), u_2(z) \leq y \leq v_2(z), c \leq z \leq d\},$$

and let

$$S(z) = \{(x, y) \mid u_1(y, z) \leq x \leq v_1(y, z), u_2(z) \leq y \leq v_2(z)\}$$

for each  $z$  in  $[c, d]$ . Then

$$\int_S f(x, y, z) d(x, y, z) = \int_c^d dz \int_{u_2(z)}^{v_2(z)} dy \int_{u_1(y, z)}^{v_1(y, z)} f(x, y, z) dx,$$

provided that

$$\int_{u_1(y, z)}^{v_1(y, z)} f(x, y, z) dx$$

exists for all  $(y, z)$  such that

$$c \leq z \leq d \quad \text{and} \quad u_2(z) \leq y \leq v_2(z),$$

and

$$\int_{S(z)} f(x, y, z) d(x, y)$$

exists for all  $z$  in  $[c, d]$ .

**Example 7.2.9** Suppose that  $f$  is continuous on the region  $S$  in  $\mathbb{R}^3$  bounded by the coordinate planes and the plane

$$x + y + 2z = 2$$

(Figure 7.2.7); thus,

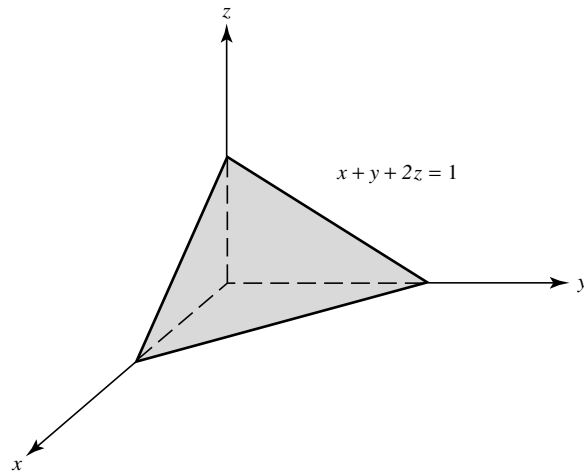


Figure 7.2.7

$$S = \{(x, y, z) \mid 0 \leq x \leq 2 - y - 2z, 0 \leq y \leq 2 - 2z, 0 \leq z \leq 1\}.$$

From Theorem 7.2.7,

$$\int_S f(x, y, z) d(x, y, z) = \int_0^1 dz \int_0^{2-2z} dy \int_0^{2-y-2z} f(x, y, z) dx.$$

There are five other iterated integrals that equal the multiple integral. We leave it to you to verify that

$$\begin{aligned} \int_S f(x, y, z) d(x, y, z) &= \int_0^2 dy \int_0^{1-y/2} dz \int_0^{2-y-2z} f(x, y, z) dx \\ &= \int_0^1 dz \int_0^{2-2z} dx \int_0^{2-x-2z} f(x, y, z) dy \\ &= \int_0^2 dx \int_0^{1-x/2} dz \int_0^{2-x-2z} f(x, y, z) dy \\ &= \int_0^2 dx \int_0^{2-x} dy \int_0^{1-x/2-y/2} f(x, y, z) dz \\ &= \int_0^2 dy \int_0^{2-y} dx \int_0^{1-x/2-y/2} f(x, y, z) dz \quad \blacksquare \end{aligned}$$

(Exercise 7.2.15).

Thus far we have viewed the iterated integral as a tool for evaluating multiple integrals. In some problems the iterated integral is itself the object of interest. In this case a result

like Theorem 7.2.6 can be used to evaluate the iterated integral. The procedure is as follows.

- (a) Express the given iterated integral as a multiple integral, and check to see that the multiple integral exists.
- (b) Look for another iterated integral that equals the multiple integral and is easier to evaluate than the given one. The two iterated integrals must be equal, by Theorem 7.2.6.

This procedure is called *changing the order of integration* of an iterated integral.

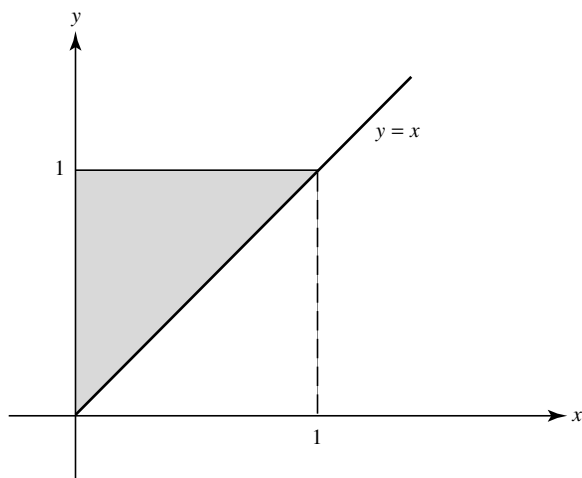
**Example 7.2.10** The iterated integral

$$I = \int_0^1 dy \int_0^y e^{-(x-1)^2} dx$$

is hard to evaluate because  $e^{-(x-1)^2}$  has no elementary antiderivative. The set of points  $(x, y)$  that enter into the integration, which we call the *region of integration*, is

$$S = \{(x, y) \mid 0 \leq x \leq y, 0 \leq y \leq 1\}$$

(Figure 7.2.8).



**Figure 7.2.8**

Therefore,

$$I = \int_S e^{-(x-1)^2} d(x, y), \quad (7.2.23)$$

and this multiple integral exists because its integrand is continuous. Since  $S$  can also be written as

$$S = \{(x, y) \mid x \leq y \leq 1, 0 \leq x \leq 1\},$$

Theorem 7.2.6 implies that

$$\begin{aligned}\int_S e^{-(x-1)^2} d(x, y) &= \int_0^1 e^{-(x-1)^2} dx \int_x^1 dy = - \int_0^1 (x-1)e^{-(x-1)^2} dx \\ &= \frac{1}{2} e^{-(x-1)^2} \Big|_0^1 = \frac{1}{2} (1 - e^{-1}).\end{aligned}$$

This and (7.2.23) imply that

$$I = \frac{1}{2} (1 - e^{-1}).$$

**Example 7.2.11** Suppose that  $f$  is continuous on  $[a, \infty)$  and  $y$  satisfies the differential equation

$$y''(x) = f(x), \quad x > a, \quad (7.2.24)$$

with initial conditions

$$y(a) = y'(a) = 0.$$

Integrating (7.2.24) yields

$$y'(x) = \int_a^x f(t) dt,$$

since  $y'(a) = 0$ . Integrating this yields

$$y(x) = \int_a^x ds \int_a^s f(t) dt,$$

since  $y(a) = 0$ . This can be reduced to a single integral as follows. Since the function

$$g(s, t) = f(t)$$

is continuous for all  $(s, t)$  such that  $t \geq a$ ,  $g$  is integrable on

$$S = \{(s, t) \mid a \leq t \leq s, a \leq s \leq x\}$$

(Figure 7.2.9), and Theorem 7.2.6 implies that

$$\int_S f(t) d(s, t) = \int_a^x ds \int_a^s f(t) dt = y(x). \quad (7.2.25)$$

However,  $S$  can also be described as

$$S = \{(s, t) \mid t \leq s \leq x, a \leq t \leq x\}$$

so Theorem 7.2.6 implies that

$$\int_S f(t) d(s, t) = \int_a^x f(t) dt \int_t^x ds = \int_a^x (x-t)f(t) dt.$$

Comparing this with (7.2.25) yields

$$y(x) = \int_a^x (x-t)f(t) dt.$$



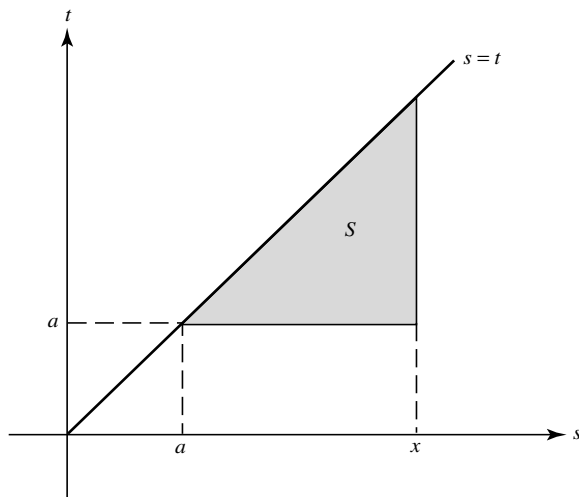


Figure 7.2.9

## 7.2 Exercises

1. Evaluate

(a)  $\int_0^2 dy \int_{-1}^1 (x + 3y) dx$

(b)  $\int_1^2 dx \int_0^1 (x^3 + y^4) dy$

(c)  $\int_{\pi/2}^{2\pi} x dx \int_1^2 \sin xy dy$

(d)  $\int_0^{\log 2} y dy \int_0^1 xe^{x^2y} dx$

2. Let  $I_j = [a_j, b_j]$ ,  $1 \leq j \leq 3$ , and suppose that  $f$  is integrable on  $R = I_1 \times I_2 \times I_3$ . Prove:

(a) If the integral

$$G(y, z) = \int_{a_1}^{b_1} f(x, y, z) dx$$

exists for  $(y, z) \in I_2 \times I_3$ , then  $G$  is integrable on  $I_2 \times I_3$  and

$$\int_R f(x, y, z) d(x, y, z) = \int_{I_2 \times I_3} G(y, z) d(y, z).$$

(b) If the integral

$$H(z) = \int_{I_1 \times I_2} f(x, y, z) d(x, y)$$

exists for  $z \in I_3$ , then  $H$  is integrable on  $I_3$  and

$$\int_R f(x, y, z) d(x, y, z) = \int_{a_3}^{b_3} H(z) dz.$$

HINT: For both parts, see the proof of Theorem 7.2.1.

3. Prove: If  $f$  is continuous on  $[a, b] \times [c, d]$ , then the function

$$F(y) = \int_a^b f(x, y) dx$$

is continuous on  $[c, d]$ . HINT: Use Theorem 5.2.14.

4. Suppose that

$$f(x', y') \geq f(x, y) \quad \text{if} \quad a \leq x \leq x' \leq b, \quad c \leq y \leq y' \leq d.$$

Show that  $f$  satisfies the hypotheses of Theorem 7.2.1 on  $R = [a, b] \times [c, d]$ . HINT: See the proof of Theorem 3.2.9.

5. Evaluate by means of iterated integrals:

(a)  $\int_R (xy + 1) d(x, y); \quad R = [0, 1] \times [1, 2]$

(b)  $\int_R (2x + 3y) d(x, y); \quad R = [1, 3] \times [1, 2]$

(c)  $\int_R \frac{xy}{\sqrt{x^2 + y^2}} d(x, y); \quad R = [0, 1] \times [0, 1]$

(d)  $\int_R x \cos xy \cos 2\pi x d(x, y); \quad R = [0, \frac{1}{4}] \times [0, 2\pi]$

6. Let  $A$  be the set of points of the form  $(2^{-m}p, 2^{-m}q)$ , where  $p$  and  $q$  are odd integers and  $m$  is a nonnegative integer. Let

$$f(x, y) = \begin{cases} 1, & (x, y) \notin A, \\ 0, & (x, y) \in A. \end{cases}$$

Show that  $f$  is not integrable on any rectangle  $R = [a, b] \times [c, d]$ , but

$$\int_a^b dx \int_c^d f(x, y) dy = \int_c^d dy \int_a^b f(x, y) dx = (b - a)(d - c). \quad (\text{A})$$

HINT: For (A), use Theorem 3.5.6 and Exercise 3.5.6.

7. Let

$$f(x, y) = \begin{cases} 2xy & \text{if } y \text{ is rational,} \\ y & \text{if } y \text{ is irrational,} \end{cases}$$

and  $R = [0, 1] \times [0, 1]$  (Example 7.2.3).

- (a) Calculate  $\int_R f(x, y) d(x, y)$  and  $\overline{\int}_R f(x, y) d(x, y)$ , and show that  $f$  is not integrable on  $R$ .
- (b) Calculate  $\int_0^1 \left( \int_0^1 f(x, y) dy \right) dx$  and  $\int_0^1 \left( \overline{\int}_0^1 f(x, y) dy \right) dx$ .
8. Let  $R = [0, 1] \times [0, 1] \times [0, 1]$ ,  $\widetilde{R} = [0, 1] \times [0, 1]$ , and

$$f(x, y, z) = \begin{cases} 2xy + 2xz & \text{if } y \text{ and } z \text{ are rational,} \\ y + 2xz & \text{if } y \text{ is irrational and } z \text{ is rational,} \\ 2xy + z & \text{if } y \text{ is rational and } z \text{ is irrational,} \\ y + z & \text{if } y \text{ and } z \text{ are irrational.} \end{cases}$$

Calculate

- (a)  $\int_R f(x, y, z) d(x, y, z)$  and  $\overline{\int}_R f(x, y, z) d(x, y, z)$
- (b)  $\int_R f(x, y, z) d(x, y)$  and  $\overline{\int}_R f(x, y, z) d(x, y)$
- (c)  $\int_0^1 dy \int_0^1 f(x, y, z) dx$  and  $\int_0^1 dz \int_0^1 dy \int_0^1 f(x, y, z) dx$ .
9. Suppose that  $f$  is bounded on  $R = [a, b] \times [c, d]$ . Prove:
- (a)  $\int_R f(x, y) d(x, y) \leq \int_a^b \left( \int_c^d f(x, y) dy \right) dx$ . HINT: Use Exercise 3.2.6(a).
- (b)  $\overline{\int}_R f(x, y) d(x, y) \geq \int_a^b \left( \overline{\int}_c^d f(x, y) dy \right) dx$ . HINT: Use Exercise 3.2.6(b).
10. Use Exercise 7.2.9 to prove the following generalization of Theorem 7.2.1: If  $f$  is integrable on  $R = [a, b] \times [c, d]$ , then

$$\int_a^b f(x, y) dy \quad \text{and} \quad \int_c^d f(x, y) dy$$

are integrable on  $[a, b]$ , and

$$\int_a^b \left( \overline{\int}_c^d f(x, y) dy \right) dx = \int_a^b \left( \int_c^d f(x, y) dy \right) dx = \int_R f(x, y) d(x, y).$$

11. Evaluate

- (a)  $\int_R (x - 2y + 3z) d(x, y, z)$ ;  $R = [-2, 0] \times [2, 5] \times [-3, 2]$
- (b)  $\int_R e^{-x^2-y^2} \sin x \sin z d(x, y, z)$ ;  $R = [-1, 1] \times [0, 2] \times [0, \pi/2]$
- (c)  $\int_R (xy + 2xz + yz) d(x, y, z)$ ;  $R = [-1, 1] \times [0, 1] \times [-1, 1]$

- (d)  $\int_R x^2 y^3 z e^{xy^2 z^2} d(x, y, z); \quad R = [0, 1] \times [0, 1] \times [0, 1]$
12. Evaluate
- (a)  $\int_S (2x + y^2) d(x, y); \quad S = \{(x, y) \mid 0 \leq x \leq 9 - y^2, -3 \leq y \leq 3\}$
- (b)  $\int_S 2xy d(x, y); \quad S$  is bounded by  $y = x^2$  and  $x = y^2$
- (c)  $\int_S e^x \frac{\sin y}{y} d(x, y); \quad S = \{(x, y) \mid \log y \leq x \leq \log 2y, \pi/2 \leq y \leq \pi\}$
13. Evaluate  $\int_S (x + y) d(x, y)$ , where  $S$  is bounded by  $y = x^2$  and  $y = 2x$ , using iterated integrals of both possible types.
14. Find the area of the set bounded by the given curves.
- (a)  $y = x^2 + 9, y = x^2 - 9, x = -1, x = 1$
- (b)  $y = x + 2, y = 4 - x, x = 0$
- (c)  $x = y^2 - 4, x = 4 - y^2$
- (d)  $y = e^{2x}, y = -2x, x = 3$
15. In Example 7.2.9, verify the last five representations of  $\int_S f(x, y, z) d(x, y, z)$  as iterated integrals.
16. Let  $S$  be the region in  $\mathbb{R}^3$  bounded by the coordinate planes and the plane  $x + 2y + 3z = 1$ . Let  $f$  be continuous on  $S$ . Set up six iterated integrals that equal  $\int_S f(x, y, z) d(x, y, z)$ .
17. Evaluate
- (a)  $\int_S x d(x, y, z); \quad S$  is bounded by the coordinate planes and the plane  $3x + y + z = 2$ .
- (b)  $\int_S ye^z d(x, y, z); \quad S = \{(x, y, z) \mid 0 \leq x \leq 1, 0 \leq y \leq \sqrt{x}, 0 \leq z \leq y^2\}$
- (c)  $\int_S xyz d(x, y, z);$   
 $S = \{(x, y, z) \mid 0 \leq y \leq 1, 0 \leq x \leq \sqrt{1 - y^2}, 0 \leq z \leq \sqrt{x^2 + y^2}\}$
- (d)  $\int_S yz d(x, y, z); \quad S = \{(x, y, z) \mid z^2 \leq x \leq \sqrt{z}, 0 \leq y \leq z, 0 \leq z \leq 1\}$
18. Find the volume of  $S$ .
- (a)  $S$  is bounded by the surfaces  $z = x^2 + y^2$  and  $z = 8 - x^2 - y^2$ .
- (b)  $S = \{(x, y, z) \mid 0 \leq z \leq x^2 + y^2, (x, y, 0)$  is in the triangle with vertices  $(0, 1, 0), (0, 0, 0)$ , and  $(1, 0, 0)\}$
- (c)  $S = \{(x, y, z) \mid 0 \leq y \leq x^2, 0 \leq x \leq 2, 0 \leq z \leq y^2\}$
- (d)  $S = \{(x, y, z) \mid x \geq 0, y \geq 0, 0 \leq z \leq 4 - 4x^2 - 4y^2\}$

19. Let  $R = [a_1, b_1] \times [a_2, b_2] \times \cdots \times [a_n, b_n]$ . Evaluate
- (a)  $\int_R (x_1 + x_2 + \cdots + x_n) d\mathbf{X}$       (b)  $\int_R (x_1^2 + x_2^2 + \cdots + x_n^2) d\mathbf{X}$
- (c)  $\int_R x_1 x_2 \cdots x_n d\mathbf{X}$
20. Assuming that  $f$  is continuous, express

$$\int_{1/2}^1 dy \int_{-\sqrt{1-y^2}}^{\sqrt{1-y^2}} f(x, y) dx$$

as an iterated integral with the order of integration reversed.

21. Evaluate  $\int_S (x+y) d(x, y)$  of Example 7.2.7 by means of iterated integrals in which the first integration is with respect to  $x$ .
22. Evaluate  $\int_0^1 x dx \int_0^{\sqrt{1-x^2}} \frac{dy}{\sqrt{x^2+y^2}}$ .
23. Suppose that  $f$  is continuous on  $[a, \infty)$ ,

$$y^{(n)}(x) = f(x), \quad t \geq a,$$

and  $y(a) = y'(a) = \cdots = y^{(n-1)}(a) = 0$ .

(a) Integrate repeatedly to show that

$$y(x) = \int_a^x dt_n \int_a^{t_n} dt_{n-1} \cdots \int_a^{t_3} dt_2 \int_a^{t_2} f(t_1) dt_1. \quad (\text{A})$$

(b) By successive reversals of orders of integration as in Example 7.2.11, deduce from (A) that

$$y(x) = \frac{1}{(n-1)!} \int_a^x (x-t)^{n-1} f(t) dt.$$

24. Let  $T_\rho = [0, \rho] \times [0, \rho]$ ,  $\rho > 0$ . By calculating

$$I(a) = \lim_{\rho \rightarrow \infty} \int_{T_\rho} e^{-xy} \sin ax d(x, y)$$

in two different ways, show that

$$\int_0^\infty \frac{\sin ax}{x} dx = \frac{\pi}{2} \quad \text{if } a > 0.$$

### 7.3 CHANGE OF VARIABLES IN MULTIPLE INTEGRALS

In Section 3.3 we saw that a change of variables may simplify the evaluation of an ordinary integral. We now consider change of variables in multiple integrals.

Prior to formulating the rule for change of variables, we must deal with some rather involved preliminary considerations.

### Jordan Measurable Sets

In Section we defined the content of a set  $S$  to be

$$V(S) = \int_S d\mathbf{X} \quad (7.3.1)$$

if the integral exists. If  $R$  is a rectangle containing  $S$ , then (7.3.1) can be rewritten as

$$V(S) = \int_R \psi_S(\mathbf{X}) d\mathbf{X},$$

where  $\psi_S$  is the characteristic function of  $S$ , defined by

$$\psi_S(\mathbf{X}) = \begin{cases} 1, & \mathbf{X} \in S, \\ 0, & \mathbf{X} \notin S. \end{cases}$$

From Exercise 7.1.27, the existence and value of  $V(S)$  do not depend on the particular choice of the enclosing rectangle  $R$ . We say that  $S$  is *Jordan measurable* if  $V(S)$  exists. Then  $V(S)$  is the *Jordan content* of  $S$ .

We leave it to you (Exercise 7.3.2) to show that  $S$  has zero content according to Definition 7.1.14 if and only if  $S$  has Jordan content zero.

**Theorem 7.3.1** *A bounded set  $S$  is Jordan measurable if and only if the boundary of  $S$  has zero content.*

**Proof** Let  $R$  be a rectangle containing  $S$ . Suppose that  $V(\partial S) = 0$ . Since  $\psi_S$  is bounded on  $R$  and discontinuous only on  $\partial S$  (Exercise 2.2.9), Theorem 7.1.19 implies that  $\int_R \psi_S(\mathbf{X}) d\mathbf{X}$  exists. For the converse, suppose that  $\partial S$  does not have zero content and let  $P = \{R_1, R_2, \dots, R_k\}$  be a partition of  $R$ . For each  $j$  in  $\{1, 2, \dots, k\}$  there are three possibilities:

1.  $R_j \subset S$ ; then

$$\min \{\psi_S(\mathbf{X}) \mid \mathbf{X} \in R_j\} = \max \{\psi_S(\mathbf{X}) \mid \mathbf{X} \in R_j\} = 1.$$

2.  $R_j \cap S \neq \emptyset$  and  $R_j \cap S^c \neq \emptyset$ ; then

$$\min \{\psi_S(\mathbf{X}) \mid \mathbf{X} \in R_j\} = 0 \quad \text{and} \quad \max \{\psi_S(\mathbf{X}) \mid \mathbf{X} \in R_j\} = 1.$$

3.  $R_j \subset S^c$ ; then

$$\min \{\psi_S(\mathbf{X}) \mid \mathbf{X} \in R_j\} = \max \{\psi_S(\mathbf{X}) \mid \mathbf{X} \in R_j\} = 0.$$

Let

$$\mathcal{U}_1 = \{j \mid R_j \subset S\} \quad \text{and} \quad \mathcal{U}_2 = \{j \mid R_j \cap S \neq \emptyset \text{ and } R_j \cap S^c \neq \emptyset\}. \quad (7.3.2)$$

Then the upper and lower sums of  $\psi_S$  over  $P$  are

$$\begin{aligned} S(P) &= \sum_{j \in \mathcal{U}_1} V(R_j) + \sum_{j \in \mathcal{U}_2} V(R_j) \\ &= \text{total content of the subrectangles in } P \text{ that intersect } S \end{aligned} \quad (7.3.3)$$

and

$$\begin{aligned} s(P) &= \sum_{j \in \mathcal{U}_1} V(R_j) \\ &= \text{total content of the subrectangles in } P \text{ contained in } S. \end{aligned} \quad (7.3.4)$$

Therefore,

$$S(P) - s(P) = \sum_{j \in \mathcal{U}_2} V(R_j),$$

which is the total content of the subrectangles in  $P$  that intersect both  $S$  and  $S^c$ . Since these subrectangles contain  $\partial S$ , which does not have zero content, there is an  $\epsilon_0 > 0$  such that

$$S(P) - s(P) \geq \epsilon_0$$

for every partition  $P$  of  $R$ . By Theorem 7.1.12, this implies that  $\psi_S$  is not integrable on  $R$ , so  $S$  is not Jordan measurable. ■

Theorems 7.1.19 and 7.3.1 imply the following corollary.

**Corollary 7.3.2** *If  $f$  is bounded and continuous on a bounded Jordan measurable set  $S$ , then  $f$  is integrable on  $S$ .*

**Lemma 7.3.3** *Suppose that  $K$  is a bounded set with zero content and  $\epsilon, \rho > 0$ . Then there are cubes  $C_1, C_2, \dots, C_r$  with edge lengths  $< \rho$  such that  $C_j \cap K \neq \emptyset, 1 \leq j \leq r$ ,*

$$K \subset \bigcup_{j=1}^r C_j, \quad (7.3.5)$$

and

$$\sum_{j=1}^r V(C_j) < \epsilon.$$

**Proof** Since  $V(K) = 0$ ,

$$\int_C \psi_K(\mathbf{X}) d\mathbf{X} = 0$$

if  $C$  is any cube containing  $K$ . From this and the definition of the integral, there is a  $\delta > 0$  such that if  $P$  is any partition of  $C$  with  $\|P\| \leq \delta$  and  $\sigma$  is any Riemann sum of  $\psi_K$  over  $P$ , then

$$0 \leq \sigma \leq \epsilon. \quad (7.3.6)$$

Now suppose that  $P = \{C_1, C_2, \dots, C_k\}$  is a partition of  $C$  into cubes with

$$\|P\| < \min(\rho, \delta), \quad (7.3.7)$$

and let  $C_1, C_2, \dots, C_k$  be numbered so that  $C_j \cap K \neq \emptyset$  if  $1 \leq j \leq r$  and  $C_j \cap K = \emptyset$  if  $r+1 \leq j \leq k$ . Then (7.3.5) holds, and a typical Riemann sum of  $\psi_K$  over  $P$  is of the form

$$\sigma = \sum_{j=1}^r \psi_K(\mathbf{X}_j) V(C_j)$$

with  $\mathbf{X}_j \in C_j$ ,  $1 \leq j \leq r$ . In particular, we can choose  $\mathbf{X}_j$  from  $K$ , so that  $\psi_K(\mathbf{X}_j) = 1$ , and

$$\sigma = \sum_{j=1}^r V(C_j).$$

Now (7.3.6) and (7.3.7) imply that  $C_1, C_2, \dots, C_r$  have the required properties. ■

### Transformations of Jordan-Measurable Sets

To formulate the theorem on change of variables in multiple integrals, we must first consider the question of preservation of Jordan measurability under a regular transformation.

**Lemma 7.3.4** *Suppose that  $\mathbf{G} : \mathbb{R}^n \rightarrow \mathbb{R}^n$  is continuously differentiable on a bounded open set  $S$ , and let  $K$  be a closed subset of  $S$  with zero content. Then  $\mathbf{G}(K)$  has zero content.*

**Proof** Since  $K$  is a compact subset of the open set  $S$ , there is a  $\rho_1 > 0$  such that the compact set

$$K_{\rho_1} = \{\mathbf{X} \mid \text{dist}(\mathbf{X}, K) \leq \rho_1\}$$

is contained in  $S$  (Exercise 5.1.26). From Lemma 6.2.7, there is a constant  $M$  such that

$$|\mathbf{G}(\mathbf{Y}) - \mathbf{G}(\mathbf{X})| \leq M|\mathbf{Y} - \mathbf{X}| \quad \text{if } \mathbf{X}, \mathbf{Y} \in K_{\rho_1}. \quad (7.3.8)$$

Now suppose that  $\epsilon > 0$ . Since  $V(K) = 0$ , there are cubes  $C_1, C_2, \dots, C_r$  with edge lengths  $s_1, s_2, \dots, s_r < \rho_1/\sqrt{n}$  such that  $C_j \cap K \neq \emptyset$ ,  $1 \leq j \leq r$ ,

$$K \subset \bigcup_{j=1}^r C_j,$$

and

$$\sum_{j=1}^r V(C_j) < \epsilon \quad (7.3.9)$$

(Lemma 7.3.3). For  $1 \leq j \leq r$ , let  $\mathbf{X}_j \in C_j \cap K$ . If  $\mathbf{X} \in C_j$ , then

$$|\mathbf{X} - \mathbf{X}_j| \leq s_j \sqrt{n} < \rho_1,$$



so  $\mathbf{X} \in K$  and  $|\mathbf{G}(\mathbf{X}) - \mathbf{G}(\mathbf{X}_j)| \leq M|\mathbf{X} - \mathbf{X}_j| \leq M\sqrt{n}s_j$ , from (7.3.8). Therefore,  $\mathbf{G}(C_j)$  is contained in a cube  $\tilde{C}_j$  with edge length  $2M\sqrt{n}s_j$ , centered at  $\mathbf{G}(\mathbf{X}_j)$ . Since

$$V(\tilde{C}_j) = (2M\sqrt{n})^n s_j^n = (2M\sqrt{n})^n V(C_j),$$

we now see that

$$\mathbf{G}(K) \subset \bigcup_{j=1}^r \tilde{C}_j$$

and

$$\sum_{j=1}^r V(\tilde{C}_j) \leq (2M\sqrt{n})^n \sum_{j=1}^r V(C_j) < (2M\sqrt{n})^n \epsilon,$$

where the last inequality follows from (7.3.9). Since  $(2M\sqrt{n})^n$  does not depend on  $\epsilon$ , it follows that  $V(\mathbf{G}(K)) = 0$ . ■

**Theorem 7.3.5** Suppose that  $\mathbf{G} : \mathbb{R}^n \rightarrow \mathbb{R}^n$  is regular on a compact Jordan measurable set  $S$ . Then  $\mathbf{G}(S)$  is compact and Jordan measurable.

**Proof** We leave it to you to prove that  $\mathbf{G}(S)$  is compact (Exercise 6.2.23). Since  $S$  is Jordan measurable,  $V(\partial S) = 0$ , by Theorem 7.3.1. Therefore,  $V(\mathbf{G}(\partial S)) = 0$ , by Lemma 7.3.4. But  $\mathbf{G}(\partial S) = \partial(\mathbf{G}(S))$  (Exercise 6.3.23), so  $V(\partial(\mathbf{G}(S))) = 0$ , which implies that  $\mathbf{G}(S)$  is Jordan measurable, again by Theorem 7.3.1. ■

### Change of Content Under a Linear Transformation

To motivate and prove the rule for change of variables in multiple integrals, we must know how  $V(\mathbf{L}(S))$  is related to  $V(S)$  if  $S$  is a compact Jordan measurable set and  $\mathbf{L}$  is a nonsingular linear transformation. (From Theorem 7.3.5,  $\mathbf{L}(S)$  is compact and Jordan measurable in this case.) The next lemma from linear algebra will help to establish this relationship. We omit the proof.

**Lemma 7.3.6** A nonsingular  $n \times n$  matrix  $\mathbf{A}$  can be written as

$$\mathbf{A} = \mathbf{E}_k \mathbf{E}_{k-1} \cdots \mathbf{E}_1, \quad (7.3.10)$$

where each  $\mathbf{E}_i$  is a matrix that can be obtained from the  $n \times n$  identity matrix  $\mathbf{I}$  by one of the following operations:

- (a) interchanging two rows of  $\mathbf{I}$ ;
- (b) multiplying a row of  $\mathbf{I}$  by a nonzero constant;
- (c) adding a multiple of one row of  $\mathbf{I}$  to another.

Matrices of the kind described in this lemma are called *elementary* matrices. The key to the proof of the lemma is that if  $\mathbf{E}$  is an elementary  $n \times n$  matrix and  $\mathbf{A}$  is any  $n \times n$  matrix, then  $\mathbf{EA}$  is the matrix obtained by applying to  $\mathbf{A}$  the same operation that must be applied to  $\mathbf{I}$  to produce  $\mathbf{E}$  (Exercise 7.3.6). Also, the inverse of an elementary matrix of type (a), (b), or (c) is an elementary matrix of the same type (Exercise 7.3.7).

The next example illustrates the procedure for finding the factorization (7.3.10).

**Example 7.3.1** The matrix

$$\mathbf{A} = \begin{bmatrix} 0 & 1 & 1 \\ 1 & 0 & 1 \\ 2 & 2 & 0 \end{bmatrix}$$

is nonsingular, since  $\det(\mathbf{A}) = 4$ . Interchanging the first two rows of  $\mathbf{A}$  yields

$$\mathbf{A}_1 = \begin{bmatrix} 1 & 0 & 1 \\ 0 & 1 & 1 \\ 2 & 2 & 0 \end{bmatrix} = \widehat{\mathbf{E}}_1 \mathbf{A},$$

where

$$\widehat{\mathbf{E}}_1 = \begin{bmatrix} 0 & 1 & 0 \\ 1 & 0 & 0 \\ 0 & 0 & 1 \end{bmatrix}.$$

Subtracting twice the first row of  $\mathbf{A}_1$  from the third yields

$$\mathbf{A}_2 = \begin{bmatrix} 1 & 0 & 1 \\ 0 & 1 & 1 \\ 0 & 2 & -2 \end{bmatrix} = \widehat{\mathbf{E}}_2 \widehat{\mathbf{E}}_1 \mathbf{A},$$

where

$$\widehat{\mathbf{E}}_2 = \begin{bmatrix} 1 & 0 & 0 \\ 0 & 1 & 0 \\ -2 & 0 & 1 \end{bmatrix}.$$

Subtracting twice the second row of  $\mathbf{A}_2$  from the third yields

$$\mathbf{A}_3 = \begin{bmatrix} 1 & 0 & 1 \\ 0 & 1 & 1 \\ 0 & 0 & -4 \end{bmatrix} = \widehat{\mathbf{E}}_3 \widehat{\mathbf{E}}_2 \widehat{\mathbf{E}}_1 \mathbf{A},$$

where

$$\widehat{\mathbf{E}}_3 = \begin{bmatrix} 1 & 0 & 0 \\ 0 & 1 & 0 \\ 0 & -2 & 1 \end{bmatrix}.$$

Multiplying the third row of  $\mathbf{A}_3$  by  $-\frac{1}{4}$  yields

$$\mathbf{A}_4 = \begin{bmatrix} 1 & 0 & 1 \\ 0 & 1 & 1 \\ 0 & 0 & 1 \end{bmatrix} = \widehat{\mathbf{E}}_4 \widehat{\mathbf{A}}_3 \widehat{\mathbf{E}}_2 \widehat{\mathbf{E}}_1 \mathbf{A},$$

where

$$\widehat{\mathbf{E}}_4 = \begin{bmatrix} 1 & 0 & 0 \\ 0 & 1 & 0 \\ 0 & 0 & -\frac{1}{4} \end{bmatrix}.$$

Subtracting the third row of  $\mathbf{A}_4$  from the first yields

$$\mathbf{A}_5 = \begin{bmatrix} 1 & 0 & 0 \\ 0 & 1 & 1 \\ 0 & 0 & 1 \end{bmatrix} = \widehat{\mathbf{E}}_5 \widehat{\mathbf{A}}_4 \widehat{\mathbf{E}}_3 \widehat{\mathbf{E}}_2 \widehat{\mathbf{E}}_1 \mathbf{A},$$

where

$$\widehat{\mathbf{E}}_5 = \begin{bmatrix} 1 & 0 & -1 \\ 0 & 1 & 0 \\ 0 & 0 & 1 \end{bmatrix}.$$

Finally, subtracting the third row of  $\mathbf{A}_5$  from the second yields

$$\mathbf{I} = \widehat{\mathbf{E}}_6 \widehat{\mathbf{E}}_5 \widehat{\mathbf{E}}_4 \widehat{\mathbf{E}}_3 \widehat{\mathbf{E}}_2 \widehat{\mathbf{E}}_1 \mathbf{A}, \quad (7.3.11)$$

where

$$\widehat{\mathbf{E}}_6 = \begin{bmatrix} 1 & 0 & 0 \\ 0 & 1 & -1 \\ 0 & 0 & 1 \end{bmatrix}.$$

From (7.3.11) and Theorem 6.1.16,

$$\mathbf{A} = (\widehat{\mathbf{E}}_6 \widehat{\mathbf{E}}_5 \widehat{\mathbf{E}}_4 \widehat{\mathbf{E}}_3 \widehat{\mathbf{E}}_2 \widehat{\mathbf{E}}_1)^{-1} = \widehat{\mathbf{E}}_1^{-1} \widehat{\mathbf{E}}_2^{-1} \widehat{\mathbf{E}}_3^{-1} \widehat{\mathbf{E}}_4^{-1} \widehat{\mathbf{E}}_5^{-1} \widehat{\mathbf{E}}_6^{-1}.$$

Therefore,

$$\mathbf{A} = \mathbf{E}_6 \mathbf{E}_5 \mathbf{E}_4 \mathbf{E}_3 \mathbf{E}_2 \mathbf{E}_1,$$

where

$$\mathbf{E}_1 = \widehat{\mathbf{E}}_6^{-1} = \begin{bmatrix} 1 & 0 & 0 \\ 0 & 1 & 1 \\ 0 & 0 & 1 \end{bmatrix}, \quad \mathbf{E}_2 = \widehat{\mathbf{E}}_5^{-1} = \begin{bmatrix} 1 & 0 & 1 \\ 0 & 1 & 0 \\ 0 & 0 & 1 \end{bmatrix},$$

$$\mathbf{E}_3 = \widehat{\mathbf{A}}_4^{-1} = \begin{bmatrix} 1 & 0 & 0 \\ 0 & 1 & 0 \\ 0 & 0 & -4 \end{bmatrix}, \quad \mathbf{E}_4 = \widehat{\mathbf{E}}_3^{-1} = \begin{bmatrix} 1 & 0 & 0 \\ 0 & 1 & 0 \\ 0 & 2 & 1 \end{bmatrix},$$

$$\mathbf{E}_5 = \widehat{\mathbf{E}}_2^{-1} = \begin{bmatrix} 1 & 0 & 0 \\ 0 & 1 & 0 \\ 2 & 0 & 1 \end{bmatrix}, \quad \mathbf{E}_6 = \widehat{\mathbf{E}}_1^{-1} = \begin{bmatrix} 0 & 1 & 0 \\ 1 & 0 & 0 \\ 0 & 0 & 1 \end{bmatrix}$$

(Exercise 7.3.7(c)). ■

Lemma 7.3.6 and Theorem 6.1.7(c) imply that an arbitrary invertible linear transformation  $\mathbf{L} : \mathbb{R}^n \rightarrow \mathbb{R}^n$ , defined by

$$\mathbf{X} = \mathbf{L}(\mathbf{Y}) = \mathbf{A}\mathbf{Y}, \quad (7.3.12)$$

can be written as a composition

$$\mathbf{L} = \mathbf{L}_k \circ \mathbf{L}_{k-1} \circ \cdots \circ \mathbf{L}_1, \quad (7.3.13)$$

where

$$\mathbf{L}_i(\mathbf{Y}) = \mathbf{E}_i \mathbf{Y}, \quad 1 \leq i \leq k.$$

**Theorem 7.3.7** *If  $S$  is a compact Jordan measurable subset of  $\mathbb{R}^n$  and  $\mathbf{L} : \mathbb{R}^n \rightarrow \mathbb{R}^n$  is the invertible linear transformation  $\mathbf{X} = \mathbf{L}(\mathbf{Y}) = \mathbf{A}\mathbf{Y}$ , then*

$$V(\mathbf{L}(S)) = |\det(\mathbf{A})|V(S). \quad (7.3.14)$$

**Proof** Theorem 7.3.5 implies that  $\mathbf{L}(S)$  is Jordan measurable. If

$$V(\mathbf{L}(R)) = |\det(\mathbf{A})|V(R) \quad (7.3.15)$$

whenever  $R$  is a rectangle, then (7.3.14) holds if  $S$  is any compact Jordan measurable set. To see this, suppose that  $\epsilon > 0$ , let  $R$  be a rectangle containing  $S$ , and let  $P = \{R_1, R_2, \dots, R_k\}$  be a partition of  $R$  such that the upper and lower sums of  $\psi_S$  over  $P$  satisfy the inequality

$$S(P) - s(P) < \epsilon. \quad (7.3.16)$$

Let  $\mathcal{U}_1$  and  $\mathcal{U}_2$  be as in (7.3.2). From (7.3.3) and (7.3.4),

$$s(P) = \sum_{j \in \mathcal{U}_1} V(R_j) \leq V(S) \leq \sum_{j \in \mathcal{U}_1} V(R_j) + \sum_{j \in \mathcal{U}_2} V(R_j) = S(P). \quad (7.3.17)$$

Theorem 7.3.7 implies that  $\mathbf{L}(R_1), \mathbf{L}(R_2), \dots, \mathbf{L}(R_k)$  and  $\mathbf{L}(S)$  are all Jordan measurable. Since

$$\bigcup_{j \in \mathcal{U}_1} R_j \subset S \subset \bigcup_{j \in \mathcal{J}_1 \cup \mathcal{J}_2} R_j,$$

it follows that

$$L\left(\bigcup_{j \in \mathcal{U}_1} R_j\right) \subset L(S) \subset L\left(\bigcup_{j \in \mathcal{J}_1 \cup \mathcal{J}_2} R_j\right).$$

Since  $L$  is one-to-one on  $\mathbb{R}^n$ , this implies that

$$\sum_{j \in \mathcal{U}_1} V(\mathbf{L}(R_j)) \leq V(\mathbf{L}(S)) \leq \sum_{j \in \mathcal{U}_1} V(\mathbf{L}(R_j)) + \sum_{j \in \mathcal{U}_2} V(\mathbf{L}(R_j)). \quad (7.3.18)$$

If we assume that (7.3.15) holds whenever  $R$  is a rectangle, then

$$V(\mathbf{L}(R_j)) = |\det(\mathbf{A})|V(R_j), \quad 1 \leq j \leq k,$$

so (7.3.18) implies that

$$s(P) \leq \frac{V(\mathbf{L}(S))}{|\det(\mathbf{A})|} \leq S(P).$$

This, (7.3.16) and (7.3.17) imply that

$$\left| V(S) - \frac{V(\mathbf{L}(S))}{|\det(\mathbf{A})|} \right| < \epsilon;$$

hence, since  $\epsilon$  can be made arbitrarily small, (7.3.14) follows for any Jordan measurable set.

To complete the proof, we must verify (7.3.15) for every rectangle

$$R = [a_1, b_1] \times [a_2, b_2] \times \cdots \times [a_n, b_n] = I_1 \times I_2 \times \cdots \times I_n.$$

Suppose that  $\mathbf{A}$  in (7.3.12) is an elementary matrix; that is, let

$$\mathbf{X} = \mathbf{L}(\mathbf{Y}) = \mathbf{E}\mathbf{Y}.$$

CASE 1. If  $\mathbf{E}$  is obtained by interchanging the  $i$ th and  $j$ th rows of  $\mathbf{I}$ , then

$$x_r = \begin{cases} y_r & \text{if } r \neq i \text{ and } r \neq j; \\ y_j & \text{if } r = i; \\ y_i & \text{if } r = j. \end{cases}$$

Then  $\mathbf{L}(R)$  is the Cartesian product of  $I_1, I_2, \dots, I_n$  with  $I_i$  and  $I_j$  interchanged, so

$$V(\mathbf{L}(R)) = V(R) = |\det(\mathbf{E})|V(R)$$

since  $\det(\mathbf{E}) = -1$  in this case (Exercise 7.3.7(a)).

CASE 2. If  $\mathbf{E}$  is obtained by multiplying the  $r$ th row of  $\mathbf{I}$  by  $a$ , then

$$x_r = \begin{cases} y_r & \text{if } r \neq i, \\ ay_i & \text{if } r = i. \end{cases}$$

Then

$$\mathbf{L}(R) = I_1 \times \cdots \times I_{i-1} \times I'_i \times I_{i+1} \times \cdots \times I_n,$$

where  $I'_i$  is an interval with length equal to  $|a|$  times the length of  $I_i$ , so

$$V(\mathbf{L}(R)) = |a|V(R) = |\det(\mathbf{E})|V(R)$$

since  $\det(\mathbf{E}) = a$  in this case (Exercise 7.3.7(a)).

CASE 3. If  $\mathbf{E}$  is obtained by adding  $a$  times the  $j$ th row of  $\mathbf{I}$  to its  $i$ th row ( $j \neq i$ ), then

$$x_r = \begin{cases} y_r & \text{if } r \neq i; \\ y_i + ay_j & \text{if } r = i. \end{cases}$$

Then

$$\mathbf{L}(R) = \{(x_1, x_2, \dots, x_n) \mid a_i + ax_j \leq x_i \leq b_i + ax_j \text{ and } a_r \leq x_r \leq b_r \text{ if } r \neq i\},$$

which is a parallelogram if  $n = 2$  and a parallelepiped if  $n = 3$  (Figure 7.3.1). Now

$$V(\mathbf{L}(R)) = \int_{\mathbf{L}(R)} d\mathbf{X},$$

which we can evaluate as an iterated integral in which the first integration is with respect to  $x_i$ . For example, if  $i = 1$ , then

$$V(\mathbf{L}(R)) = \int_{a_n}^{b_n} dx_n \int_{a_{n-1}}^{b_{n-1}} dx_{n-1} \cdots \int_{a_2}^{b_2} dx_2 \int_{a_1+ax_j}^{b_1+ax_j} dx_1. \quad (7.3.19)$$

Since

$$\int_{a_1+ax_j}^{b_1+ax_j} dy_1 = \int_{a_1}^{b_1} dy_1,$$

(7.3.19) can be rewritten as

$$\begin{aligned} V(\mathbf{L}(R)) &= \int_{a_n}^{b_n} dx_n \int_{a_{n-1}}^{b_{n-1}} dx_{n-1} \cdots \int_{a_2}^{b_2} dx_2 \int_{a_1}^{b_1} dx_1 \\ &= (b_n - a_n)(b_{n-1} - a_{n-1}) \cdots (b_1 - a_1) = V(R). \end{aligned}$$

Hence,  $V(\mathbf{L}(R)) = |\det(\mathbf{E})|V(R)$ , since  $\det(\mathbf{E}) = 1$  in this case (Exercise 7.3.7(a)).

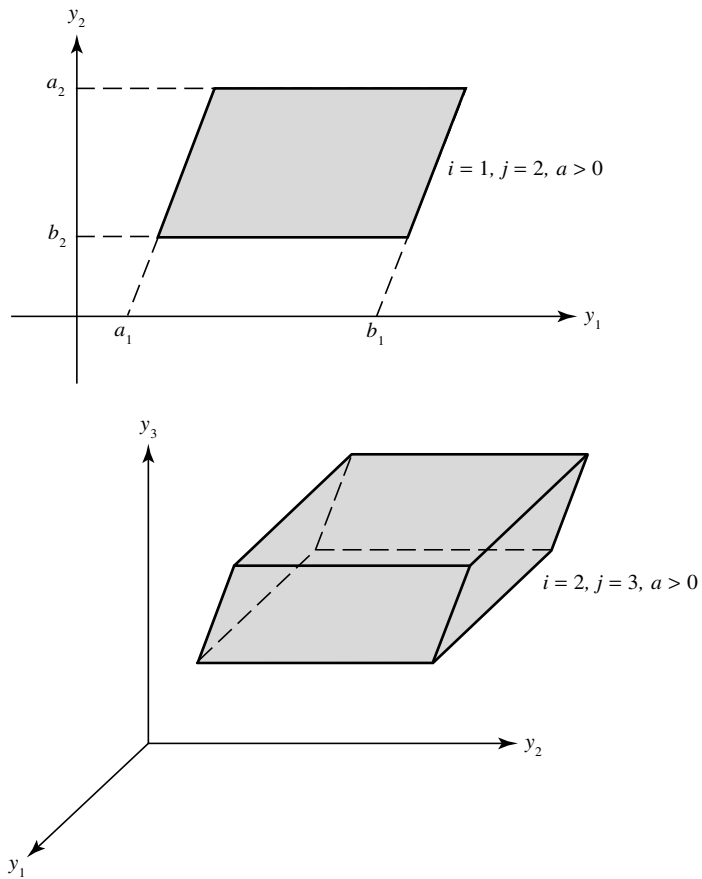


Figure 7.3.1

From what we have shown so far, (7.3.14) holds if  $\mathbf{A}$  is an elementary matrix and  $S$  is any compact Jordan measurable set. If  $\mathbf{A}$  is an arbitrary nonsingular matrix,

then we can write  $\mathbf{A}$  as a product of elementary matrices (7.3.10) and apply our known result successively to  $\mathbf{L}_1, \mathbf{L}_2, \dots, \mathbf{L}_k$  (see (7.3.13)). This yields

$$V(\mathbf{L}(S)) = |\det(\mathbf{E}_k)| |\det(\mathbf{E}_{k-1})| \cdots |\det \mathbf{E}_1| V(S) = |\det(\mathbf{A})| V(S),$$

by Theorem 6.1.9 and induction. ■

### Formulation of the Rule for Change of Variables

We now formulate the rule for change of variables in a multiple integral. Since we are for the present interested only in “discovering” the rule, we will make any assumptions that ease this task, deferring questions of rigor until the proof.

Throughout the rest of this section it will be convenient to think of the range and domain of a transformation  $\mathbf{G} : \mathbb{R}^n \rightarrow \mathbb{R}^n$  as subsets of distinct copies of  $\mathbb{R}^n$ . We will denote the copy containing  $D_G$  as  $\mathbb{E}^n$ , and write  $\mathbf{G} : \mathbb{E}^n \rightarrow \mathbb{R}^n$  and  $\mathbf{X} = \mathbf{G}(\mathbf{Y})$ , reversing the usual roles of  $\mathbf{X}$  and  $\mathbf{Y}$ .

If  $\mathbf{G}$  is regular on a subset  $S$  of  $\mathbb{E}^n$ , then each  $\mathbf{X}$  in  $\mathbf{G}(S)$  can be identified by specifying the unique point  $\mathbf{Y}$  in  $S$  such that  $\mathbf{X} = \mathbf{G}(\mathbf{Y})$ .

Suppose that we wish to evaluate  $\int_T f(\mathbf{X}) d\mathbf{X}$ , where  $T$  is the image of a compact Jordan measurable set  $S$  under the regular transformation  $\mathbf{X} = \mathbf{G}(\mathbf{Y})$ . For simplicity, we take  $S$  to be a rectangle and assume that  $f$  is continuous on  $T = \mathbf{G}(S)$ .

Now suppose that  $P = \{R_1, R_2, \dots, R_k\}$  is a partition of  $S$  and  $T_j = \mathbf{G}(R_j)$  (Figure 7.3.2).

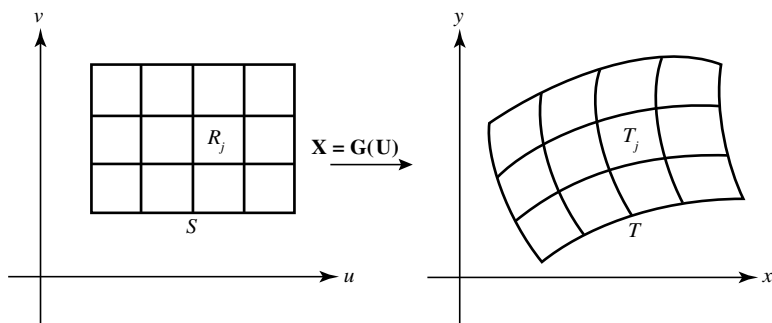


Figure 7.3.2

Then

$$\int_T f(\mathbf{X}) d\mathbf{X} = \sum_{j=1}^k \int_{T_j} f(\mathbf{X}) d\mathbf{X} \quad (7.3.20)$$

(Corollary 7.1.31 and induction). Since  $f$  is continuous, there is a point  $\mathbf{X}_j$  in  $T_j$  such that

$$\int_{T_j} f(\mathbf{X}) d\mathbf{X} = f(\mathbf{X}_j) \int_{T_j} d\mathbf{X} = f(\mathbf{X}_j) V(T_j)$$

(Theorem 7.1.28), so (7.3.20) can be rewritten as

$$\int_T f(\mathbf{X}) d\mathbf{X} = \sum_{j=1}^k f(\mathbf{X}_j) V(T_j). \quad (7.3.21)$$

Now we approximate  $V(T_j)$ . If

$$\mathbf{X}_j = \mathbf{G}(\mathbf{Y}_j), \quad (7.3.22)$$

then  $\mathbf{Y}_j \in R_j$  and, since  $\mathbf{G}$  is differentiable at  $\mathbf{Y}_j$ ,

$$\mathbf{G}(\mathbf{Y}) \approx \mathbf{G}(\mathbf{Y}_j) + \mathbf{G}'(\mathbf{Y}_j)(\mathbf{Y} - \mathbf{Y}_j). \quad (7.3.23)$$

Here  $\mathbf{G}$  and  $\mathbf{Y} - \mathbf{Y}_j$  are written as column matrices,  $\mathbf{G}'$  is a differential matrix, and “ $\approx$ ” means “approximately equal” in a sense that we could make precise if we wished (Theorem 6.2.2).

It is reasonable to expect that the Jordan content of  $\mathbf{G}(R_j)$  is approximately equal to the Jordan content of  $\mathbf{A}(R_j)$ , where  $\mathbf{A}$  is the affine transformation

$$\mathbf{A}(\mathbf{Y}) = \mathbf{G}(\mathbf{Y}_j) + \mathbf{G}'(\mathbf{Y}_j)(\mathbf{Y} - \mathbf{Y}_j)$$

on the right side of (7.3.23); that is,

$$V(\mathbf{G}(R_j)) \approx V(\mathbf{A}(R_j)). \quad (7.3.24)$$

We can think of the affine transformation  $\mathbf{A}$  as a composition  $\mathbf{A} = \mathbf{A}_3 \circ \mathbf{A}_2 \circ \mathbf{A}_1$ , where

$$\begin{aligned} \mathbf{A}_1(\mathbf{Y}) &= \mathbf{Y} - \mathbf{Y}_j, \\ \mathbf{A}_2(\mathbf{Y}) &= \mathbf{G}'(\mathbf{Y}_j)\mathbf{Y}, \end{aligned}$$

and

$$\mathbf{A}_3(\mathbf{Y}) = \mathbf{G}(\mathbf{Y}_j) + \mathbf{Y}.$$

Let  $R'_j = \mathbf{A}_1(R_j)$ . Since  $\mathbf{A}_1$  merely shifts  $R_j$  to a different location,  $R'_j$  is also a rectangle, and

$$V(R'_j) = V(R_j). \quad (7.3.25)$$

Now let  $R''_j = \mathbf{A}_2(R'_j)$ . (In general,  $R''_j$  is not a rectangle.) Since  $\mathbf{A}_2$  is the linear transformation with nonsingular matrix  $\mathbf{G}'(\mathbf{Y}_j)$ , Theorem 7.3.7 implies that

$$V(R''_j) = |\det \mathbf{G}'(\mathbf{Y}_j)| V(R'_j) = |J\mathbf{G}(\mathbf{Y}_j)| V(R_j), \quad (7.3.26)$$

where  $J\mathbf{G}$  is the Jacobian of  $\mathbf{G}$ . Now let  $R'''_j = \mathbf{A}_3(R''_j)$ . Since  $\mathbf{A}_3$  merely shifts all points in the same way,

$$V(R'''_j) = V(R''_j). \quad (7.3.27)$$

Now (7.3.24)–(7.3.27) suggest that

$$V(T_j) \approx |J\mathbf{G}(\mathbf{Y}_j)| V(R_j).$$



(Recall that  $T_j = \mathbf{G}(R_j)$ .) Substituting this and (7.3.22) into (7.3.21) yields

$$\int_T f(\mathbf{X}) d\mathbf{X} \approx \sum_{j=1}^k f(\mathbf{G}(\mathbf{Y}_j)) |J\mathbf{G}(\mathbf{Y}_j)| V(R_j).$$

But the sum on the right is a Riemann sum for the integral

$$\int_S f(\mathbf{G}(\mathbf{Y})) |J\mathbf{G}(\mathbf{Y})| d\mathbf{Y},$$

which suggests that

$$\int_T f(\mathbf{X}) d\mathbf{X} = \int_S f(\mathbf{G}(\mathbf{Y})) |J\mathbf{G}(\mathbf{Y})| d\mathbf{Y}.$$

We will prove this by an argument that was published in the *American Mathematical Monthly* [Vol. 61 (1954), pp. 81-85] by J. Schwartz.

### The Main Theorem

We now prove the following form of the rule for change of variable in a multiple integral.

**Theorem 7.3.8** *Suppose that  $\mathbf{G} : \mathbb{E}^n \rightarrow \mathbb{R}^n$  is regular on a compact Jordan measurable set  $S$  and  $f$  is continuous on  $\mathbf{G}(S)$ . Then*

$$\int_{\mathbf{G}(S)} f(\mathbf{X}) d\mathbf{X} = \int_S f(\mathbf{G}(\mathbf{Y})) |J\mathbf{G}(\mathbf{Y})| d\mathbf{Y}. \quad (7.3.28)$$

Since the proof is complicated, we break it down to a series of lemmas. We first observe that both integrals in (7.3.28) exist, by Corollary 7.3.2, since their integrands are continuous. (Note that  $S$  is compact and Jordan measurable by assumption, and  $\mathbf{G}(S)$  is compact and Jordan measurable by Theorem 7.3.5.) Also, the result is trivial if  $V(S) = 0$ , since then  $V(\mathbf{G}(S)) = 0$  by Lemma 7.3.4, and both integrals in (7.3.28) vanish. Hence, we assume that  $V(S) > 0$ . We need the following definition.

**Definition 7.3.9** If  $\mathbf{A} = [a_{ij}]$  is an  $n \times n$  matrix, then

$$\max \left\{ \sum_{j=1}^n |a_{ij}| \mid 1 \leq i \leq n \right\}$$

is the *infinity norm* of  $A$ , denoted by  $\|A\|_\infty$ .

**Lemma 7.3.10** *Suppose that  $\mathbf{G} : \mathbb{E}^n \rightarrow \mathbb{R}^n$  is regular on a cube  $C$  in  $\mathbb{E}^n$ , and let  $\mathbf{A}$  be a nonsingular  $n \times n$  matrix. Then*

$$V(\mathbf{G}(C)) \leq |\det(\mathbf{A})| \left[ \max \{ \|\mathbf{A}^{-1}\mathbf{G}'(\mathbf{Y})\|_\infty \mid \mathbf{Y} \in C \} \right]^n V(C). \quad (7.3.29)$$

**Proof** Let  $s$  be the edge length of  $C$ . Let  $\mathbf{Y}_0 = (c_1, c_2, \dots, c_n)$  be the center of  $C$ , and suppose that  $\mathbf{H} = (y_1, y_2, \dots, y_n) \in C$ . If  $\mathbf{H} = (h_1, h_2, \dots, h_n)$  is continuously differentiable on  $C$ , then applying the mean value theorem (Theorem 5.4.5) to the components of  $\mathbf{H}$  yields

$$h_i(\mathbf{Y}) - h_i(\mathbf{Y}_0) = \sum_{j=1}^n \frac{\partial h_i(\mathbf{Y}_i)}{\partial y_j} (y_j - c_j), \quad 1 \leq i \leq n,$$

where  $\mathbf{Y}_i \in C$ . Hence, recalling that

$$\mathbf{H}'(\mathbf{Y}) = \left[ \frac{\partial h_i}{\partial y_j} \right]_{i,j=1}^n,$$

applying Definition 7.3.9, and noting that  $|y_j - c_j| \leq s/2$ ,  $1 \leq j \leq n$ , we infer that

$$|h_i(\mathbf{Y}) - h_i(\mathbf{Y}_0)| \leq \frac{s}{2} \max \{ \|\mathbf{H}'(\mathbf{Y})\|_\infty \mid \mathbf{Y} \in C \}, \quad 1 \leq i \leq n.$$

This means that  $\mathbf{H}(C)$  is contained in a cube with center  $\mathbf{X}_0 = \mathbf{H}(\mathbf{Y}_0)$  and edge length

$$s \max \{ \|\mathbf{H}'(\mathbf{Y})\|_\infty \mid \mathbf{Y} \in C \}.$$

Therefore,

$$\begin{aligned} V(\mathbf{H}(C)) &\leq [\max \{ \|\mathbf{H}'(\mathbf{Y})\|_\infty \mid \mathbf{Y} \in C \}]^n s^n \\ &= [\max \{ \|\mathbf{H}'(\mathbf{Y})\|_\infty \mid \mathbf{Y} \in C \}]^n V(C). \end{aligned} \quad (7.3.30)$$

Now let

$$\mathbf{L}(\mathbf{X}) = \mathbf{A}^{-1}\mathbf{X}$$

and set  $\mathbf{H} = \mathbf{L} \circ \mathbf{G}$ ; then

$$\mathbf{H}(C) = \mathbf{L}(\mathbf{G}(C)) \quad \text{and} \quad \mathbf{H}' = \mathbf{A}^{-1}\mathbf{G}',$$

so (7.3.30) implies that

$$V(\mathbf{L}(\mathbf{G}(C))) \leq [\max \{ \|\mathbf{A}^{-1}\mathbf{G}'(\mathbf{Y})\|_\infty \mid \mathbf{Y} \in C \}]^n V(C). \quad (7.3.31)$$

Since  $\mathbf{L}$  is linear, Theorem 7.3.7 with  $\mathbf{A}$  replaced by  $\mathbf{A}^{-1}$  implies that

$$V(\mathbf{L}(\mathbf{G}(C))) = |\det(\mathbf{A})^{-1}| V(\mathbf{G}(C)).$$

This and (7.3.31) imply that

$$|\det(\mathbf{A}^{-1})| V(\mathbf{G}(C)) \leq [\max \{ \|\mathbf{A}^{-1}\mathbf{G}'(\mathbf{Y})\|_\infty \mid \mathbf{Y} \in C \}]^n V(C).$$

Since  $\det(\mathbf{A}^{-1}) = 1/\det(\mathbf{A})$ , this implies (7.3.29). ■

**Lemma 7.3.11** *If  $\mathbf{G} : \mathbb{E}^n \rightarrow \mathbb{R}^n$  is regular on a cube  $C$  in  $\mathbb{R}^n$ , then*

$$V(\mathbf{G}(C)) \leq \int_C |J\mathbf{G}(\mathbf{Y})| d\mathbf{Y}. \quad (7.3.32)$$

**Proof** Let  $P$  be a partition of  $C$  into subcubes  $C_1, C_2, \dots, C_k$  with centers  $\mathbf{Y}_1, \mathbf{Y}_2, \dots, \mathbf{Y}_k$ . Then

$$V(\mathbf{G}(C)) = \sum_{j=1}^k V(\mathbf{G}(C_j)). \quad (7.3.33)$$

Applying Lemma 7.3.10 to  $C_j$  with  $\mathbf{A} = \mathbf{G}'(\mathbf{A}_j)$  yields

$$V(\mathbf{G}(C_j)) \leq |J\mathbf{G}(\mathbf{Y}_j)| \left[ \max \{ \|(\mathbf{G}'(\mathbf{Y}_j))^{-1} \mathbf{G}'(\mathbf{Y})\|_\infty \mid \mathbf{Y} \in C_j \} \right]^n V(C_j). \quad (7.3.34)$$

Exercise 6.1.22 implies that if  $\epsilon > 0$ , there is a  $\delta > 0$  such that

$$\max \{ \|(\mathbf{G}'(\mathbf{Y}_j))^{-1} \mathbf{G}'(\mathbf{Y})\|_\infty \mid \mathbf{Y} \in C_j \} < 1 + \epsilon, \quad 1 \leq j \leq k, \quad \text{if } \|P\| < \delta.$$

Therefore, from (7.3.34),

$$V(\mathbf{G}(C_j)) \leq (1 + \epsilon)^n |J\mathbf{G}(\mathbf{Y}_j)| V(C_j),$$

so (7.3.33) implies that

$$V(\mathbf{G}(C)) \leq (1 + \epsilon)^n \sum_{j=1}^k |J\mathbf{G}(\mathbf{Y}_j)| V(C_j) \quad \text{if } \|P\| < \delta.$$

Since the sum on the right is a Riemann sum for  $\int_C |J\mathbf{G}(\mathbf{Y})| d\mathbf{Y}$  and  $\epsilon$  can be taken arbitrarily small, this implies (7.3.32). ■

**Lemma 7.3.12** Suppose that  $S$  is Jordan measurable and  $\epsilon, \rho > 0$ . Then there are cubes  $C_1, C_2, \dots, C_r$  in  $S$  with edge lengths  $< \rho$ , such that  $C_j \subset S$ ,  $1 \leq j \leq r$ ,  $C_i^0 \cap C_j^0 = \emptyset$  if  $i \neq j$ , and

$$V(S) \leq \sum_{j=1}^r V(C_j) + \epsilon. \quad (7.3.35)$$

**Proof** Since  $S$  is Jordan measurable,

$$\int_C \psi_S(\mathbf{X}) d\mathbf{X} = V(S)$$

if  $C$  is any cube containing  $S$ . From this and the definition of the integral, there is a  $\delta > 0$  such that if  $P$  is any partition of  $C$  with  $\|P\| < \delta$  and  $\sigma$  is any Riemann sum of  $\psi_S$  over  $P$ , then  $\sigma > V(S) - \epsilon/2$ . Therefore, if  $s(P)$  is the lower sum of  $\psi_S$  over  $\mathbf{P}$ , then

$$s(\mathbf{P}) > V(S) - \epsilon \quad \text{if } \|\mathbf{P}\| < \delta. \quad (7.3.36)$$

Now suppose that  $P = \{C_1, C_2, \dots, C_k\}$  is a partition of  $C$  into cubes with  $\|P\| < \min(\rho, \delta)$ , and let  $C_1, C_2, \dots, C_k$  be numbered so that  $C_j \subset S$  if  $1 \leq j \leq r$  and  $C_j \cap S^c \neq \emptyset$  if  $j > r$ . From (7.3.4),  $s(\mathbf{P}) = \sum_{j=1}^r V(C_j)$ . This and (7.3.36) imply (7.3.35). Clearly,  $C_i^0 \cap C_j^0 = \emptyset$  if  $i \neq j$ . ■

**Lemma 7.3.13** Suppose that  $\mathbf{G} : \mathbb{E}^n \rightarrow \mathbb{R}^n$  is regular on a compact Jordan measurable set  $S$  and  $f$  is continuous and nonnegative on  $\mathbf{G}(S)$ . Let

$$Q(S) = \int_{\mathbf{G}(S)} f(\mathbf{X}) d\mathbf{X} - \int_S f(\mathbf{G}(\mathbf{Y})) |J\mathbf{G}(\mathbf{Y})| d\mathbf{Y}. \quad (7.3.37)$$

Then  $Q(S) \leq 0$ .

**Proof** From the continuity of  $J\mathbf{G}$  and  $f$  on the compact sets  $S$  and  $\mathbf{G}(S)$ , there are constants  $M_1$  and  $M_2$  such that

$$|J\mathbf{G}(\mathbf{Y})| \leq M_1 \quad \text{if } \mathbf{Y} \in S \quad (7.3.38)$$

and

$$|f(\mathbf{X})| \leq M_2 \quad \text{if } \mathbf{X} \in \mathbf{G}(S) \quad (7.3.39)$$

(Theorem 5.2.11). Now suppose that  $\epsilon > 0$ . Since  $f \circ \mathbf{G}$  is uniformly continuous on  $S$  (Theorem 5.2.14), there is a  $\delta > 0$  such that

$$|f(\mathbf{G}(\mathbf{Y})) - f(\mathbf{G}(\mathbf{Y}'))| < \epsilon \quad \text{if } |\mathbf{Y} - \mathbf{Y}'| < \delta \text{ and } \mathbf{Y}, \mathbf{Y}' \in S. \quad (7.3.40)$$

Now let  $C_1, C_2, \dots, C_r$  be chosen as described in Lemma 7.3.12, with  $\rho = \delta/\sqrt{n}$ . Let

$$S_1 = \left\{ \mathbf{Y} \in S \mid \mathbf{Y} \notin \bigcup_{j=1}^r C_j \right\}.$$

Then  $V(S_1) < \epsilon$  and

$$S = \left( \bigcup_{j=1}^r C_j \right) \cup S_1. \quad (7.3.41)$$

Suppose that  $\mathbf{Y}_1, \mathbf{Y}_2, \dots, \mathbf{Y}_r$  are points in  $C_1, C_2, \dots, C_r$  and  $\mathbf{X}_j = \mathbf{G}(\mathbf{Y}_j)$ ,  $1 \leq j \leq r$ . From (7.3.41) and Theorem 7.1.30,

$$\begin{aligned} Q(S) &= \int_{\mathbf{G}(S_1)} f(\mathbf{X}) d\mathbf{X} - \int_{S_1} f(\mathbf{G}(\mathbf{Y})) |J\mathbf{G}(\mathbf{Y})| d\mathbf{Y} \\ &\quad + \sum_{j=1}^r \int_{\mathbf{G}(C_j)} f(\mathbf{X}) d\mathbf{X} - \sum_{j=1}^r \int_{C_j} f(\mathbf{G}(\mathbf{Y})) |J\mathbf{G}(\mathbf{Y})| d\mathbf{Y} \\ &= \int_{\mathbf{G}(S_1)} f(\mathbf{X}) d\mathbf{X} - \int_{S_1} f(\mathbf{G}(\mathbf{Y})) |J\mathbf{G}(\mathbf{Y})| d\mathbf{Y} \\ &\quad + \sum_{j=1}^r \int_{\mathbf{G}(C_j)} (f(\mathbf{X}) - f(\mathbf{A}_j)) d\mathbf{X} \\ &\quad + \sum_{j=1}^r \int_{C_j} ((f(\mathbf{G}(\mathbf{Y}_j)) - f(\mathbf{G}(\mathbf{Y}))) |J\mathbf{G}(\mathbf{Y})| d\mathbf{Y} \\ &\quad + \sum_{j=1}^r f(\mathbf{X}_j) \left( V(\mathbf{G}(C_j)) - \int_{C_j} |J\mathbf{G}(\mathbf{Y})| d\mathbf{Y} \right). \end{aligned}$$

Since  $f(\mathbf{X}) \geq 0$ ,

$$\int_{S_1} f(\mathbf{G}(\mathbf{Y}))|J\mathbf{G}(\mathbf{Y})| d\mathbf{Y} \geq 0,$$

and Lemma 7.3.11 implies that the last sum is nonpositive. Therefore,

$$Q(S) \leq I_1 + I_2 + I_3, \quad (7.3.42)$$

where

$$I_1 = \int_{\mathbf{G}(S_1)} f(\mathbf{X}) d\mathbf{X}, \quad I_2 = \sum_{j=1}^r \int_{\mathbf{G}(C_j)} |f(\mathbf{X}) - f(\mathbf{X}_j)| d\mathbf{X},$$

and

$$I_3 = \sum_{j=1}^r \int_{C_j} |f(\mathbf{G}(\mathbf{Y}_j)) - f(\mathbf{G}(\mathbf{Y}))||J\mathbf{G}(\mathbf{Y})| d\mathbf{Y}.$$

We will now estimate these three terms. Suppose that  $\epsilon > 0$ .

To estimate  $I_1$ , we first remind you that since  $\mathbf{G}$  is regular on the compact set  $S$ ,  $\mathbf{G}$  is also regular on some open set  $\mathcal{O}$  containing  $S$  (Definition 6.3.2). Therefore, since  $S_1 \subset S$  and  $V(S_1) < \epsilon$ ,  $S_1$  can be covered by cubes  $T_1, T_2, \dots, T_m$  such that

$$\sum_{j=1}^m V(T_j) < \epsilon \quad (7.3.43)$$

and  $\mathbf{G}$  is regular on  $\bigcup_{j=1}^m T_j$ . Now,

$$\begin{aligned} I_1 &\leq M_2 V(\mathbf{G}(S_1)) && \text{(from (7.3.39))} \\ &\leq M_2 \sum_{j=1}^m V(\mathbf{G}(T_j)) && \text{(since } S_1 \subset \bigcup_{j=1}^m T_j) \\ &\leq M_2 \sum_{j=1}^m \int_{T_j} |J\mathbf{G}(\mathbf{Y})| d\mathbf{Y} && \text{(from Lemma 7.3.11)} \\ &\leq M_2 M_1 \epsilon && \text{(from (7.3.38) and (7.3.43)).} \end{aligned}$$

To estimate  $I_2$ , we note that if  $\mathbf{X}$  and  $\mathbf{X}_j$  are in  $\mathbf{G}(C_j)$  then  $\mathbf{X} = \mathbf{G}(\mathbf{Y})$  and  $\mathbf{X}_j = \mathbf{G}(\mathbf{Y}_j)$  for some  $\mathbf{Y}$  and  $\mathbf{Y}_j$  in  $C_j$ . Since the edge length of  $C_j$  is less than  $\delta/\sqrt{n}$ , it follows that  $|\mathbf{Y} - \mathbf{Y}_j| < \delta$ , so  $|f(\mathbf{X}) - f(\mathbf{X}_j)| < \epsilon$ , by (7.3.40). Therefore,

$$\begin{aligned} I_2 &< \epsilon \sum_{j=1}^r V(\mathbf{G}(C_j)) \\ &\leq \epsilon \sum_{j=1}^r \int_{C_j} |J\mathbf{G}(\mathbf{Y})| d\mathbf{Y} && \text{(from Lemma 7.3.11)} \\ &\leq \epsilon M_1 \sum_{j=1}^r V(C_j) && \text{(from (7.3.38))} \\ &\leq \epsilon M_1 V(S) && \text{(since } \bigcup_{j=1}^r C_j \subset S). \end{aligned}$$

To estimate  $I_3$ , we note again from (7.3.40) that  $|f(\mathbf{G}(\mathbf{Y}_j)) - f(\mathbf{G}(\mathbf{Y}))| < \epsilon$  if  $\mathbf{Y}$  and  $\mathbf{Y}_j$  are in  $C_j$ . Hence,

$$\begin{aligned} I_3 &< \epsilon \sum_{j=1}^r \int_{C_j} |J\mathbf{G}(\mathbf{Y})| d\mathbf{Y} \\ &\leq M_1 \epsilon \sum_{j=1}^r V(C_j) \quad (\text{from (7.3.38)}) \\ &\leq M_1 V(S) \epsilon \end{aligned}$$

because  $\bigcup_{j=1}^r C_j \subset S$  and  $C_i^0 \cap C_j^0 = \emptyset$  if  $i \neq j$ .

From these inequalities on  $I_1$ ,  $I_2$ , and  $I_3$ , (7.3.42) now implies that

$$Q(S) < M_1(M_2 + 2V(S))\epsilon.$$

Since  $\epsilon$  is an arbitrary positive number, it now follows that  $Q(S) \leq 0$ . ■

**Lemma 7.3.14** *Under the assumptions of Lemma 7.3.13,  $Q(S) \geq 0$ .*

**Proof** Let

$$\mathbf{G}_1 = \mathbf{G}^{-1}, \quad S_1 = \mathbf{G}(S), \quad f_1 = (|J\mathbf{G}|)f \circ \mathbf{G}, \quad (7.3.44)$$

and

$$Q_1(S_1) = \int_{\mathbf{G}_1(S_1)} f_1(\mathbf{Y}) d\mathbf{Y} - \int_{S_1} f_1(\mathbf{G}_1(\mathbf{X})) |J\mathbf{G}_1(\mathbf{X})| d\mathbf{X}. \quad (7.3.45)$$

Since  $\mathbf{G}_1$  is regular on  $S_1$  (Theorem 6.3.3) and  $f_1$  is continuous and nonnegative on  $\mathbf{G}_1(S_1) = S$ , Lemma 7.3.13 implies that  $Q_1(S_1) \leq 0$ . However, substituting from (7.3.44) into (7.3.45) and again noting that  $\mathbf{G}_1(S_1) = S$  yields

$$\begin{aligned} Q_1(S_1) &= \int_S f(\mathbf{G}(\mathbf{Y})) |J\mathbf{G}(\mathbf{Y})| d\mathbf{Y} \\ &\quad - \int_{\mathbf{G}(S)} f(\mathbf{G}(\mathbf{G}^{-1}(\mathbf{X}))) |J\mathbf{G}(\mathbf{G}^{-1}(\mathbf{X}))| |J\mathbf{G}^{-1}(\mathbf{X})| d\mathbf{X}. \end{aligned} \quad (7.3.46)$$

Since  $\mathbf{G}(\mathbf{G}^{-1}(\mathbf{X})) = \mathbf{X}$ ,  $f(\mathbf{G}(\mathbf{G}^{-1}(\mathbf{X}))) = f(\mathbf{X})$ . However, it is important to interpret the symbol  $|J\mathbf{G}(\mathbf{G}^{-1}(\mathbf{X}))|$  properly. We are not substituting  $\mathbf{G}^{-1}(\mathbf{X})$  into  $\mathbf{G}$  here; rather, we are evaluating the determinant of the differential matrix of  $\mathbf{G}$  at the point  $\mathbf{Y} = \mathbf{G}^{-1}(\mathbf{X})$ . From Theorems 6.1.9 and 6.3.3,

$$|J\mathbf{G}(\mathbf{G}^{-1}(\mathbf{X}))| |J\mathbf{G}^{-1}(\mathbf{X})| = 1,$$

so (7.3.46) can be rewritten as

$$Q_1(S_1) = \int_S f(\mathbf{G}(\mathbf{Y})) |J\mathbf{G}(\mathbf{Y})| d\mathbf{Y} - \int_{\mathbf{G}(S)} f(\mathbf{X}) d\mathbf{X} = -Q(S).$$

Since  $Q_1(S_1) \leq 0$ , it now follows that  $Q(S) \geq 0$ . ■

We can now complete the proof of Theorem 7.3.8. Lemmas 7.3.13 and 7.3.14 imply (7.3.28) if  $f$  is nonnegative on  $S$ . Now suppose that

$$m = \min \{f(\mathbf{X}) \mid \mathbf{X} \in \mathbf{G}(S)\} < 0.$$

Then  $f - m$  is nonnegative on  $\mathbf{G}(S)$ , so (7.3.28) with  $f$  replaced by  $f - m$  implies that

$$\int_{\mathbf{G}(S)} (f(\mathbf{X}) - m) d\mathbf{X} = \int_S (f(\mathbf{G}(\mathbf{Y}) - m) |J\mathbf{G}(\mathbf{Y})| d\mathbf{Y}. \quad (7.3.47)$$

However, setting  $f = 1$  in (7.3.28) yields

$$\int_{\mathbf{G}(S)} d\mathbf{X} = \int_S |J\mathbf{G}(\mathbf{Y})| d\mathbf{Y},$$

so (7.3.47) implies (7.3.28). ■

The assumptions of Theorem 7.3.8 are too stringent for many applications. For example, to find the area of the disc

$$\{(x, y) \mid x^2 + y^2 \leq 1\},$$

it is convenient to use polar coordinates and regard the circle as  $\mathbf{G}(S)$ , where

$$\mathbf{G}(r, \theta) = \begin{bmatrix} r \cos \theta \\ r \sin \theta \end{bmatrix} \quad (7.3.48)$$

and  $S$  is the compact set

$$S = \{(r, \theta) \mid 0 \leq r \leq 1, 0 \leq \theta \leq 2\pi\} \quad (7.3.49)$$

(Figure 7.3.3).

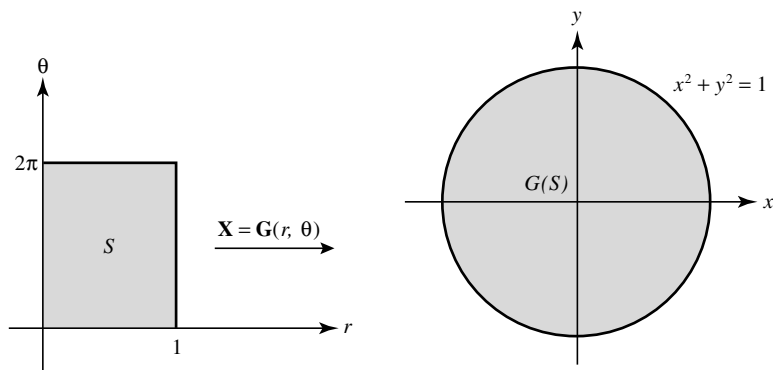


Figure 7.3.3

Since

$$\mathbf{G}'(r, \theta) = \begin{bmatrix} \cos \theta & -r \sin \theta \\ \sin \theta & r \cos \theta \end{bmatrix},$$

it follows that  $J\mathbf{G}(r, \theta) = r$ . Therefore, formally applying Theorem 7.3.8 with  $f \equiv 1$  yields

$$A = \int_{\mathbf{G}(S)} d\mathbf{X} = \int_S r d(r, \theta) = \int_0^1 r dr \int_0^{2\pi} d\theta = \pi.$$

Although this is a familiar result, Theorem 7.3.8 does not really apply here, since  $\mathbf{G}(r, 0) = \mathbf{G}(r, 2\pi)$ ,  $0 \leq r \leq 1$ , so  $\mathbf{G}$  is not one-to-one on  $S$ , and therefore not regular on  $S$ .

The next theorem shows that the assumptions of Theorem 7.3.8 can be relaxed so as to include this example.

**Theorem 7.3.15** *Suppose that  $\mathbf{G} : \mathbb{E}^n \rightarrow \mathbb{R}^n$  is continuously differentiable on a bounded open set  $N$  containing the compact Jordan measurable set  $S$ , and regular on  $S^0$ . Suppose also that  $\mathbf{G}(S)$  is Jordan measurable,  $f$  is continuous on  $\mathbf{G}(S)$ , and  $G(C)$  is Jordan measurable for every cube  $C \subset N$ . Then*

$$\int_{\mathbf{G}(S)} f(\mathbf{X}) d\mathbf{X} = \int_S f(\mathbf{G}(\mathbf{Y})) |J\mathbf{G}(\mathbf{Y})| d\mathbf{Y}. \quad (7.3.50)$$

**Proof** Since  $f$  is continuous on  $\mathbf{G}(S)$  and  $(|J\mathbf{G}|)f \circ \mathbf{G}$  is continuous on  $S$ , the integrals in (7.3.50) both exist, by Corollary 7.3.2. Now let

$$\rho = \text{dist}(\partial S, N^c)$$

(Exercise 5.1.25), and

$$P = \{\mathbf{Y} \mid \text{dist}(\mathbf{Y}, \partial S)\} \leq \frac{\rho}{2}.$$

Then  $P$  is a compact subset of  $N$  (Exercise 5.1.26) and  $\partial S \subset P^0$  (Figure 7.3.4).

Since  $S$  is Jordan measurable,  $V(\partial S) = 0$ , by Theorem 7.3.1. Therefore, if  $\epsilon > 0$ , we can choose cubes  $C_1, C_2, \dots, C_k$  in  $P^0$  such that

$$\partial S \subset \bigcup_{j=1}^k C_j^0 \quad (7.3.51)$$

and

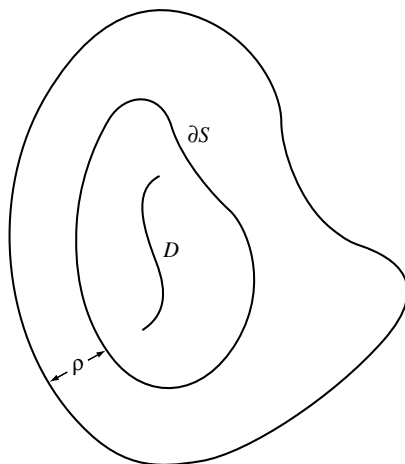
$$\sum_{j=1}^k V(C_j) < \epsilon \quad (7.3.52)$$

Now let  $S_1$  be the closure of the set of points in  $S$  that are not in any of the cubes  $C_1, C_2, \dots, C_k$ ; thus,

$$S_1 = \overline{S \cap \left( \bigcup_{j=1}^k C_j \right)^c}.$$



Because of (7.3.51),  $S_1 \cap \partial S = \emptyset$ , so  $S_1$  is a compact Jordan measurable subset of  $S^0$ . Therefore,  $\mathbf{G}$  is regular on  $S_1$ , and  $f$  is continuous on  $\mathbf{G}(S_1)$ . Consequently, if  $Q$  is as defined in (7.3.37), then  $Q(S_1) = 0$  by Theorem 7.3.8.



$N$  = open set bounded by outer curve  
 $S$  = closed set bounded by inner curve

**Figure 7.3.4**

Now

$$Q(S) = Q(S_1) + Q(S \cap S_1^c) = Q(S \cap S_1^c) \quad (7.3.53)$$

(Exercise 7.3.11) and

$$|Q(S \cap S_1^c)| \leq \left| \int_{\mathbf{G}(S \cap S_1^c)} f(\mathbf{X}) d\mathbf{X} \right| + \left| \int_{S \cap S_1^c} f(\mathbf{G}(\mathbf{Y})) |J\mathbf{G}(\mathbf{Y})| d\mathbf{Y} \right|.$$

But

$$\left| \int_{S \cap S_1^c} f(\mathbf{G}(\mathbf{Y})) |J\mathbf{G}(\mathbf{Y})| d\mathbf{Y} \right| \leq M_1 M_2 V(S \cap S_1^c), \quad (7.3.54)$$

where  $M_1$  and  $M_2$  are as defined in (7.3.38) and (7.3.39). Since  $S \cap S_1^c \subset \cup_{j=1}^k C_j$ , (7.3.52) implies that  $V(S \cap S_1^c) < \epsilon$ ; therefore,

$$\left| \int_{S \cap S_1^c} f(\mathbf{G}(\mathbf{Y})) |J\mathbf{G}(\mathbf{Y})| d\mathbf{Y} \right| \leq M_1 M_2 \epsilon, \quad (7.3.55)$$

from (7.3.54). Also

$$\left| \int_{\mathbf{G}(S \cap S_1^c)} f(\mathbf{X}) d\mathbf{X} \right| \leq M_2 V(\mathbf{G}(S \cap S_1^c)) \leq M_2 \sum_{j=1}^k V(\mathbf{G}(C_j)). \quad (7.3.56)$$

By the argument that led to (7.3.30) with  $H = G$  and  $C = C_j$ ,

$$V(\mathbf{G}(C_j)) \leq [\max \{\|\mathbf{G}'(\mathbf{Y})\|_\infty \mid \mathbf{Y} \in C_j\}]^n V(C_j),$$

so (7.3.56) can be rewritten as

$$\left| \int_{\mathbf{G}(S \cap S_1^c)} f(\mathbf{X}) d\mathbf{X} \right| \leq M_2 [\max \{\|\mathbf{G}'(\mathbf{Y})\|_\infty \mid \mathbf{Y} \in P\}]^n \epsilon,$$

because of (7.3.52). Since  $\epsilon$  can be made arbitrarily small, this and (7.3.55) imply that  $Q(S \cap S_1^c) = 0$ . Now  $Q(S) = 0$ , from (7.3.53). ■

The transformation to polar coordinates to compute the area of the disc is now justified, since  $\mathbf{G}$  and  $S$  as defined by (7.3.48) and (7.3.49) satisfy the assumptions of Theorem 7.3.15.

## Polar Coordinates

If  $\mathbf{G}$  is the transformation from polar to rectangle coordinates

$$\begin{bmatrix} x \\ y \end{bmatrix} = \mathbf{G}(r, \theta) = \begin{bmatrix} r \cos \theta \\ r \sin \theta \end{bmatrix}, \quad (7.3.57)$$

then  $J\mathbf{G}(r, \theta) = r$  and (7.3.50) becomes

$$\int_{\mathbf{G}(S)} f(x, y) d(x, y) = \int_S f(r \cos \theta, r \sin \theta) r d(r, \theta)$$

if we assume, as is conventional, that  $S$  is in the closed right half of the  $r\theta$ -plane. This transformation is especially useful when the boundaries of  $S$  can be expressed conveniently in terms of polar coordinates, as in the example preceding Theorem 7.3.15. Two more examples follow.

**Example 7.3.2** Evaluate

$$I = \int_T (x^2 + y) d(x, y),$$

where  $T$  is the annulus

$$T = \{(x, y) \mid 1 \leq x^2 + y^2 \leq 4\}$$

(Figure 7.3.5(b)).

**Solution** We write  $T = \mathbf{G}(S)$ , with  $\mathbf{G}$  as in (7.3.57) and

$$S = \{(r, \theta) \mid 1 \leq r \leq 2, 0 \leq \theta \leq 2\pi\}$$

(Figure 7.3.5(a)). Theorem 7.3.15 implies that

$$I = \int_S (r^2 \cos^2 \theta + r \sin \theta) r \, d(r, \theta),$$

which we evaluate as an iterated integral:

$$\begin{aligned} I &= \int_1^2 r^2 \, dr \int_0^{2\pi} (r \cos^2 \theta + \sin \theta) \, d\theta \\ &= \int_1^2 r^2 \, dr \int_0^{2\pi} \left( \frac{r}{2} + \frac{r}{2} \cos 2\theta + \sin \theta \right) \, d\theta \left[ \text{since } \cos^2 \theta = \frac{1}{2}(1 + \cos 2\theta) \right] \\ &= \int_1^2 r^2 \left[ \frac{r\theta}{2} + \frac{r}{4} \sin 2\theta - \cos \theta \right] \Big|_{\theta=0}^{2\pi} \, dr = \pi \int_1^2 r^3 \, dr = \frac{\pi r^4}{4} \Big|_1^2 = \frac{15\pi}{4}. \end{aligned}$$

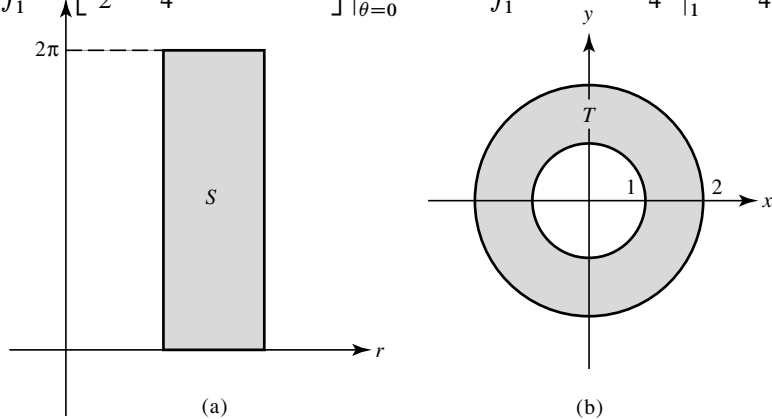


Figure 7.3.5

**Example 7.3.3** Evaluate

$$I = \int_T y \, d(x, y),$$

where  $T$  is the region in the  $xy$ -plane bounded by the curve whose points have polar coordinates satisfying

$$r = 1 - \cos \theta, \quad 0 \leq \theta \leq \pi$$

(Figure 7.3.6(b)).

**Solution** We write  $T = \mathbf{G}(S)$ , with  $\mathbf{G}$  as in (7.3.57) and  $S$  the shaded region in Figure 7.3.6(a). From (7.3.50),

$$I = \int_S (r \sin \theta) r \, d(r, \theta),$$

which we evaluate as an iterated integral:

$$\begin{aligned} I &= \int_0^\pi \sin \theta \, d\theta \int_0^{1-\cos \theta} r^2 \, dr = \frac{1}{3} \int_0^\pi (1 - \cos \theta)^3 \sin \theta \, d\theta \\ &= \frac{1}{12} (1 - \cos \theta)^4 \Big|_0^\pi = \frac{4}{3}. \end{aligned}$$

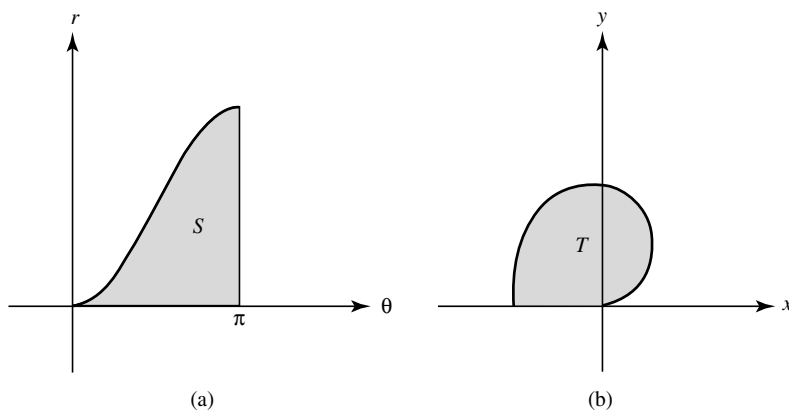


Figure 7.3.6

### Spherical Coordinates

If  $\mathbf{G}$  is the transformation from spherical to rectangular coordinates,

$$\begin{bmatrix} x \\ y \\ z \end{bmatrix} = \mathbf{G}(r, \theta, \phi) = \begin{bmatrix} r \cos \theta \cos \phi \\ r \sin \theta \cos \phi \\ r \sin \phi \end{bmatrix}, \quad (7.3.58)$$

then

$$\mathbf{G}'(r, \theta, \phi) = \begin{bmatrix} \cos \theta \cos \phi & -r \sin \theta \cos \phi & -r \cos \theta \sin \phi \\ \sin \theta \cos \phi & r \cos \theta \cos \phi & -r \sin \theta \sin \phi \\ \sin \phi & 0 & r \cos \phi \end{bmatrix}$$

and  $J\mathbf{G}(r, \theta, \phi) = r^2 \cos \phi$ , so (7.3.50) becomes

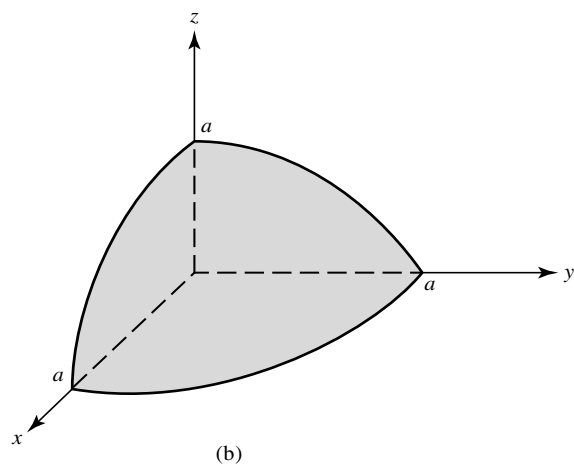
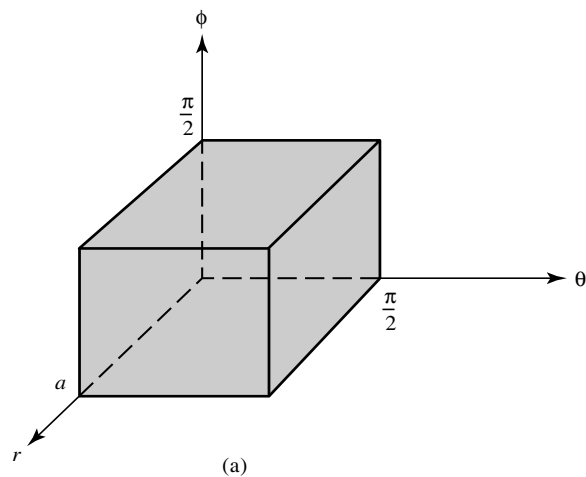
$$\begin{aligned} &\int_{\mathbf{G}(S)} f(x, y, z) \, d(x, y, z) \\ &= \int_S f(r \cos \theta \cos \phi, r \sin \theta \cos \phi, r \sin \phi) r^2 \cos \phi \, d(r, \theta, \phi) \end{aligned} \quad (7.3.59)$$

if we make the conventional assumption that  $|\phi| \leq \pi/2$  and  $r \geq 0$ .

**Example 7.3.4** Let  $a > 0$ . Find the volume of

$$T = \{(x, y, z) \mid x^2 + y^2 + z^2 \leq a^2, x \geq 0, y \geq 0, z \geq 0\},$$

which is one eighth of a sphere (Figure 7.3.7(b)).



**Figure 7.3.7**

**Solution** We write  $T = \mathbf{G}(S)$  with  $\mathbf{G}$  as in (7.3.58) and

$$S = \{(r, \theta, \phi) \mid 0 \leq r \leq a, 0 \leq \theta \leq \pi/2, 0 \leq \phi \leq \pi/2\}$$

(Figure 7.3.7(a)), and let  $f \equiv 1$  in (7.3.59). Theorem 7.3.15 implies that

$$\begin{aligned} V(T) &= \int_{\mathbf{G}(S)} d\mathbf{X} = \int_S r^2 \cos \phi \, d(r, \theta, \phi) \\ &= \int_0^a r^2 \, dr \int_0^{\pi/2} d\theta \int_0^{\pi/2} \cos \phi \, d\phi = \left(\frac{a^3}{3}\right) \left(\frac{\pi}{2}\right) (7.3.1) = \frac{\pi a^3}{6}. \end{aligned}$$

**Example 7.3.5** Evaluate the iterated integral

$$I = \int_0^a x \, dx \int_0^{\sqrt{a^2-x^2}} dy \int_0^{\sqrt{a^2-x^2-y^2}} z \, dz \quad (a > 0).$$

**Solution** We first rewrite  $I$  as a multiple integral

$$I = \int_{\mathbf{G}(S)} xz \, d(x, y, z)$$

where  $\mathbf{G}$  and  $S$  are as in Example 7.3.4. From Theorem 7.3.15,

$$\begin{aligned} I &= \int_S (r \cos \theta \cos \phi)(r \sin \phi)(r^2 \cos \phi) \, d(r, \theta, \phi) \\ &= \int_0^a r^4 \, dr \int_0^{\pi/2} \cos \theta \, d\theta \int_0^{\pi/2} \cos^2 \phi \sin \phi \, d\phi = \left(\frac{a^5}{5}\right) (7.3.1) \left(\frac{1}{3}\right) = \frac{a^5}{15}. \end{aligned}$$

### Other Examples

We now consider other applications of Theorem 7.3.15.

**Example 7.3.6** Evaluate

$$I = \int_T (x + 4y) \, d(x, y),$$

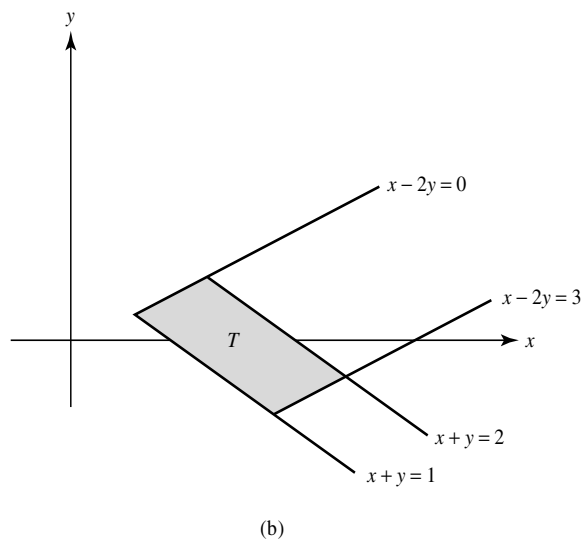
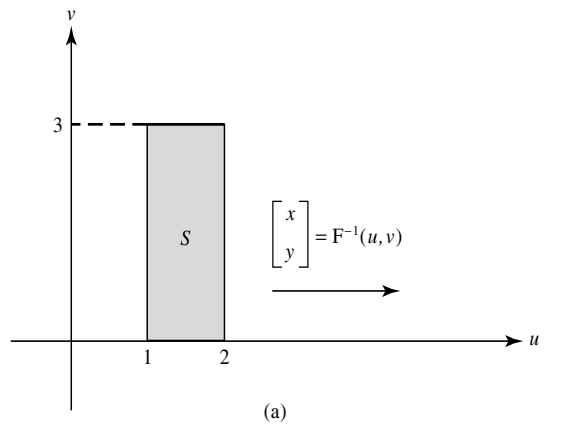
where  $T$  is the parallelogram bounded by the lines

$$x + y = 1, \quad x + y = 2, \quad x - 2y = 0, \quad \text{and} \quad x - 2y = 3$$

(Figure 7.3.8(b)).

**Solution** We define new variables  $u$  and  $v$  by

$$\begin{bmatrix} u \\ v \end{bmatrix} = \mathbf{F}(x, y) = \begin{bmatrix} x + y \\ x - 2y \end{bmatrix}.$$

**Figure 7.3.8**

Then

$$\begin{bmatrix} x \\ y \end{bmatrix} = \mathbf{F}^{-1}(u, v) = \begin{bmatrix} \frac{2u + v}{3} \\ \frac{u - v}{3} \end{bmatrix},$$

$$J\mathbf{F}^{-1}(u, v) = \begin{vmatrix} \frac{2}{3} & \frac{1}{3} \\ \frac{1}{3} & -\frac{1}{3} \end{vmatrix} = -\frac{1}{3},$$

and  $T = \mathbf{F}^{-1}(S)$ , where

$$S = \{(u, v) \mid 1 \leq u \leq 2, 0 \leq v \leq 3\}$$

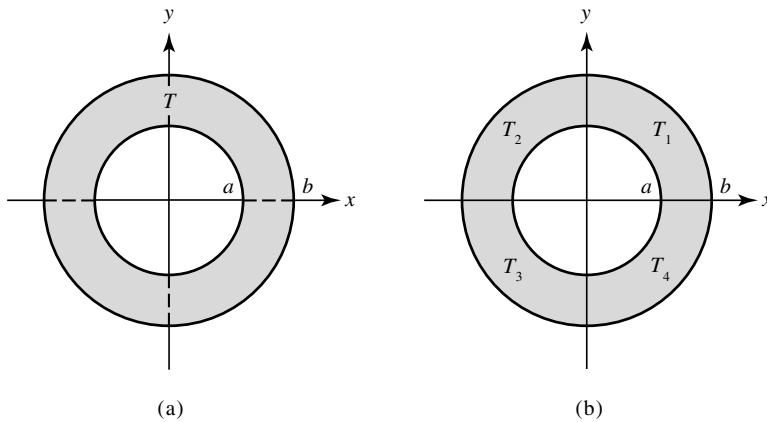
(Figure 7.3.8(a)). Applying Theorem 7.3.15 with  $\mathbf{G} = \mathbf{F}^{-1}$  yields

$$\begin{aligned} I &= \int_S \left( \frac{2u+v}{3} + \frac{4u-4v}{3} \right) \left( \frac{1}{3} \right) d(u, v) = \frac{1}{3} \int_S (2u-v) d(u, v) \\ &= \frac{1}{3} \int_0^3 dv \int_1^2 (2u-v) du = \frac{1}{3} \int_0^3 (u^2 - uv) \Big|_{u=1}^2 dv \\ &= \frac{1}{3} \int_0^3 (3-v) dv = \frac{1}{3} \left( 3v - \frac{v^2}{2} \right) \Big|_0^3 = \frac{3}{2}. \end{aligned}$$

**Example 7.3.7** Evaluate

$$I = \int_T e^{(x^2-y^2)^2} e^{4x^2y^2} (x^2 + y^2) d(x, y),$$

where  $T$  is the annulus  $T = \{(x, y) \mid a^2 \leq x^2 + y^2 \leq b^2\}$  with  $a > 0$  and  $b > 0$  (Figure 7.3.9(a)).



**Figure 7.3.9**

**Solution** The forms of the arguments of the exponential functions suggest that we introduce new variables  $u$  and  $v$  defined by

$$\begin{bmatrix} u \\ v \end{bmatrix} = \mathbf{F}(x, y) = \begin{bmatrix} x^2 - y^2 \\ 2xy \end{bmatrix}$$

and apply Theorem 7.3.15 to  $\mathbf{G} = \mathbf{F}^{-1}$ . However,  $\mathbf{F}$  is not one-to-one on  $T^0$  and therefore has no inverse on  $T^0$  (Example 6.3.4). To remove this difficulty, we regard  $T$  as the union of the quarter-annuli  $T_1$ ,  $T_2$ ,  $T_3$ , and  $T_4$  in the four quadrants (Figure 7.3.9(b)), and let

$$I_j = \int_{T_j} e^{(x^2-y^2)^2} e^{4x^2y^2} (x^2 + y^2) d(x, y).$$



Since the pairwise intersections of  $T_1$ ,  $T_2$ ,  $T_3$ , and  $T_4$  all have zero content,  $I = I_1 + I_2 + I_3 + I_4$  (Corollary 7.1.31). Theorem 7.3.8 implies that  $I_1 = I_2 = I_3 = I_4$  (Exercise 7.3.12), so  $I = 4I_1$ . Since  $I_1$  does not contain any pairs of distinct points of the form  $(x_0, y_0)$  and  $(-x_0, -y_0)$ ,  $\mathbf{F}$  is one-to-one on  $T_1$  (Example 6.3.4),

$$\mathbf{F}(T_1) = S_1 = \{(u, v) \mid a^4 \leq u^2 + v^2 \leq b^4, v \geq 0\}$$

(Figure 7.3.10(b)),

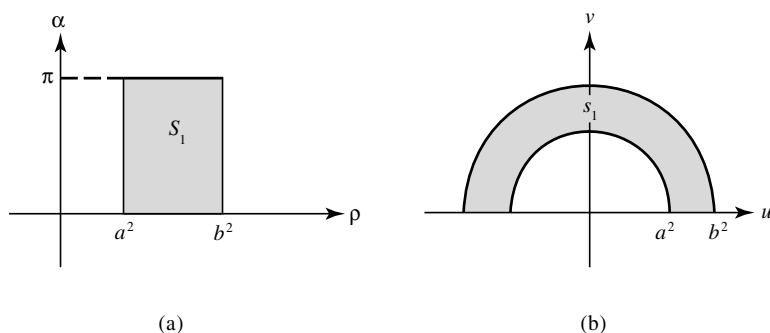


Figure 7.3.10

and a branch  $\mathbf{G}$  of  $\mathbf{F}^{-1}$  can be defined on  $S_1$  (Example 6.3.8). Now Theorem 7.3.15 implies that

$$I_1 = \int_{S_1} e^{(x^2-y^2)^2} e^{4x^2y^2} (x^2 + y^2) |J\mathbf{G}(u, v)| d(u, v),$$

where  $x$  and  $y$  must still be written in terms of  $u$  and  $v$ . Since it is easy to verify that

$$J\mathbf{F}(x, y) = 4(x^2 + y^2)$$

and therefore

$$J\mathbf{G}(u, v) = \frac{1}{4(x^2 + y^2)},$$

doing this yields

$$I_1 = \frac{1}{4} \int_{S_1} e^{u^2+v^2} d(u, v). \quad (7.3.60)$$

To evaluate this integral, we let  $\rho$  and  $\alpha$  be polar coordinates in the  $uv$ -plane (Figure 7.3.11) and define  $\mathbf{H}$  by

$$\begin{bmatrix} u \\ v \end{bmatrix} = \mathbf{H}(\rho, \alpha) = \begin{bmatrix} \rho \cos \alpha \\ \rho \sin \alpha \end{bmatrix};$$

then  $S_1 = \mathbf{H}(\tilde{S}_1)$ , where

$$\tilde{S}_1 = \{(\rho, \alpha) \mid a^2 \leq \rho \leq b^2, 0 \leq \alpha \leq \pi\}$$

(Figure 7.3.10(a)); hence, applying Theorem 7.3.15 to (7.3.60) yields

$$\begin{aligned} I_1 &= \frac{1}{4} \int_{\tilde{S}_1} e^{\rho^2} |J\mathbf{H}(\rho, \alpha)| d(\rho, \alpha) = \frac{1}{4} \int_{\tilde{S}_1} \rho e^{\rho^2} d(\rho, \alpha) \\ &= \frac{1}{4} \int_0^\pi d\alpha \int_{a^2}^{b^2} \rho e^{\rho^2} d\rho = \frac{\pi(e^{b^4} - e^{a^4})}{8}; \end{aligned}$$

hence,

$$I = 4I_1 = \frac{\pi}{2}(e^{b^4} - e^{a^4}).$$

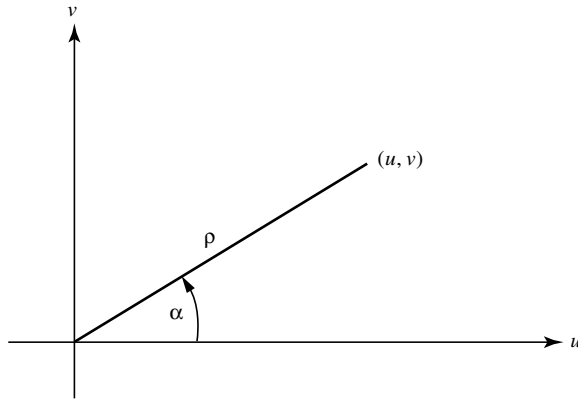


Figure 7.3.11

**Example 7.3.8** Evaluate

$$I = \int_T e^{x_1 + x_2 + \cdots + x_n} d(x_1, x_2, \dots, x_n),$$

where  $T$  is the region defined by

$$a_i \leq x_1 + x_2 + \cdots + x_i \leq b_i, \quad 1 \leq i \leq n.$$

**Solution** We define the new variables  $y_1, y_2, \dots, y_n$  by  $\mathbf{Y} = \mathbf{F}(\mathbf{X})$ , where

$$f_i(\mathbf{X}) = x_1 + x_2 + \cdots + x_i, \quad 1 \leq i \leq n.$$

If  $\mathbf{G} = \mathbf{F}^{-1}$  then  $T = \mathbf{G}(S)$ , where

$$S = [a_1, b_1] \times [a_2, b_2] \times \cdots \times [a_n, b_n],$$

and  $J\mathbf{G}(\mathbf{Y}) = 1$ , since  $J\mathbf{F}(\mathbf{X}) = 1$  (verify); hence, Theorem 7.3.8 implies that

$$\begin{aligned}
I &= \int_S e^{y_n} d(y_1, y_2, \dots, y_n) \\
&= \int_{a_1}^{b_1} dy_1 \int_{a_2}^{b_2} dy_2 \cdots \int_{a_{n-1}}^{b_{n-1}} dy_{n-1} \int_{a_n}^{b_n} e^{y_n} dy_n \\
&= (b_1 - a_1)(b_2 - a_2) \cdots (b_{n-1} - a_{n-1})(e^{b_n} - e^{a_n}).
\end{aligned}$$

### 7.3 Exercises

---

1. Give a counterexample to the following statement: If  $S_1$  and  $S_2$  are disjoint subsets of a rectangle  $R$ , then either

$$\overline{\int_R \psi_{S_1}(\mathbf{X}) d\mathbf{X}} + \overline{\int_R \psi_{S_2}(\mathbf{X}) d\mathbf{X}} = \overline{\int_R \psi_{S_1 \cup S_2}(\mathbf{X}) d\mathbf{X}}$$

or

$$\underline{\int_R \psi_{S_1}(\mathbf{X}) d\mathbf{X}} + \underline{\int_R \psi_{S_2}(\mathbf{X}) d\mathbf{X}} = \underline{\int_R \psi_{S_1 \cup S_2}(\mathbf{X}) d\mathbf{X}}.$$

2. Show that a set  $E$  has content zero according to Definition 7.1.14 if and only if  $E$  has Jordan content zero.
3. Show that if  $S_1$  and  $S_2$  are Jordan measurable, then so are  $S_1 \cup S_2$  and  $S_1 \cap S_2$ .
4. Prove:
- If  $S$  is Jordan measurable then so is  $\overline{S}$ , and  $V(\overline{S}) = V(S)$ . Must  $S$  be Jordan measurable if  $\overline{S}$  is?
  - If  $T$  is a Jordan measurable subset of a Jordan measurable set  $S$ , then  $S - T$  is Jordan measurable.
5. Suppose that  $H$  is a subset of a compact Jordan measurable set  $S$  such that the intersection of  $H$  with any compact subset of  $S^0$  has zero content. Show that  $V(H) = 0$ .
6. Suppose that  $\mathbf{E}$  is an  $n \times n$  elementary matrix and  $\mathbf{A}$  is an arbitrary  $n \times p$  matrix. Show that  $\mathbf{EA}$  is the matrix obtained by applying to  $\mathbf{A}$  the operation by which  $\mathbf{E}$  is obtained from the  $n \times n$  identity matrix.
7. (a) Calculate the determinants of elementary matrices of types (a), (b), and (c) of Lemma 7.3.6.
- (b) Show that the inverse of an elementary matrix of type (a), (b), or (c) is an elementary matrix of the same type.
- (c) Verify the inverses given for  $\widehat{\mathbf{E}}_1, \dots, \widehat{\mathbf{E}}_6$  in Example 7.3.1.

8. Write as a product of elementary matrices.

$$(a) \begin{bmatrix} 1 & 0 & 1 \\ 1 & 1 & 0 \\ 0 & 1 & 1 \end{bmatrix} \quad (b) \begin{bmatrix} 2 & 3 & -2 \\ 0 & -1 & 5 \\ 0 & -2 & 4 \end{bmatrix}$$

9. Suppose that  $ad - bc \neq 0$ ,  $u_1 < u_2$ , and  $v_1 < v_2$ . Find the area of the parallelogram bounded by the lines

$$\begin{aligned} ax + by &= u_1, & ax + by &= u_2, \\ cx + dy &= v_1, & cx + dy &= v_2. \end{aligned}$$

10. Find the volume of the parallelepiped defined by

$$1 \leq 2x + 3y - 2z \leq 2, \quad 5 \leq -x + 5y \leq 7, \quad 1 \leq -2x + 4y \leq 6.$$

11. In writing Eqn. (7.3.53) we assumed that

$$\int_{\mathbf{G}(S)} f(\mathbf{X}) d\mathbf{X} = \int_{\mathbf{G}(S_1)} f(\mathbf{X}) d\mathbf{X} + \int_{\mathbf{G}(S \cap S_1^c)} f(\mathbf{X}) d\mathbf{X}.$$

Justify this. HINT: Show that  $\mathbf{G}(S_1) \cap \mathbf{G}(S \cap S_1^c)$  has zero content.

12. Use Theorem 7.3.8 to show that  $I_1 = I_2 = I_3 = I_4$  in Example 7.3.7.

13. Let  $e_i = \pm 1$ ,  $0 \leq i \leq n$ . Let  $T$  be a bounded subset of  $\mathbb{R}^n$  and

$$\widehat{T} = \{(e_1x_1, e_2x_2, \dots, e_nx_n) \mid (x_1, x_2, \dots, x_n) \in T\}.$$

Suppose that  $f$  is defined on  $T$  and define  $g$  on  $\widehat{T}$  by

$$g(e_1x_1, e_2x_2, \dots, e_nx_n) = e_0 f(x_1, x_2, \dots, x_n).$$

- (a) Prove directly from Definitions 7.1.2 and 7.1.17 that  $f$  is integrable on  $T$  if and only if  $g$  is integrable on  $\widehat{T}$ , and in this case

$$\int_{\widehat{T}} g(\mathbf{Y}) d\mathbf{Y} = e_0 \int_T f(\mathbf{X}) d\mathbf{X}.$$

- (b) Suppose that  $\widehat{T} = T$ ,

$$f(e_1x_1, e_2x_2, \dots, e_nx_n) = -f(x_1, x_2, \dots, x_n),$$

and  $f$  is integrable on  $T$ . Show that

$$\int_T f(\mathbf{X}) d\mathbf{X} = 0.$$

14. Find the area of

(a)  $\{(x, y) \mid y \leq x \leq 4y, 1 \leq x + 2y \leq 3\}$ ;

(b)  $\{(x, y) \mid 2 \leq xy \leq 4, 2x \leq y \leq 5x\}$ .

15. Evaluate

$$\int_T (3x^2 + 2y + z) d(x, y, z),$$

where

$$T = \{(x, y, z) \mid |x - y| \leq 1, |y - z| \leq 1, |z + x| \leq 1\}.$$

16. Evaluate

$$\int_T (y^2 + x^2y - 2x^4) d(x, y),$$

where  $T$  is the region bounded by the curves

$$xy = 1, \quad xy = 2, \quad y = x^2, \quad y = x^2 + 1.$$

17. Evaluate

$$\int_T (x^4 - y^4)e^{xy} d(x, y),$$

where  $T$  is the region in the first quadrant bounded by the hyperbolas

$$xy = 1, \quad xy = 2, \quad x^2 - y^2 = 2, \quad x^2 - y^2 = 3.$$

18. Find the volume of the ellipsoid

$$\frac{x^2}{a^2} + \frac{y^2}{b^2} + \frac{z^2}{c^2} = 1 \quad (a, b, c > 0).$$

19. Evaluate

$$\int_T \frac{e^{x^2+y^2+z^2}}{\sqrt{x^2+y^2+z^2}} d(x, y, z),$$

where

$$T = \{(x, y, z) \mid 9 \leq x^2 + y^2 + z^2 \leq 25\}.$$

20. Find the volume of the set  $T$  bounded by the surfaces  $z = 0$ ,  $z = \sqrt{x^2 + y^2}$ , and  $x^2 + y^2 = 4$ .

21. Evaluate

$$\int_T xyz(x^4 - y^4) d(x, y, z),$$

where

$$T = \{(x, y, z) \mid 1 \leq x^2 - y^2 \leq 2, 3 \leq x^2 + y^2 \leq 4, 0 \leq z \leq 1\}.$$

22. Evaluate

$$\begin{aligned} \text{(a)} \quad & \int_0^{\sqrt{2}} dy \int_y^{\sqrt{4-y^2}} \frac{dx}{1+x^2+y^2} & \text{(b)} \quad & \int_0^2 dx \int_0^{\sqrt{4-x^2}} e^{x^2+y^2} dy \\ \text{(c)} \quad & \int_{-1}^1 dx \int_{-\sqrt{1-x^2}}^{\sqrt{1-x^2}} dy \int_0^{\sqrt{1-x^2-y^2}} z^2 dz \end{aligned}$$

23. Use the change of variables

$$\begin{bmatrix} x_1 \\ x_2 \\ x_3 \\ x_4 \end{bmatrix} = \mathbf{G}(r, \theta_1, \theta_2, \theta_3) = \begin{bmatrix} r \cos \theta_1 \cos \theta_2 \cos \theta_3 \\ r \sin \theta_1 \cos \theta_2 \cos \theta_3 \\ r \sin \theta_2 \cos \theta_3 \\ r \sin \theta_3 \end{bmatrix}$$

to compute the content of the 4-ball

$$T = \{(x_1, x_2, x_3, x_4) \mid x_1^2 + x_2^2 + x_3^2 + x_4^2 \leq a^2\}.$$

24. Suppose that  $\mathbf{A} = [a_{ij}]$  is a nonsingular  $n \times n$  matrix and  $T$  is the region in  $\mathbb{R}^n$  defined by

$$\alpha_i \leq a_{i1}x_1 + a_{i2}x_2 + \cdots + a_{in}x_n \leq \beta_i, \quad 1 \leq i \leq n.$$

- (a) Find  $V(T)$ .  
 (b) Show that if  $c_1, c_2, \dots, c_n$  are constants, then

$$\int_T \left( \sum_{j=1}^n c_j x_j \right) d\mathbf{X} = \frac{V(T)}{2} \sum_{i=1}^n d_i (\alpha_i + \beta_i),$$

where

$$\begin{bmatrix} d_1 \\ d_2 \\ \vdots \\ d_n \end{bmatrix} = (\mathbf{A}^t)^{-1} \begin{bmatrix} c_1 \\ c_2 \\ \vdots \\ c_n \end{bmatrix}.$$

25. If  $V_n$  is the content of the  $n$ -ball  $T = \{\mathbf{X} \mid |\mathbf{X}| \leq 1\}$ , find the content of the  $n$ -dimensional ellipsoid defined by

$$\sum_{j=1}^n \frac{x_j^2}{a_j^2} \leq 1.$$

Leave the answer in terms of  $V_n$ .

## CHAPTER 8

### Metric Spaces

IN THIS CHAPTER we study metric spaces.

SECTION 8.1 defines the concept and basic properties of a metric space. Several examples of metric spaces are considered.

SECTION 8.2 defines and discusses compactness in a metric space.

SECTION 8.3 deals with continuous functions on metric spaces.

#### 8.1 INTRODUCTION TO METRIC SPACES

**Definition 8.1.1** A *metric space* is a nonempty set  $A$  together with a real-valued function  $\rho$  defined on  $A \times A$  such that if  $u, v$ , and  $w$  are arbitrary members of  $A$ , then

- (a)  $\rho(u, v) \geq 0$ , with equality if and only if  $u = v$ ;
- (b)  $\rho(u, v) = \rho(v, u)$ ;
- (c)  $\rho(u, v) \leq \rho(u, w) + \rho(w, v)$ .

We say that  $\rho$  is a *metric* on  $A$ . ■

If  $n \geq 2$  and  $u_1, u_2, \dots, u_n$  are arbitrary members of  $A$ , then (c) and induction yield the inequality

$$\rho(u_1, u_n) \leq \sum_{i=1}^{n-1} \rho(u_i, u_{i+1}).$$

**Example 8.1.1** The set  $\mathbb{R}$  of real numbers with  $\rho(u, v) = |u - v|$  is a metric space. Definition 8.1.1(c) is the familiar triangle inequality:

$$|u - v| \leq |u - w| + |w - u|. \quad \blacksquare$$

Motivated by this example, in an arbitrary metric space we call  $\rho(u, v)$  the *distance from  $u$  to  $v$* , and we call Definition 8.1.1(c) the *triangle inequality*.

**Example 8.1.2** If  $A$  is an arbitrary nonempty set, then

$$\rho(u, v) = \begin{cases} 0 & \text{if } u = v, \\ 1 & \text{if } u \neq v \end{cases}$$

is a metric on  $A$  (Exercise 8.1.5). We call it the *discrete* metric. ■

Example 8.1.2 shows that it is possible to define a metric on any nonempty set  $A$ . In fact, it is possible to define infinitely many metrics on any set with more than one member (Exercise 8.1.3). Therefore, to specify a metric space completely, we must specify the couple  $(A, \rho)$ , where  $A$  is the set and  $\rho$  is the metric. (In some cases we will not be so precise; for example, we will always refer to the real numbers with the metric  $\rho(u, v) = |u - v|$  simply as  $\mathbb{R}$ .)

There is an important kind of metric space that arises when a definition of length is imposed on a vector space. Although we assume that you are familiar with the definition of a vector space, we restate it here for convenience. We confine the definition to vector spaces over the real numbers.

**Definition 8.1.2** A *vector space*  $A$  is a nonempty set of elements called *vectors* on which two operations, vector addition and scalar multiplication (multiplication by real numbers) are defined, such that the following assertions are true for all  $\mathbf{U}$ ,  $\mathbf{V}$ , and  $\mathbf{W}$  in  $A$  and all real numbers  $r$  and  $s$ :

1.  $\mathbf{U} + \mathbf{V} \in A$ ;
2.  $\mathbf{U} + \mathbf{V} = \mathbf{V} + \mathbf{U}$ ;
3.  $\mathbf{U} + (\mathbf{V} + \mathbf{W}) = (\mathbf{U} + \mathbf{V}) + \mathbf{W}$ ;
4. There is a vector  $\mathbf{0}$  in  $A$  such that  $\mathbf{U} + \mathbf{0} = \mathbf{U}$ ;
5. There is a vector  $-\mathbf{U}$  in  $A$  such that  $\mathbf{U} + (-\mathbf{U}) = \mathbf{0}$ ;
6.  $r\mathbf{U} \in A$ ;
7.  $r(\mathbf{U} + \mathbf{V}) = r\mathbf{U} + r\mathbf{V}$ ;
8.  $(r + s)\mathbf{U} = r\mathbf{U} + s\mathbf{U}$ ;
9.  $r(s\mathbf{U}) = (rs)\mathbf{U}$ ;
10.  $1\mathbf{U} = \mathbf{U}$ . ■

We say that  $A$  is *closed under vector addition* if (1) is true, and that  $A$  is *closed under scalar multiplication* if (6) is true. It can be shown that if  $B$  is any nonempty subset of  $A$  that is closed under vector addition and scalar multiplication, then  $B$  together with these operations is itself a vector space. (See any linear algebra text for the proof.) We say that  $B$  is a *subspace* of  $A$ .

**Definition 8.1.3** A *normed vector space* is a vector space  $A$  together with a real-valued function  $N$  defined on  $A$ , such that if  $u$  and  $v$  are arbitrary vectors in  $A$  and  $a$  is a real number, then

- (a)  $N(u) \geq 0$  with equality if and only if  $u = 0$ ;
- (b)  $N(au) = |a|N(u)$ ;
- (c)  $N(u + v) \leq N(u) + N(v)$ .

We say that  $N$  is a *norm* on  $A$ , and  $(A, N)$  is a *normed vector space*.



**Theorem 8.1.4** *If  $(A, N)$  is a normed vector space, then*

$$\rho(x, y) = N(x - y) \quad (8.1.1)$$

*is a metric on  $A$ .*

**Proof** From (a) with  $u = x - y$ ,  $\rho(x, y) = N(x - y) \geq 0$ , with equality if and only if  $x = y$ . From (b) with  $u = x - y$  and  $a = -1$ ,

$$\rho(y, x) = N(y - x) = N(-(x - y)) = N(x - y) = \rho(x, y).$$

From (c) with  $u = x - z$  and  $v = z - y$ ,

$$\rho(x, y) = N(x - y) \leq N(x - z) + N(z - y) = \rho(x, z) + \rho(z, y). \quad \blacksquare$$

We will say that the metric in (8.1.1) is *induced by the norm  $N$* . Whenever we speak of a normed vector space  $(A, N)$ , it is to be understood that we are regarding it as a metric space  $(A, \rho)$ , where  $\rho$  is the metric induced by  $N$ .

We will often write  $N(u)$  as  $\|u\|$ . In this case we will denote the normed vector space as  $(A, \|\cdot\|)$ .

**Theorem 8.1.5** *If  $x$  and  $y$  are vectors in a normed vector space  $(A, N)$ , then*

$$|N(x) - N(y)| \leq N(x - y). \quad (8.1.2)$$

**Proof** Since

$$x = y + (x - y),$$

Definition 8.1.3(c) with  $u = y$  and  $v = x - y$  implies that

$$N(x) \leq N(y) + N(x - y),$$

or

$$N(x) - N(y) \leq N(x - y).$$

Interchanging  $x$  and  $y$  yields

$$N(y) - N(x) \leq N(y - x).$$

Since  $N(x - y) = N(y - x)$  (Definition 8.1.3(b) with  $u = x - y$  and  $a = -1$ ), the last two inequalities imply (8.1.2).  $\blacksquare$

### Metrics for $\mathbb{R}^n$

In Section 5.1 we defined the norm of a vector  $\mathbf{X} = (x_1, x_2, \dots, x_n)$  in  $\mathbb{R}^n$  as

$$\|\mathbf{X}\| = \left( \sum_{i=1}^n x_i^2 \right)^{1/2}.$$

The metric induced by this norm is

$$\rho(\mathbf{X}, \mathbf{Y}) = \left( \sum_{i=1}^n (x_i - y_i)^2 \right)^{1/2}.$$

Whenever we write  $\mathbb{R}^n$  without identifying the norm or metric specifically, we are referring to  $\mathbb{R}^n$  with this norm and this induced metric.

The following definition provides infinitely many norms and metrics on  $\mathbb{R}^n$ .

**Definition 8.1.6** If  $p \geq 1$  and  $\mathbf{X} = (x_1, x_2, \dots, x_n)$ , let

$$\|\mathbf{X}\|_p = \left( \sum_{i=1}^n |x_i|^p \right)^{1/p}. \quad (8.1.3)$$

The metric induced on  $\mathbb{R}^n$  by this norm is

$$\rho_p(\mathbf{X}, \mathbf{Y}) = \left( \sum_{i=1}^n |x_i - y_i|^p \right)^{1/p}. \quad \blacksquare$$

To justify this definition, we must verify that (8.1.3) actually defines a norm. Since it is clear that  $\|\mathbf{X}\|_p \geq 0$  with equality if and only if  $\mathbf{X} = \mathbf{0}$ , and  $\|a\mathbf{X}\|_p = |a|\|\mathbf{X}\|_p$  if  $a$  is any real number and  $\mathbf{X} \in \mathbb{R}^n$ , this reduces to showing that

$$\|\mathbf{X} + \mathbf{Y}\|_p \leq \|\mathbf{X}\|_p + \|\mathbf{Y}\|_p \quad (8.1.4)$$

for every  $\mathbf{X}$  and  $\mathbf{Y}$  in  $\mathbb{R}^n$ . Since

$$|x_i + y_i| \leq |x_i| + |y_i|,$$

summing both sides of this equation from  $i = 1$  to  $n$  yields (8.1.4) with  $p = 1$ . To handle the case where  $p > 1$ , we need the following lemmas. The inequality established in the first lemma is known as *Hölder's inequality*.

**Lemma 8.1.7** Suppose that  $\mu_1, \mu_2, \dots, \mu_n$  and  $v_1, v_2, \dots, v_n$  are nonnegative numbers. Let  $p > 1$  and  $q = p/(p - 1)$ ; thus,

$$\frac{1}{p} + \frac{1}{q} = 1. \quad (8.1.5)$$

Then

$$\sum_{i=1}^n \mu_i v_i \leq \left( \sum_{i=1}^n \mu_i^p \right)^{1/p} \left( \sum_{i=1}^n v_i^q \right)^{1/q}. \quad (8.1.6)$$

**Proof** Let  $\alpha$  and  $\beta$  be any two positive numbers, and consider the function

$$f(\beta) = \frac{\alpha^p}{p} + \frac{\beta^q}{q} - \alpha\beta,$$

where we regard  $\alpha$  as a constant. Since  $f'(\beta) = \beta^{q-1} - \alpha$  and  $f''(\beta) = (q-1)\beta^{q-2} > 0$  for  $\beta > 0$ ,  $f$  assumes its minimum value on  $[0, \infty)$  at  $\beta = \alpha^{1/(q-1)} = \alpha^{p-1}$ . But

$$f(\alpha^{p-1}) = \frac{\alpha^p}{p} + \frac{\alpha^{(p-1)q}}{q} - \alpha^p = \alpha^p \left( \frac{1}{p} + \frac{1}{q} - 1 \right) = 0.$$

Therefore,

$$\alpha\beta \leq \frac{\alpha^p}{p} + \frac{\beta^q}{q} \quad \text{if } \alpha, \beta \geq 0. \quad (8.1.7)$$

Now let

$$\alpha_i = \mu_i \left( \sum_{j=1}^n \mu_j^p \right)^{-1/p} \quad \text{and} \quad \beta_i = v_i \left( \sum_{j=1}^n v_j^q \right)^{-1/q}.$$

From (8.1.7),

$$\alpha_i \beta_i \leq \frac{\mu_i^p}{p} \left( \sum_{j=1}^n \mu_j^p \right)^{-1} + \frac{v_i^q}{q} \left( \sum_{j=1}^n v_j^q \right)^{-1}.$$

From (8.1.5), summing this from  $i = 1$  to  $n$  yields  $\sum_{i=1}^n \alpha_i \beta_i \leq 1$ , which implies (8.1.6). ■

**Lemma 8.1.8 (Minkowski's Inequality)** Suppose that  $u_1, u_2, \dots, u_n$  and  $v_1, v_2, \dots, v_n$  are nonnegative numbers and  $p > 1$ . Then

$$\left( \sum_{i=1}^n (u_i + v_i)^p \right)^{1/p} \leq \left( \sum_{i=1}^n u_i^p \right)^{1/p} + \left( \sum_{i=1}^n v_i^p \right)^{1/p}. \quad (8.1.8)$$

**Proof** Again, let  $q = p/(p-1)$ . We write

$$\sum_{i=1}^n (u_i + v_i)^p = \sum_{i=1}^n u_i (u_i + v_i)^{p-1} + \sum_{i=1}^n v_i (u_i + v_i)^{p-1}. \quad (8.1.9)$$

From Hölder's inequality with  $\mu_i = u_i$  and  $v_i = (u_i + v_i)^{p-1}$ ,

$$\sum_{i=1}^n u_i (u_i + v_i)^{p-1} \leq \left( \sum_{i=1}^n u_i^p \right)^{1/p} \left( \sum_{i=1}^n (u_i + v_i)^p \right)^{1/q}, \quad (8.1.10)$$

since  $q(p-1) = p$ . Similarly,

$$\sum_{i=1}^n v_i (u_i + v_i)^{p-1} \leq \left( \sum_{i=1}^n v_i^p \right)^{1/p} \left( \sum_{i=1}^n (u_i + v_i)^p \right)^{1/q}.$$

This, (8.1.9), and (8.1.10) imply that

$$\sum_{i=1}^n (u_i + v_i)^p \leq \left[ \left( \sum_{i=1}^n u_i^p \right)^{1/p} + \left( \sum_{i=1}^n v_i^p \right)^{1/p} \right] \left( \sum_{i=1}^n (u_i + v_i)^p \right)^{1/q}.$$

Since  $1 - 1/q = 1/p$ , this implies (8.1.8), which is known as *Minkowski's inequality*. ■

We leave it to you to verify that Minkowski's inequality implies (8.1.4) if  $p > 1$ .

We now define the  $\infty$ -norm on  $\mathbb{R}^n$  by

$$\|\mathbf{X}\|_\infty = \max \{|x_i| \mid 1 \leq i \leq n\}. \quad (8.1.11)$$

We leave it to you to verify (Exercise 8.1.15) that  $\|\cdot\|_\infty$  is a norm on  $\mathbb{R}^n$ . The associated metric is

$$\rho_\infty(\mathbf{X}, \mathbf{Y}) = \max \{|x_i - y_i| \mid 1 \leq i \leq n\}.$$

The following theorem justifies the notation in (8.1.11).

**Theorem 8.1.9** *If  $\mathbf{X} \in \mathbb{R}^n$  and  $p_2 > p_1 \geq 1$ , then*

$$\|\mathbf{X}\|_{p_2} \leq \|\mathbf{X}\|_{p_1}; \quad (8.1.12)$$

moreover,

$$\lim_{p \rightarrow \infty} \|\mathbf{X}\|_p = \max \{|x_i| \mid 1 \leq i \leq n\}. \quad (8.1.13)$$

**Proof** Let  $u_1, u_2, \dots, u_n$  be nonnegative and  $M = \max \{u_i \mid 1 \leq i \leq n\}$ . Define

$$\sigma(p) = \left( \sum_{i=1}^n u_i^p \right)^{1/p}.$$

Since  $u_i/\sigma(p) \leq 1$  and  $p_2 > p_1$ ,

$$\left( \frac{u_i}{\sigma(p_2)} \right)^{p_1} \geq \left( \frac{u_i}{\sigma(p_2)} \right)^{p_2};$$

therefore,

$$\frac{\sigma(p_1)}{\sigma(p_2)} = \left( \sum_{i=1}^n \left( \frac{u_i}{\sigma(p_2)} \right)^{p_1} \right)^{1/p_1} \geq \left( \sum_{i=1}^n \left( \frac{u_i}{\sigma(p_2)} \right)^{p_2} \right)^{1/p_1} = 1,$$

so  $\sigma(p_1) \geq \sigma(p_2)$ . Since  $M \leq \sigma(p) \leq Mn^{1/p}$ ,  $\lim_{p \rightarrow \infty} \sigma(p) = M$ . Letting  $u_i = |x_i|$  yields (8.1.12) and (8.1.13). ■

Since Minkowski's inequality is false if  $p < 1$  (Exercise 8.1.19), (8.1.3) is not a norm in this case. However, if  $0 < p < 1$ , then

$$\|\mathbf{X}\|_p = \sum_{i=1}^n |x_i|^p$$

is a norm on  $\mathbb{R}^n$  (Exercise 8.1.20).

## Vector Spaces of Sequences of Real Numbers

In this section and in the exercises we will consider subsets of the vector space  $\mathbb{R}^\infty$  consisting of sequences  $\mathbf{X} = \{x_i\}_{i=1}^\infty$ , with vector addition and scalar multiplication defined by

$$\mathbf{X} + \mathbf{Y} = \{x_i + y_i\}_{i=1}^\infty \quad \text{and} \quad r\mathbf{X} = \{rx_i\}_{i=1}^\infty.$$

**Example 8.1.3** Suppose that  $1 < p < \infty$  and let

$$\ell_p = \left\{ \mathbf{X} \in \mathbb{R}^\infty \mid \sum_{i=1}^{\infty} |x_i|^p < \infty \right\}.$$

Let

$$\|\mathbf{X}\|_p = \left( \sum_{i=1}^{\infty} |x_i|^p \right)^{1/p}.$$

Show that  $(\ell_p, \|\cdot\|_p)$  is a normed vector space.

**Solution** Suppose that  $\mathbf{X}, \mathbf{Y} \in \ell_p$ . From Minkowski's inequality,

$$\left( \sum_{i=1}^n |x_i + y_i|^p \right)^{1/p} \leq \left( \sum_{i=1}^n |x_i|^p \right)^{1/p} + \left( \sum_{i=1}^n |y_i|^p \right)^{1/p}$$

for each  $n$ . Since the right side remains bounded as  $n \rightarrow \infty$ , so does the left, and

$$\left( \sum_{i=1}^{\infty} |x_i + y_i|^p \right)^{1/p} \leq \left( \sum_{i=1}^{\infty} |x_i|^p \right)^{1/p} + \left( \sum_{i=1}^{\infty} |y_i|^p \right)^{1/p}, \quad (8.1.14)$$

so  $\mathbf{X} + \mathbf{Y} \in \ell_p$ . Therefore,  $\ell_p$  is closed under vector addition. Since  $\ell_p$  is obviously closed under scalar multiplication,  $\ell_p$  is a vector space, and (8.1.14) implies that  $\|\cdot\|_p$  is a norm on  $\ell_p$ . ■

The metric induced by  $\|\cdot\|_p$  is

$$\rho_p(\mathbf{X}, \mathbf{Y}) = \left( \sum_{i=1}^{\infty} |x_i - y_i|^p \right)^{1/p}.$$

Henceforth, we will denote  $(\ell_p, \|\cdot\|_p)$  simply by  $\ell_p$ .

**Example 8.1.4** Let

$$\ell_\infty = \{ \mathbf{X} \in \mathbb{R}^\infty \mid \{x_i\}_{i=1}^\infty \text{ is bounded} \}.$$

Let

$$\|\mathbf{X}\|_\infty = \sup \{ |x_i| \mid i \geq 1 \}.$$

We leave it to you (Exercise 8.1.26) to show that  $(\ell_\infty, \|\cdot\|_\infty)$  is a normed vector space. ■

The metric induced by  $\|\cdot\|_\infty$  is

$$\rho_\infty(\mathbf{X}, \mathbf{Y}) = \sup \{ |x_i - y_i| \mid i \geq 1 \}.$$

Henceforth, we will denote  $(\ell_\infty, \|\cdot\|_\infty)$  simply by  $\ell_\infty$ .

### Familiar Definitions and Theorems

At this point you may want to review Definition 1.3.1 and Exercises 1.3.6 and 1.3.7, which apply equally well to subsets of a metric space  $(A, \rho)$ .

We will now state some definitions and theorems for a general metric space  $(A, \rho)$  that are analogous to definitions and theorems presented in Section 1.3 for the real numbers. To avoid repetition, it is to be understood in all these definitions that we are discussing a given metric space  $(A, \rho)$ .

**Definition 8.1.10** If  $u_0 \in A$  and  $\epsilon > 0$ , the set

$$N_\epsilon(u_0) = \{u \in A \mid \rho(u_0, u) < \epsilon\}$$

is called an  $\epsilon$ -neighborhood of  $u_0$ . (Sometimes we call  $S_\epsilon$  the *open ball of radius  $\epsilon$  centered at  $u_0$* .) If a subset  $S$  of  $A$  contains an  $\epsilon$ -neighborhood of  $u_0$ , then  $S$  is a *neighborhood* of  $u_0$ , and  $u_0$  is an *interior point* of  $S$ . The set of interior points of  $S$  is the *interior* of  $S$ , denoted by  $S^0$ . If every point of  $S$  is an interior point (that is,  $S^0 = S$ ), then  $S$  is *open*. A set  $S$  is *closed* if  $S^c$  is open.

**Example 8.1.5** Show that if  $r > 0$ , then the open ball

$$S_r(u_0) = \{u \in A \mid \rho(u_0, u) < r\}$$

is an open set.

**Solution** We must show that if  $u_1 \in S_r(u_0)$ , then there is an  $\epsilon > 0$  such that

$$S_\epsilon(u_1) \subset S_r(u_0). \quad (8.1.15)$$

If  $u_1 \in S_r(u_0)$ , then  $\rho(u_1, u_0) < r$ . Since

$$\rho(u, u_0) \leq \rho(u, u_1) + \rho(u_1, u_0)$$

for any  $u$  in  $A$ ,  $\rho(u, u_0) < r$  if  $\rho(u, u_1) < r - \rho(u_1, u_0)$ . Therefore, (8.1.15) holds if  $\epsilon < r - \rho(u_1, u_0)$ . ■

The entire space  $A$  is open and therefore  $\emptyset (= A^c)$  is closed. However,  $\emptyset$  is also open, for to deny this is to say that it contains a point that is not an interior point, which is absurd because  $\emptyset$  contains no points. Since  $\emptyset$  is open,  $A (= \emptyset^c)$  is closed. If  $A = \mathbb{R}$ , these are the only sets that are both open and closed, but this is not so in all metric spaces. For example, if  $\rho$  is the discrete metric, then every subset of  $A$  is both open and closed. (Verify!)

A *deleted neighborhood* of a point  $u_0$  is a set that contains every point of some neighborhood of  $u_0$  except  $u_0$  itself. (If  $\rho$  is the discrete metric then the empty set is a deleted neighborhood of every member of  $A$ !)

The proof of the following theorem is identical to the proof Theorem 1.3.3.

**Theorem 8.1.11**

- (a) *The union of open sets is open.*  
 (b) *The intersection of closed sets is closed.*

**Definition 8.1.12** Let  $S$  be a subset of  $A$ . Then

- (a)  $u_0$  is a *limit point* of  $S$  if every deleted neighborhood of  $u_0$  contains a point of  $S$ .  
 (b)  $u_0$  is a *boundary point* of  $S$  if every neighborhood of  $u_0$  contains at least one point in  $S$  and one not in  $S$ . The set of boundary points of  $S$  is the *boundary* of  $S$ , denoted by  $\partial S$ . The *closure* of  $S$ , denoted by  $\overline{S}$ , is defined by  $\overline{S} = S \cup \partial S$ .  
 (c)  $u_0$  is an *isolated point* of  $S$  if  $u_0 \in S$  and there is a neighborhood of  $u_0$  that contains no other point of  $S$ .  
 (d)  $u_0$  is *exterior* to  $S$  if  $u_0$  is in the interior of  $S^c$ . The collection of such points is the *exterior* of  $S$ . ■

Although this definition is identical to Definition 1.3.4, you should not assume that conclusions valid for the real numbers are necessarily valid in all metric spaces. For example, if  $A = \mathbb{R}$  and  $\rho(u, v) = |u - v|$ , then

$$\overline{S}_r(u_0) = \{u \mid \rho(u, u_0) \leq r\}.$$

This is not true in every metric space (Exercise 8.1.6).

For the proof of the following theorem, see the proofs of Theorem 1.3.5 and Corollary 1.3.6.

**Theorem 8.1.13** *A set is closed if and only if it contains all its limit points.*

## Completeness

Since metric spaces are not ordered, concepts and results concerning the real numbers that depend on order for their definitions must be redefined and reexamined in the context of metric spaces. The first example of this kind is completeness. To discuss this concept, we begin by defining an *infinite sequence* (more briefly, a *sequence*) in a metric space  $(A, \rho)$  as a function defined on the integers  $n \geq k$  with values in  $A$ . As we did for real sequences, we denote a sequence in  $A$  by, for example,  $\{u_n\} = \{u_n\}_{n=k}^{\infty}$ . A subsequence of a sequence in  $A$  is defined in exactly the same way as a subsequence of a sequence of real numbers (Definition 4.2.1).

**Definition 8.1.14** A sequence  $\{u_n\}$  in a metric space  $(A, \rho)$  *converges* to  $u \in A$  if

$$\lim_{n \rightarrow \infty} \rho(u_n, u) = 0. \quad (8.1.16)$$

In this case we say that  $\lim_{n \rightarrow \infty} u_n = u$ . ■

We leave the proof of the following theorem to you. (See the proofs of Theorems 4.1.2 and 4.2.2.)

**Theorem 8.1.15**

- (a) *The limit of a convergent sequence is unique.*  
 (b) *If  $\lim_{n \rightarrow \infty} u_n = u$ , then every subsequence of  $\{u_n\}$  converges to  $u$ .*

**Definition 8.1.16** A sequence  $\{u_n\}$  in a metric space  $(A, \rho)$  is a *Cauchy sequence* if for every  $\epsilon > 0$  there is an integer  $N$  such that

$$\rho(u_n, u_m) < \epsilon \quad \text{and} \quad m, n > N. \quad (8.1.17)$$

■

We note that if  $\rho$  is the metric induced by a norm  $\|\cdot\|$  on  $A$ , then (8.1.16) and (8.1.17) can be replaced by

$$\lim_{n \rightarrow \infty} \|u_n - u\| = 0$$

and

$$\|u_n - u_m\| < \epsilon \quad \text{and} \quad m, n > N,$$

respectively.

**Theorem 8.1.17** *If a sequence  $\{u_n\}$  in a metric space  $(A, \rho)$  is convergent, then it is a Cauchy sequence.*

**Proof** Suppose that  $\lim_{n \rightarrow \infty} u_n = u$ . If  $\epsilon > 0$ , there is an integer  $N$  such that  $\rho(u_n, u) < \epsilon/2$  if  $n > N$ . Therefore, if  $m, n > N$ , then

$$\rho(u_n, u_m) \leq \rho(u_n, u) + \rho(u, u_m) < \epsilon.$$

■

**Definition 8.1.18** A metric space  $(A, \rho)$  is *complete* if every Cauchy sequence in  $A$  has a limit.

**Example 8.1.6** Theorem 4.1.13 implies that the set  $\mathbb{R}$  of real numbers with  $\rho(u, v) = |u - v|$  is a complete metric space. ■

This example raises a question that we should resolve before going further. In Section 1.1 we defined completeness to mean that the real numbers have the following property:

Axiom (I). Every nonempty set of real numbers that is bounded above has a supremum.

Here we are saying that the real numbers are complete because every Cauchy sequence of real numbers has a limit. We will now show that these two usages of “complete” are consistent.



The proof of Theorem 4.1.13 requires the existence of the (finite) limits inferior and superior of a bounded sequence of real numbers, a consequence of Axiom (I). However, the assertion in Axiom (I) can be deduced as a theorem if Axiom (I) is replaced by the assumption that every Cauchy sequence of real numbers has a limit. To see this, let  $T$  be a nonempty set of real numbers that is bounded above. We first show that there are sequences  $\{u_i\}_{i=1}^{\infty}$  and  $\{v_i\}_{i=1}^{\infty}$  with the following properties for all  $i \geq 1$ :

- (a)  $u_i \leq t$  for some  $t \in T$  and  $v_i \geq t$  for all  $t \in T$ ;  
 (b)  $(v_i - u_i) \leq 2^{i-1}(v_1 - u_1)$ .  
 (c)  $u_i \leq u_{i+1} \leq v_{i+1} \leq v_i$

Since  $T$  is nonempty and bounded above,  $u_1$  and  $v_1$  can be chosen to satisfy (a) with  $i = 1$ . Clearly, (b) holds with  $i = 1$ . Let  $w_1 = (u_1 + v_1)/2$ , and let

$$(u_2, v_2) = \begin{cases} (w_1, v_1) & \text{if } w_1 \leq t \text{ for some } t \in T, \\ (u_1, w_1) & \text{if } w_1 \geq t \text{ for all } t \in T. \end{cases}$$

In either case, (a) and (b) hold with  $i = 2$  and (c) holds with  $i = 1$ . Now suppose that  $n > 1$  and  $\{u_1, \dots, u_n\}$  and  $\{v_1, \dots, v_n\}$  have been chosen so that (a) and (b) hold for  $1 \leq i \leq n$  and (c) holds for  $1 \leq i \leq n-1$ . Let  $w_n = (u_n + v_n)/2$  and let

$$(u_{n+1}, v_{n+1}) = \begin{cases} (w_n, v_n) & \text{if } w_n \leq t \text{ for some } t \in T, \\ (u_n, w_n) & \text{if } w_n \geq t \text{ for all } t \in T. \end{cases}$$

Then (a) and (b) hold for  $1 \leq i \leq n+1$  and (c) holds for  $1 \leq i \leq n$ . This completes the induction.

Now (b) and (c) imply that

$$0 \leq u_{i+1} - u_i \leq 2^{i-1}(v_1 - u_1) \quad \text{and} \quad 0 \leq v_i - v_{i+1} \leq 2^{i-1}(v_1 - u_1), \quad i \geq 1.$$

By an argument similar to the one used in Example 4.1.14, this implies that  $\{u_i\}_{i=1}^{\infty}$  and  $\{v_i\}_{i=1}^{\infty}$  are Cauchy sequences. Therefore the sequences both converge (because of our assumption), and (b) implies that they have the same limit. Let

$$\lim_{i \rightarrow \infty} u_i = \lim_{i \rightarrow \infty} v_i = \beta.$$

If  $t \in T$ , then  $v_i \geq t$  for all  $i$ , so  $\beta = \lim_{i \rightarrow \infty} v_i \geq t$ ; therefore,  $\beta$  is an upper bound of  $T$ . Now suppose that  $\epsilon > 0$ . Then there is an integer  $N$  such that  $u_N > \beta - \epsilon$ . From the definition of  $u_N$ , there is a  $t_N$  in  $T$  such that  $t_N \geq u_N > \beta - \epsilon$ . Therefore,  $\beta = \sup T$ . ■

**Example 8.1.7 (The Metric Space  $C[a, b]$ )** Let  $C[a, b]$  denote the set of all real-valued functions  $f$  continuous on the finite closed interval  $[a, b]$ . From Theorem 2.2.9, the quantity

$$\|f\| = \max \{|f(x)| \mid a \leq x \leq b\}$$

is well defined. We leave it to you to verify that it is a norm on  $C[a, b]$ . The metric induced by this norm is

$$\rho(f, g) = \|f - g\| = \max \{|f(x) - g(x)| \mid a \leq x \leq b\}.$$

Whenever we refer to  $C[a, b]$ , we mean this metric space or, equivalently, this normed linear space. ■

From Theorem 4.4.6, a Cauchy sequence  $\{f_n\}$  in  $C[a, b]$  converges uniformly to a function  $f$  on  $[a, b]$ , and Corollary 4.4.8 implies that  $f$  is in  $C[a, b]$ ; hence,  $C[a, b]$  is complete.

### The Principle of Nested Sets

We say that a sequence  $\{T_n\}$  of sets is *nested* if  $T_{n+1} \subset T_n$  for all  $n$ .

**Theorem 8.1.19 (The Principle of Nested Sets)** *A metric space  $(A, \rho)$  is complete if and only if every nested sequence  $\{T_n\}$  of nonempty closed subsets of  $A$  such that  $\lim_{n \rightarrow \infty} d(T_n) = 0$  has a nonempty intersection.*

**Proof** Suppose that  $(A, \rho)$  is complete and  $\{T_n\}$  is a nested sequence of nonempty closed subsets of  $A$  such that  $\lim_{n \rightarrow \infty} d(T_n) = 0$ . For each  $n$ , choose  $t_n \in T_n$ . If  $m \geq n$ , then  $t_m, t_n \in T_n$ , so  $\rho(t_n, t_m) < d(T_n)$ . Since  $\lim_{n \rightarrow \infty} d(T_n) = 0$ ,  $\{t_n\}$  is a Cauchy sequence. Therefore,  $\lim_{n \rightarrow \infty} t_n = \bar{t}$  exists. Since  $\bar{t}$  is a limit point of  $T_n$  and  $T_n$  is closed for all  $n$ ,  $\bar{t} \in T_n$  for all  $n$ . Therefore,  $\bar{t} \in \bigcap_{n=1}^{\infty} T_n$ ; in fact,  $\bigcap_{n=1}^{\infty} T_n = \{\bar{t}\}$ . (Why?)

Now suppose that  $(A, \rho)$  is not complete, and let  $\{t_n\}$  be a Cauchy sequence in  $A$  that does not have a limit. Choose  $n_1$  so that  $\rho(t_n, t_{n_1}) < 1/2$  if  $n \geq n_1$ , and let  $T_1 = \{t \mid \rho(t, t_{n_1}) \leq 1\}$ . Now suppose that  $j > 1$  and we have specified  $n_1, n_2, \dots, n_{j-1}$  and  $T_1, T_2, \dots, T_{j-1}$ . Choose  $n_j > n_{j-1}$  so that  $\rho(t_n, t_{n_j}) < 2^{-j}$  if  $n \geq n_j$ , and let  $T_j = \{t \mid \rho(t, t_{n_j}) \leq 2^{-j+1}\}$ . Then  $T_j$  is closed and nonempty,  $T_{j+1} \subset T_j$  for all  $j$ , and  $\lim_{j \rightarrow \infty} d(T_j) = 0$ . Moreover,  $t_n \in T_j$  if  $n \geq n_j$ . Therefore, if  $\bar{t} \in \bigcap_{j=1}^{\infty} T_j$ , then  $\rho(t_n, \bar{t}) < 2^{-j}$ ,  $n \geq n_j$ , so  $\lim_{n \rightarrow \infty} t_n = \bar{t}$ , contrary to our assumption. Hence,  $\bigcap_{j=1}^{\infty} T_j = \emptyset$ .

### Equivalent Metrics

When considering more than one metric on a given set  $A$  we must be careful, for example, in saying that a set is open, or that a sequence converges, etc., since the truth or falsity of the statement will in general depend on the metric as well as the set on which it is imposed. In this situation we will always refer to the metric space by its "full name;" that is,  $(A, \rho)$  rather than just  $A$ .

**Definition 8.1.20** If  $\rho$  and  $\sigma$  are both metrics on a set  $A$ , then  $\rho$  and  $\sigma$  are *equivalent* if there are positive constants  $\alpha$  and  $\beta$  such that

$$\alpha \leq \frac{\rho(x, y)}{\sigma(x, y)} \leq \beta \quad \text{for all } x, y \in A \quad \text{such that } x \neq y. \quad (8.1.18)$$

**Theorem 8.1.21** *If  $\rho$  and  $\sigma$  are equivalent metrics on a set  $A$ , then  $(A, \rho)$  and  $(A, \sigma)$  have the same open sets.*

**Proof** Suppose that (8.1.18) holds. Let  $S$  be an open set in  $(A, \rho)$  and let  $x_0 \in S$ . Then there is an  $\epsilon > 0$  such that  $x \in S$  if  $\rho(x, x_0) < \epsilon$ , so the second inequality in (8.1.18) implies that  $x_0 \in S$  if  $\sigma(x, x_0) \leq \epsilon/\beta$ . Therefore,  $S$  is open in  $(A, \sigma)$ .

Conversely, suppose that  $S$  is open in  $(A, \sigma)$  and let  $x_0 \in S$ . Then there is an  $\epsilon > 0$  such that  $x \in S$  if  $\sigma(x, x_0) < \epsilon$ , so the first inequality in (8.1.18) implies that  $x_0 \in S$  if  $\rho(x, x_0) \leq \epsilon\alpha$ . Therefore,  $S$  is open in  $(A, \rho)$ . ■

**Theorem 8.1.22** Any two norms  $N_1$  and  $N_2$  on  $\mathbb{R}^n$  induce equivalent metrics on  $\mathbb{R}^n$ .

**Proof** It suffices to show that there are positive constants  $\alpha$  and  $\beta$  such

$$\alpha \leq \frac{N_1(\mathbf{X})}{N_2(\mathbf{X})} \leq \beta \quad \text{if } \mathbf{X} \neq \mathbf{0}. \quad (8.1.19)$$

We will show that if  $N$  is any norm on  $\mathbb{R}^n$ , there are positive constants  $a_N$  and  $b_N$  such that

$$a_N \|\mathbf{X}\|_2 \leq N(\mathbf{X}) \leq b_N \|\mathbf{X}\|_2 \quad \text{if } \mathbf{X} \neq \mathbf{0} \quad (8.1.20)$$

and leave it to you to verify that this implies (8.1.19) with  $\alpha = a_{N_1}/b_{N_2}$  and  $\beta = b_{N_1}/a_{N_2}$ .

We write  $\mathbf{X} - \mathbf{Y} = (x_1, x_2, \dots, x_n)$  as

$$\mathbf{X} - \mathbf{Y} = \sum_{i=1}^n (x_i - y_i) \mathbf{E}_i,$$

where  $\mathbf{E}_i$  is the vector with  $i$ th component equal to 1 and all other components equal to 0. From Definition 8.1.3(b), (c), and induction,

$$N(\mathbf{X} - \mathbf{Y}) \leq \sum_{i=1}^n |x_i - y_i| N(\mathbf{E}_i);$$

therefore, by Schwarz's inequality,

$$N(\mathbf{X} - \mathbf{Y}) \leq K \|\mathbf{X} - \mathbf{Y}\|_2, \quad (8.1.21)$$

where

$$K = \left( \sum_{i=1}^n N^2(\mathbf{E}_i) \right)^{1/2}.$$

From (8.1.21) and Theorem 8.1.5,

$$|N(\mathbf{X}) - N(\mathbf{Y})| \leq K \|\mathbf{X} - \mathbf{Y}\|_2,$$

so  $N$  is continuous on  $\mathbb{R}_2^n = \mathbb{R}^n$ . By Theorem 5.2.12, there are vectors  $\mathbf{U}_1$  and  $\mathbf{U}_2$  such that  $\|\mathbf{U}_1\|_2 = \|\mathbf{U}_2\|_2 = 1$ ,

$$N(\mathbf{U}_1) = \min \{N(\mathbf{U}) \mid \|\mathbf{U}\|_2 = 1\}, \quad \text{and} \quad N(\mathbf{U}_2) = \max \{N(\mathbf{U}) \mid \|\mathbf{U}\|_2 = 1\}.$$

If  $a_N = N(\mathbf{U}_1)$  and  $b_N = N(\mathbf{U}_2)$ , then  $a_N$  and  $b_N$  are positive (Definition 8.1.3(a)), and

$$a_N \leq N\left(\frac{\mathbf{X}}{\|\mathbf{X}\|_2}\right) \leq b_N \quad \text{if } \mathbf{X} \neq \mathbf{0}.$$

This and Definition 8.1.3(b) imply (8.1.20). ■

We leave the proof of the following theorem to you.

**Theorem 8.1.23** Suppose that  $\rho$  and  $\sigma$  are equivalent metrics on  $A$ . Then

- (a) A sequence  $\{u_n\}$  converges to  $u$  in  $(A, \rho)$  if and only if it converges to  $u$  in  $(A, \sigma)$ .
- (b) A sequence  $\{u_n\}$  is a Cauchy sequence in  $(A, \rho)$  if and only if it is a Cauchy sequence in  $(A, \sigma)$ .
- (c)  $(A, \rho)$  is complete if and only if  $(A, \sigma)$  is complete.

### 8.1 Exercises

---

1. Show that (a), (b), and (c) of Definition 8.1.1 are equivalent to

- (i)  $\rho(u, v) = 0$  if and only if  $u = v$ ;
- (ii)  $\rho(u, v) \leq \rho(w, u) + \rho(w, v)$ .

2. Prove: If  $x, y, u,$  and  $v$  are arbitrary members of a metric space  $(A, \rho)$ , then

$$|\rho(x, y) - \rho(u, v)| \leq \rho(x, u) + \rho(v, y).$$

3. (a) Suppose that  $(A, \rho)$  is a metric space, and define

$$\rho_1(u, v) = \frac{\rho(u, v)}{1 + \rho(u, v)}.$$

Show that  $(A, \rho_1)$  is a metric space.

- (b) Show that infinitely many metrics can be defined on any set  $A$  with more than one member.
4. Let  $(A, \rho)$  be a metric space, and let

$$\sigma(u, v) = \frac{\rho(u, v)}{1 + \rho(u, v)}.$$

Show that a subset of  $A$  is open in  $(A, \rho)$  if and only if it is open in  $(A, \sigma)$ .

5. Show that if  $A$  is an arbitrary nonempty set, then

$$\rho(u, v) = \begin{cases} 0 & \text{if } v = u, \\ 1 & \text{if } v \neq u, \end{cases}$$

is a metric on  $A$ .

6. Suppose that  $(A, \rho)$  is a metric space,  $u_0 \in A$ , and  $r > 0$ .

- (a) Show that  $\bar{S}_r(u_0) \subset \{u \mid \rho(u, u_0) \leq r\}$  if  $A$  contains more than one point.
- (b) Verify that if  $\rho$  is the discrete metric, then  $\bar{S}_1(u_0) \neq \{u \mid \rho(u, u_0) \leq 1\}$ .

7. Prove:
- (a) The intersection of finitely many open sets is open.
  - (b) The union of finitely many closed sets is closed.
8. Prove:
- (a) If  $U$  is a neighborhood of  $u_0$  and  $U \subset V$ , then  $V$  is a neighborhood of  $u_0$ .
  - (b) If  $U_1, U_2, \dots, U_n$  are neighborhoods of  $u_0$ , so is  $\bigcap_{i=1}^n U_i$ .
9. Prove: A limit point of a set  $S$  is either an interior point or a boundary point of  $S$ .
10. Prove: An isolated point of  $S$  is a boundary point of  $S^c$ .
11. Prove:
- (a) A boundary point of a set  $S$  is either a limit point or an isolated point of  $S$ .
  - (b) A set  $S$  is closed if and only if  $S = \bar{S}$ .
12. Let  $S$  be an arbitrary set. Prove: (a)  $\partial S$  is closed. (b)  $S^0$  is open. (c) The exterior of  $S$  is open. (d) The limit points of  $S$  form a closed set. (e)  $\overline{\bar{S}} = \bar{S}$ .
13. Prove:
- (a)  $(S_1 \cap S_2)^0 = S_1^0 \cap S_2^0$
  - (b)  $S_1^0 \cup S_2^0 \subset (S_1 \cup S_2)^0$
14. Prove:
- (a)  $\partial(S_1 \cup S_2) \subset \partial S_1 \cup \partial S_2$
  - (b)  $\partial(S_1 \cap S_2) \subset \partial S_1 \cup \partial S_2$
  - (c)  $\partial \bar{S} \subset \partial S$
  - (d)  $\partial S = \partial S^c$
  - (e)  $\partial(S - T) \subset \partial S \cup \partial T$
15. Show that
- $$\|\mathbf{X}\| = \max\{|x_1|, |x_2|, \dots, |x_n|\}$$
- is a norm on  $\mathbb{R}^n$ .
16. Suppose that  $(A_i, \rho_i)$ ,  $1 \leq i \leq k$ , are metric spaces. Let
- $$A = A_1 \times A_2 \times \cdots \times A_k = \{\mathbf{X} = (x_1, x_2, \dots, x_k) \mid x_i \in A_i, 1 \leq i \leq k\}.$$
- If  $\mathbf{X}$  and  $\mathbf{Y}$  are in  $A$ , let
- $$\rho(\mathbf{X}, \mathbf{Y}) = \sum_{i=1}^k \rho(x_i, y_i).$$
- (a) Show that  $\rho$  is a metric on  $A$ .

(b) Let  $\{\mathbf{X}_r\}_{r=1}^\infty = \{(x_{1r}, x_{2r}, \dots, x_{kr})\}_{r=1}^\infty$  be a sequence in  $A$ . Show that

$$\lim_{r \rightarrow \infty} \mathbf{X}_r = \widehat{\mathbf{X}} = (\widehat{x}_1, \widehat{x}_2, \dots, \widehat{x}_k)$$

if and only if

$$\lim_{r \rightarrow \infty} x_{ir} = \widehat{x}_i, \quad 1 \leq i \leq k.$$

(c) Show that  $\{\mathbf{X}_r\}_{r=1}^\infty$  is a Cauchy sequence in  $(A, \rho)$  if and only if  $\{x_{ir}\}_{r=1}^\infty$  is a Cauchy sequence in  $(A_i, \rho_i)$ ,  $1 \leq i \leq k$ .

(d) Show that  $(A, \rho)$  is complete if and only if  $(A_i, \rho_i)$  is complete,  $1 \leq i \leq k$ .

17. For each positive integer  $i$ , let  $(A_i, \rho_i)$  be a metric space. Let  $A$  be the set of all objects of the form  $\mathbf{X} = (x_1, x_2, \dots, x_n, \dots)$ , where  $x_i \in A_i$ ,  $i \geq 1$ . (For example, if  $A_i = \mathbb{R}$ ,  $i \geq 1$ , then  $A = \mathbb{R}^\infty$ .) Let  $\{\alpha_i\}_{i=1}^\infty$  be any sequence of positive numbers such that  $\sum_{i=1}^\infty \alpha_i < \infty$ .

(a) Show that

$$\rho(\mathbf{X}, \mathbf{Y}) = \sum_{i=1}^{\infty} \alpha_i \frac{\rho_i(x_i, y_i)}{1 + \rho_i(x_i, y_i)}$$

is a metric on  $A$ .

(b) Let  $\{\mathbf{X}_r\}_{r=1}^\infty = \{(x_{1r}, x_{2r}, \dots, x_{nr}, \dots)\}_{r=1}^\infty$  be a sequence in  $A$ . Show that

$$\lim_{r \rightarrow \infty} \mathbf{X}_r = \widehat{\mathbf{X}} = (\widehat{x}_1, \widehat{x}_2, \dots, \widehat{x}_n, \dots)$$

if and only if

$$\lim_{r \rightarrow \infty} x_{ir} = \widehat{x}_i, \quad i \geq 1.$$

(c) Show that  $\{\mathbf{X}_r\}_{r=1}^\infty$  is a Cauchy sequence in  $(A, \rho)$  if and only if  $\{x_{ir}\}_{r=1}^\infty$  is a Cauchy sequence in  $(A_i, \rho_i)$  for all  $i \geq 1$ .

(d) Show that  $(A, \rho)$  is complete if and only if  $(A_i, \rho_i)$  is complete for all  $i \geq 1$ .

18. Let  $C[0, \infty)$  be the set of all real-valued functions continuous on  $[0, \infty)$ . For each nonnegative integer  $n$ , let

$$\|f\|_n = \max \{|f(x)| \mid 0 \leq x \leq n\}$$

and

$$\rho_n(f, g) = \frac{\|f - g\|_n}{1 + \|f - g\|_n}.$$

Define

$$\rho(f, g) = \sum_{n=1}^{\infty} \frac{1}{2^{n-1}} \rho_n(f, g).$$

(a) Show that  $\rho$  is a metric on  $C[0, \infty)$ .

(b) Let  $\{f_k\}_{k=1}^{\infty}$  be a sequence of functions in  $C[0, \infty)$ . Show that

$$\lim_{k \rightarrow \infty} f_k = f$$

in the sense of Definition 8.1.14 if and only if

$$\lim_{k \rightarrow \infty} f_k(x) = f(x)$$

uniformly on every finite subinterval of  $[0, \infty)$ .

(c) Show that  $(C[0, \infty), \rho)$  is complete.

19. Show that Minkowski's inequality is false if  $0 < p < 1$ .

20. Suppose that  $0 < p < 1$ . Show that if  $u$  and  $v$  are nonnegative, then

$$(u + v)^p \leq u^p + v^p.$$

Use this to show that if  $\mathbf{X}, \mathbf{Y} \in \mathbb{R}^n$ ,

$$\rho(\mathbf{X}) = \sum_{i=1}^n |x_i|^p, \quad \text{and} \quad \rho(\mathbf{Y}) = \sum_{i=1}^n |y_i|^p,$$

then

$$\rho(\mathbf{X} + \mathbf{Y}) \leq \rho(\mathbf{X}) + \rho(\mathbf{Y}).$$

Is  $\rho$  a norm on  $\mathbb{R}^n$ ?

21. Suppose that  $\mathbf{X} = \{x_i\}_{i=1}^{\infty}$  is in  $\ell_p$ , where  $p > 1$ . Show that

(a)  $\mathbf{X} \in \ell_r$  for all  $r > p$ ;

(b) If  $r > p$ , then  $\|\mathbf{X}\|_r \leq \|\mathbf{X}\|_p$ ;

(c)  $\lim_{r \rightarrow \infty} \|\mathbf{X}\|_r = \|\mathbf{X}\|_{\infty}$ .

22. Let  $(A, \rho)$  be a metric space.

(a) Suppose that  $\{u_n\}$  and  $\{v_n\}$  are sequences in  $A$ ,  $\lim_{n \rightarrow \infty} u_n = u$ , and  $\lim_{n \rightarrow \infty} v_n = v$ . Show that  $\lim_{n \rightarrow \infty} \rho(u_n, v_n) = \rho(u, v)$ .

(b) Conclude from (a) that if  $\lim_{n \rightarrow \infty} u_n = u$  and  $v$  is arbitrary in  $A$ , then  $\lim_{n \rightarrow \infty} \rho(u_n, v) = \rho(u, v)$ .

23. Prove: If  $\{u_r\}_{r=1}^{\infty}$  is a Cauchy sequence in a normed vector space  $(A, \|\cdot\|)$ , then  $\{\|u_r\|\}_{r=1}^{\infty}$  is bounded.

24. Let

$$A = \left\{ \mathbf{X} \in \mathbb{R}^{\infty} \mid \text{the partial sums } \sum_{i=1}^n x_i, n \geq 1, \text{ are bounded} \right\}.$$

(a) Show that

$$\|\mathbf{X}\| = \sup_{n \geq 1} \left| \sum_{i=1}^n x_i \right|$$

is a norm on  $A$ .

(b) Let  $\rho(\mathbf{X}, \mathbf{Y}) = \|\mathbf{X} - \mathbf{Y}\|$ . Show that  $(A, \rho)$  is complete.



25. (a) Show that

$$\|f\| = \int_a^b |f(x)| dx$$

is a norm on  $C[a, b]$ ,

- (b) Show that the sequence  $\{f_n\}$  defined by

$$f_n(x) = \left(\frac{x-a}{b-a}\right)^n$$

is a Cauchy sequence in  $(C[a, b], \|\cdot\|)$ .

- (c) Show that  $(C[a, b], \|\cdot\|)$  is not complete.

26. (a) Verify that  $\ell_\infty$  is a normed vector space.

- (b) Show that  $\ell_\infty$  is complete.

27. Let  $A$  be the subset of  $\mathbb{R}^\infty$  consisting of convergent sequences  $\mathbf{X} = \{x_i\}_{i=1}^\infty$ . Define  $\|\mathbf{X}\| = \sup_{i \geq 1} |x_i|$ . Show that  $(A, \|\cdot\|)$  is a complete normed vector space.

28. Let  $A$  be the subset of  $\mathbb{R}^\infty$  consisting of sequences  $\mathbf{X} = \{x_i\}_{i=1}^\infty$  such that  $\lim_{i \rightarrow \infty} x_i = 0$ . Define  $\|\mathbf{X}\| = \max\{|x_i| \mid i \geq 1\}$ . Show that  $(A, \|\cdot\|)$  is a complete normed vector space.

29. (a) Show that  $\mathbb{R}_p^n$  is complete if  $p \geq 1$ .

- (b) Show that  $\ell_p$  is complete if  $p \geq 1$ .

30. Show that if  $\mathbf{X} = \{x_i\}_{i=1}^\infty \in \ell_p$  and  $\mathbf{Y} = \{y_i\}_{i=1}^\infty \in \ell_q$ , where  $1/p + 1/q = 1$ , then  $\mathbf{Z} = \{x_i y_i\} \in \ell_1$ .

## 8.2 COMPACT SETS IN A METRIC SPACE

Throughout this section it is to be understood that  $(A, \rho)$  is a metric space and that the sets under consideration are subsets of  $A$ .

We say that a collection  $\mathcal{H}$  of open subsets of  $A$  is an *open covering* of  $T$  if  $T \subset \cup \{H \mid H \in \mathcal{H}\}$ . We say that  $T$  has the *Heine–Borel property* if every open covering  $\mathcal{H}$  of  $T$  contains a finite collection  $\widehat{\mathcal{H}}$  such that

$$T \subset \cup \{H \mid H \in \widehat{\mathcal{H}}\}.$$

From Theorem 1.3.7, every nonempty closed and bounded subset of the real numbers has the Heine–Borel property. Moreover, from Exercise 1.3.21, any nonempty set of reals that has the Heine–Borel property is closed and bounded. Given these results, we defined a compact set of reals to be a closed and bounded set, and we now draw the following conclusion:

*A nonempty set of real numbers has the Heine–Borel property if and only if it is compact.*

The definition of boundedness of a set of real numbers is based on the ordering of the real numbers: if  $a$  and  $b$  are distinct real numbers then either  $a < b$  or  $b < a$ . Since there is no such ordering in a general metric space, we introduce the following definition.

**Definition 8.2.1** The *diameter* of a nonempty subset  $S$  of  $A$  is

$$d(S) = \sup \{ \rho(u, v) \mid u, v \in T \}.$$

If  $d(S) < \infty$  then  $S$  is *bounded*. ■

As we will see below, a closed and bounded subset of a general metric space may fail to have the Heine–Borel property. Since we want “compact” and “has the Heine–Borel property” to be synonymous in connection with a general metric space, we simply make the following definition.

**Definition 8.2.2** A set  $T$  is *compact* if it has the Heine–Borel property.

**Theorem 8.2.3** An infinite subset  $T$  of  $A$  is compact if and only if every infinite subset of  $T$  has a limit point in  $T$ .

**Proof** Suppose that  $T$  has an infinite subset  $E$  with no limit point in  $T$ . Then, if  $t \in T$ , there is an open set  $H_t$  such that  $t \in H_t$  and  $H_t$  contains at most one member of  $E$ . Then  $\mathcal{H} = \cup \{H_t \mid t \in T\}$  is an open covering of  $T$ , but no finite collection  $\{H_{t_1}, H_{t_2}, \dots, H_{t_k}\}$  of sets from  $\mathcal{H}$  can cover  $E$ , since  $E$  is infinite. Therefore, no such collection can cover  $T$ ; that is,  $T$  is not compact.

Now suppose that every infinite subset of  $T$  has a limit point in  $T$ , and let  $\mathcal{H}$  be an open covering of  $T$ . We first show that there is a sequence  $\{H_i\}_{i=1}^{\infty}$  of sets from  $\mathcal{H}$  that covers  $T$ .

If  $\epsilon > 0$ , then  $T$  can be covered by  $\epsilon$ -neighborhoods of finitely many points of  $T$ . We prove this by contradiction. Let  $t_1 \in T$ . If  $N_{\epsilon}(t_1)$  does not cover  $T$ , there is a  $t_2 \in T$  such that  $\rho(t_1, t_2) \geq \epsilon$ . Now suppose that  $n \geq 2$  and we have chosen  $t_1, t_2, \dots, t_n$  such that  $\rho(t_i, t_j) \geq \epsilon$ ,  $1 \leq i < j \leq n$ . If  $\cup_{i=1}^n N_{\epsilon}(t_i)$  does not cover  $T$ , there is a  $t_{n+1} \in T$  such that  $\rho(t_i, t_{n+1}) \geq \epsilon$ ,  $1 \leq i \leq n$ . Therefore,  $\rho(t_i, t_j) \geq \epsilon$ ,  $1 \leq i < j \leq n + 1$ . Hence, by induction, if no finite collection of  $\epsilon$ -neighborhoods of points in  $T$  covers  $T$ , there is an infinite sequence  $\{t_n\}_{n=1}^{\infty}$  in  $T$  such that  $\rho(t_i, t_j) \geq \epsilon$ ,  $i \neq j$ . Such a sequence could not have a limit point, contrary to our assumption.

By taking  $\epsilon$  successively equal to  $1, 1/2, \dots, 1/n, \dots$ , we can now conclude that, for each  $n$ , there are points  $t_{1n}, t_{2n}, \dots, t_{k_n, n}$  such that

$$T \subset \bigcup_{i=1}^{k_n} N_{1/n}(t_{in}).$$

Denote  $B_{in} = N_{1/n}(t_{in})$ ,  $1 \leq i \leq k_n$ ,  $n \geq 1$ , and define

$$\{G_1, G_2, G_3, \dots\} = \{B_{11}, \dots, B_{k_{1,1}}, B_{12}, \dots, B_{k_{2,2}}, B_{13}, \dots, B_{k_{3,3}}, \dots\}.$$

If  $t \in T$ , there is an  $H$  in  $\mathcal{H}$  such that  $t \in H$ . Since  $H$  is open, there is an  $\epsilon > 0$  such that  $N_\epsilon(t) \subset H$ . Since  $t \in G_j$  for infinitely many values of  $j$  and  $\lim_{j \rightarrow \infty} d(G_j) = 0$ ,

$$G_j \subset N_\epsilon(t) \subset H$$

for some  $j$ . Therefore, if  $\{G_{j_i}\}_{i=1}^\infty$  is the subsequence of  $\{G_j\}$  such that  $G_{j_i}$  is a subset of some  $H_i$  in  $\mathcal{H}$  (the  $\{H_i\}$  are not necessarily distinct), then

$$T \subset \bigcup_{i=1}^{\infty} H_i. \quad (8.2.1)$$

We will now show that

$$T \subset \bigcup_{i=1}^N H_i. \quad (8.2.2)$$

for some integer  $N$ . If this is not so, there is an infinite sequence  $\{t_n\}_{n=1}^\infty$  in  $T$  such that

$$t_n \notin \bigcup_{i=1}^n H_i, \quad n \geq 1. \quad (8.2.3)$$

From our assumption,  $\{t_n\}_{n=1}^\infty$  has a limit  $\bar{t}$  in  $T$ . From (8.2.1),  $\bar{t} \in H_k$  for some  $k$ , so  $N_\epsilon(\bar{t}) \subset H_k$  for some  $\epsilon > 0$ . Since  $\lim_{n \rightarrow \infty} t_n = \bar{t}$ , there is an integer  $N$  such that

$$t_n \in N_\epsilon(\bar{t}) \subset H_k \subset \bigcup_{i=1}^n H_i, \quad n > k,$$

which contradicts (8.2.3). This verifies (8.2.2), so  $T$  is compact. ■

Any finite subset of a metric space obviously has the Heine–Borel property and is therefore compact. Since Theorem 8.2.3 does not deal with finite sets, it is often more convenient to work with the following criterion for compactness, which is also applicable to finite sets.

**Theorem 8.2.4** *A subset  $T$  of a metric  $A$  is compact if and only if every infinite sequence  $\{t_n\}$  of members of  $T$  has a subsequence that converges to a member of  $T$ .*

**Proof** Suppose that  $T$  is compact and  $\{t_n\} \subset T$ . If  $\{t_n\}$  has only finitely many distinct terms, there is a  $\bar{t}$  in  $T$  such that  $t_n = \bar{t}$  for infinitely many values of  $n$ ; if this is so for  $n_1 < n_2 < \dots$ , then  $\lim_{j \rightarrow \infty} t_{n_j} = \bar{t}$ . If  $\{t_n\}$  has infinitely many distinct terms, then  $\{t_n\}$  has a limit point  $\bar{t}$  in  $T$ , so there are integers  $n_1 < n_2 < \dots$  such that  $\rho(t_{n_j}, \bar{t}) < 1/j$ ; therefore,  $\lim_{j \rightarrow \infty} t_{n_j} = \bar{t}$ .

Conversely, suppose that every sequence in  $T$  has a subsequence that converges to a limit in  $T$ . If  $S$  is an infinite subset of  $T$ , we can choose a sequence  $\{t_n\}$  of distinct points in  $S$ . By assumption,  $\{t_n\}$  has a subsequence that converges to a member  $\bar{t}$  of  $T$ . Since  $\bar{t}$  is a limit point of  $\{t_n\}$ , and therefore of  $T$ ,  $T$  is compact. ■

**Theorem 8.2.5** *If  $T$  is compact, then every Cauchy sequence  $\{t_n\}_{n=1}^\infty$  in  $T$  converges to a limit in  $T$ .*

**Proof** By Theorem 8.2.4,  $\{t_n\}$  has a subsequence  $\{t_{n_j}\}$  such that

$$\lim_{j \rightarrow \infty} t_{n_j} = \bar{t} \in T. \quad (8.2.4)$$

We will show that  $\lim_{n \rightarrow \infty} t_n = \bar{t}$ .

Suppose that  $\epsilon > 0$ . Since  $\{t_n\}$  is a Cauchy sequence, there is an integer  $N$  such that  $\rho(t_n, t_m) < \epsilon$ ,  $n > m \geq N$ . From (8.2.4), there is an  $m = n_j \geq N$  such that  $\rho(t_m, \bar{t}) < \epsilon$ . Therefore,

$$\rho(t_n, \bar{t}) \leq \rho(t_n, t_m) + \rho(t_m, \bar{t}) < 2\epsilon, \quad n \geq m. \quad \blacksquare$$

**Theorem 8.2.6** *If  $T$  is compact, then  $T$  is closed and bounded.*

**Proof** Suppose that  $\bar{t}$  is a limit point of  $T$ . For each  $n$ , choose  $t_n \neq \bar{t} \in B_{1/n}(\bar{t}) \cap T$ . Then  $\lim_{n \rightarrow \infty} t_n = \bar{t}$ . Since every subsequence of  $\{t_n\}$  also converges to  $\bar{t}$ ,  $\bar{t} \in T$ , by Theorem 8.2.3. Therefore,  $T$  is closed.

The family of unit open balls  $\mathcal{H} = \{B_1(t) \mid t \in T\}$  is an open covering of  $T$ . Since  $T$  is compact, there are finitely many members  $t_1, t_2, \dots, t_n$  of  $T$  such that  $S \subset \cup_{j=1}^n B_1(t_j)$ . If  $u$  and  $v$  are arbitrary members of  $T$ , then  $u \in B_1(t_r)$  and  $v \in B_1(t_s)$  for some  $r$  and  $s$  in  $\{1, 2, \dots, n\}$ , so

$$\begin{aligned} \rho(u, v) &\leq \rho(u, t_r) + \rho(t_r, t_s) + \rho(t_s, v) \\ &\leq 2 + \rho(t_r, t_s) \leq 2 + \max \{ \rho(t_i, t_j) \mid 1 \leq i < j \leq n \}. \end{aligned}$$

Therefore,  $T$  is bounded. ■

The converse of Theorem 8.2.6 is false; for example, if  $A$  is any infinite set equipped with the discrete metric (Example 8.1.2.), then every subset of  $A$  is bounded and closed. However, if  $T$  is an infinite subset of  $A$ , then  $\mathcal{H} = \{\{t\} \mid t \in T\}$  is an open covering of  $T$ , but no finite subfamily of  $\mathcal{H}$  covers  $T$ .

**Definition 8.2.7** A set  $T$  is *totally bounded* if for every  $\epsilon > 0$  there is a finite set  $T_\epsilon$  with the following property: if  $t \in T$ , there is an  $s \in T_\epsilon$  such that  $\rho(s, t) < \epsilon$ . We say that  $T_\epsilon$  is a *finite  $\epsilon$ -net* for  $T$ . ■

We leave it to you (Exercise 8.2.4) to show that every totally bounded set is bounded and that the converse is false.

**Theorem 8.2.8** *If  $T$  is compact, then  $T$  is totally bounded.*

**Proof** We will prove that if  $T$  is not totally bounded, then  $T$  is not compact. If  $T$  is not totally bounded, there is an  $\epsilon > 0$  such that there is no finite  $\epsilon$ -net for  $T$ . Let  $t_1 \in T$ . Then there must be a  $t_2$  in  $T$  such that  $\rho(t_1, t_2) > \epsilon$ . (If not, the singleton set  $\{t_1\}$  would be a finite  $\epsilon$ -net for  $T$ .) Now suppose that  $n \geq 2$  and we have chosen  $t_1, t_2, \dots, t_n$  such that  $\rho(t_i, t_j) \geq \epsilon$ ,  $1 \leq i < j \leq n$ . Then there must be a  $t_{n+1} \in T$  such that  $\rho(t_i, t_{n+1}) \geq \epsilon$ ,  $1 \leq i \leq n$ . (If not,  $\{t_1, t_2, \dots, t_n\}$  would be a finite  $\epsilon$ -net for  $T$ .) Therefore,  $\rho(t_i, t_j) \geq \epsilon$ ,  $1 \leq i < j \leq n + 1$ . Hence, by induction, there is an infinite sequence  $\{t_n\}_{n=1}^{\infty}$  in  $T$  such that  $\rho(t_i, t_j) \geq \epsilon$ ,  $i \neq j$ . Since such a sequence has no limit point,  $T$  is not compact, by Theorem 8.2.4. ■

**Theorem 8.2.9** *If  $(A, \rho)$  is complete and  $T$  is closed and totally bounded, then  $T$  is compact.*

**Proof** Let  $S$  be an infinite subset of  $T$ , and let  $\{s_i\}_{i=1}^{\infty}$  be a sequence of distinct members of  $S$ . We will show that  $\{s_i\}_{i=1}^{\infty}$  has a convergent subsequence. Since  $T$  is closed, the limit of this subsequence is in  $T$ , which implies that  $T$  is compact, by Theorem 8.2.4.

For  $n \geq 1$ , let  $T_{1/n}$  be a finite  $1/n$ -net for  $T$ . Let  $\{s_{i0}\}_{i=1}^{\infty} = \{s_i\}_{i=1}^{\infty}$ . Since  $T_1$  is finite and  $\{s_{i0}\}_{i=1}^{\infty}$  is infinite, there must be a member  $t_1$  of  $T_1$  such that  $\rho(s_{i0}, t_1) \leq 1$  for infinitely many values of  $i$ . Let  $\{s_{i1}\}_{i=1}^{\infty}$  be the subsequence of  $\{s_{i0}\}_{i=1}^{\infty}$  such that  $\rho(s_{i1}, t_1) \leq 1$ .

We continue by induction. Suppose that  $n > 1$  and we have chosen an infinite subsequence  $\{s_{i,n-1}\}_{i=1}^{\infty}$  of  $\{s_{i,n-2}\}_{i=1}^{\infty}$ . Since  $T_{1/n}$  is finite and  $\{s_{i,n-1}\}_{i=1}^{\infty}$  is infinite, there must be member  $t_n$  of  $T_{1/n}$  such that  $\rho(s_{i,n-1}, t_n) \leq 1/n$  for infinitely many values of  $i$ . Let  $\{s_{in}\}_{i=1}^{\infty}$  be the subsequence of  $\{s_{i,n-1}\}_{i=1}^{\infty}$  such that  $\rho(s_{in}, t_n) \leq 1/n$ . From the triangle inequality,

$$\rho(s_{in}, s_{jn}) \leq 2/n, \quad i, j \geq 1, \quad n \geq 1. \quad (8.2.5)$$

Now let  $\hat{s}_i = s_{ii}$ ,  $i \geq 1$ . Then  $\{\hat{s}_i\}_{i=1}^{\infty}$  is an infinite sequence of members of  $T$ . Moreover, if  $i, j \geq n$ , then  $\hat{s}_i$  and  $\hat{s}_j$  are both included in  $\{s_{in}\}_{i=1}^{\infty}$ , so (8.2.5) implies that  $\rho(\hat{s}_i, \hat{s}_j) \leq 2/n$ ; that is,  $\{\hat{s}_i\}_{i=1}^{\infty}$  is a Cauchy sequence and therefore has a limit, since  $(A, \rho)$  is complete. ■

**Example 8.2.1** Let  $T$  be the subset of  $\ell_{\infty}$  such that  $|x_i| \leq \mu_i$ ,  $i \geq 1$ , where  $\lim_{i \rightarrow \infty} \mu_i = 0$ . Show that  $T$  is compact.

**Solution** We will show that  $T$  is totally bounded in  $\ell_{\infty}$ . Since  $\ell_{\infty}$  is complete (Exercise 8.1.26), Theorem 8.2.9 will then imply that  $T$  is compact.

Let  $\epsilon > 0$ . Choose  $N$  so that  $\mu_i \leq \epsilon$  if  $i > N$ . Let  $\mu = \max\{\mu_i \mid 1 \leq i \leq N\}$  and let  $p$  be an integer such that  $p\epsilon > \mu$ . Let  $Q_{\epsilon} = \{r_i \in \mathbb{R} \mid r_i = \text{integer in } [-p, p]\}$ . Then the subset of  $\ell_{\infty}$  such that  $x_i \in Q_{\epsilon}$ ,  $1 \leq i \leq N$ , and  $x_i = 0$ ,  $i > N$ , is a finite  $\epsilon$ -net for  $T$ .

### Compact Subsets of $C[a, b]$

In Example 8.1.7 we showed that  $C[a, b]$  is a complete metric space under the metric

$$\rho(f, g) = \|f - g\| = \max\{|f(x) - g(x)| \mid a \leq x \leq b\}.$$

We will now give necessary and sufficient conditions for a subset of  $C[a, b]$  to be compact.

**Definition 8.2.10** A subset  $T$  of  $C[a, b]$  is *uniformly bounded* if there is a constant  $M$  such that

$$|f(x)| \leq M \quad \text{if} \quad a \leq x \leq b \quad \text{and} \quad f \in T. \quad (8.2.6)$$

A subset  $T$  of  $C[a, b]$  is *equicontinuous* if for each  $\epsilon > 0$  there is a  $\delta > 0$  such that

$$|f(x_1) - f(x_2)| \leq \epsilon \quad \text{if} \quad x_1, x_2 \in [a, b], \quad |x_1 - x_2| < \delta, \quad \text{and} \quad f \in T. \quad (8.2.7)$$

Theorem 2.2.8 implies that for each  $f$  in  $C[a, b]$  there is a constant  $M_f$  which depends on  $f$ , such that

$$|f(x)| \leq M_f \quad \text{if} \quad a \leq x \leq b,$$

and Theorem 2.2.12 implies that there is a constant  $\delta_f$  which depends on  $f$  and  $\epsilon$  such that

$$|f(x_1) - f(x_2)| \leq \epsilon \quad \text{if} \quad x_1, x_2 \in [a, b] \quad \text{and} \quad |x_1 - x_2| < \delta_f.$$

The difference in Definition 8.2.11 is that the *same*  $M$  and  $\delta$  apply to *all*  $f$  in  $T$ .

**Theorem 8.2.11** *A nonempty subset  $T$  of  $C[a, b]$  is compact if and only if it is closed, uniformly bounded, and equicontinuous.*

**Proof** For necessity, suppose that  $T$  is compact. Then  $T$  is closed (Theorem 8.2.6) and totally bounded (Theorem 8.2.8). Therefore, if  $\epsilon > 0$ , there is a finite subset  $T_\epsilon = \{g_1, g_2, \dots, g_k\}$  of  $C[a, b]$  such that if  $f \in T$ , then  $\|f - g_i\| \leq \epsilon$  for some  $i$  in  $\{1, 2, \dots, k\}$ . If we temporarily let  $\epsilon = 1$ , this implies that

$$\|f\| = \|(f - g_i) + g_i\| \leq \|f - g_i\| + \|g_i\| \leq 1 + \|g_i\|,$$

which implies (8.2.6) with

$$M = 1 + \max \{\|g_i\| \mid 1 \leq i \leq k\}.$$

For (8.2.7), we again let  $\epsilon$  be arbitrary, and write

$$\begin{aligned} |f(x_1) - f(x_2)| &\leq |f(x_1) - g_i(x_1)| + |g_i(x_1) - g_i(x_2)| + |g_i(x_2) - f(x_2)| \\ &\leq |g_i(x_1) - g_i(x_2)| + 2\|f - g_i\| \\ &< |g_i(x_1) - g_i(x_2)| + 2\epsilon. \end{aligned} \quad (8.2.8)$$

Since each of the finitely many functions  $g_1, g_2, \dots, g_k$  is uniformly continuous on  $[a, b]$  (Theorem 2.2.12), there is a  $\delta > 0$  such that

$$|g_i(x_1) - g_i(x_2)| < \epsilon \quad \text{if} \quad |x_1 - x_2| < \delta, \quad 1 \leq i \leq k.$$

This and (8.2.8) imply (8.2.7) with  $\epsilon$  replaced by  $3\epsilon$ . Since this replacement is of no consequence, this proves necessity.

For sufficiency, we will show that  $T$  is totally bounded. Since  $T$  is closed by assumption and  $C[a, b]$  is complete, Theorem 8.2.9 will then imply that  $T$  is compact.

Let  $m$  and  $n$  be positive integers and let

$$\xi_r = a + \frac{r}{m}(b - a), \quad 0 \leq r \leq m, \quad \text{and} \quad \eta_s = \frac{sM}{n}, \quad -n \leq s \leq n;$$

that is,  $a = \xi_0 < \xi_1 < \dots < \xi_m = b$  is a partition of  $[a, b]$  into subintervals of length  $(b - a)/m$ , and  $-M = \eta_{-n} < \eta_{-n+1} < \dots < \eta_{n-1} < \eta_n = M$  is a partition of the

segment of the  $y$ -axis between  $y = -M$  and  $y = M$  into subsegments of length  $M/n$ . Let  $S_{mn}$  be the subset of  $C[a, b]$  consisting of functions  $g$  such that

$$\{g(\xi_0), g(\xi_1), \dots, g(\xi_m)\} \subset \{\eta_{-n}, \eta_{-n+1}, \dots, \eta_{n-1}, \eta_n\}$$

and  $g$  is linear on  $[\xi_{i-1}, \xi_i]$ ,  $1 \leq i \leq m$ . Since there are only  $(m + 1)(2n + 1)$  points of the form  $(\xi_r, \eta_s)$ ,  $S_{mn}$  is a finite subset of  $C[a, b]$ .

Now suppose that  $\epsilon > 0$ , and choose  $\delta > 0$  to satisfy (8.2.7). Choose  $m$  and  $n$  so that  $(b - a)/m < \delta$  and  $2M/n < \epsilon$ . If  $f$  is an arbitrary member of  $T$ , there is a  $g$  in  $S_{mn}$  such that

$$|g(\xi_i) - f(\xi_i)| < \epsilon, \quad 0 \leq i \leq m. \tag{8.2.9}$$

If  $0 \leq i \leq m - 1$ ,

$$|g(\xi_i) - g(\xi_{i+1})| = |g(\xi_i) - f(\xi_i)| + |f(\xi_i) - f(\xi_{i+1})| + |f(\xi_{i+1}) - g(\xi_{i+1})|. \tag{8.2.10}$$

Since  $\xi_{i+1} - \xi_i < \delta$ , (8.2.7), (8.2.9), and (8.2.10) imply that

$$|g(\xi_i) - g(\xi_{i+1})| < 3\epsilon.$$

Therefore,

$$|g(\xi_i) - g(x)| < 3\epsilon, \quad \xi_i \leq x \leq \xi_{i+1}, \tag{8.2.11}$$

since  $g$  is linear on  $[\xi_i, \xi_{i+1}]$ .

Now let  $x$  be an arbitrary point in  $[a, b]$ , and choose  $i$  so that  $x \in [\xi_i, \xi_{i+1}]$ . Then

$$|f(x) - g(x)| \leq |f(x) - f(\xi_i)| + |f(\xi_i) - g(\xi_i)| + |g(\xi_i) - g(x)|,$$

so (8.2.7), (8.2.9), and (8.2.11) imply that  $|f(x) - g(x)| < 5\epsilon$ ,  $a \leq x \leq b$ . Therefore,  $S_{mn}$  is a finite  $5\epsilon$ -net for  $T$ , so  $T$  is totally bounded. ■

**Theorem 8.2.12 (Ascoli–Arzela Theorem)** *Suppose that  $\mathcal{F}$  is an infinite uniformly bounded and equicontinuous family of functions on  $[a, b]$ . Then there is a sequence  $\{f_n\}$  in  $\mathcal{F}$  that converges uniformly to a continuous function on  $[a, b]$ .*

**Proof** Let  $T$  be the closure of  $\mathcal{F}$ ; that is,  $f \in T$  if and only if either  $f \in \mathcal{F}$  or  $f$  is the uniform limit of a sequence of members of  $\mathcal{F}$ . Then  $T$  is also uniformly bounded and equicontinuous (verify), and  $T$  is closed. Hence,  $T$  is compact, by Theorem 8.2.12. Therefore,  $\mathcal{F}$  has a limit point in  $T$ . (In this context, the limit point is a function  $f$  in  $T$ .) Since  $f$  is a limit point of  $\mathcal{F}$ , there is for each integer  $n$  a function  $f_n$  in  $\mathcal{F}$  such that  $\|f_n - f\| < 1/n$ ; that is  $\{f_n\}$  converges uniformly to  $f$  on  $[a, b]$ . ■

### 8.2 Exercises

1. Suppose that  $T_1, T_2, \dots, T_k$  are compact sets in a metric space  $(A, \rho)$ . Show that  $\cup_{j=1}^k T_j$  is compact.



2. (a) Show that a closed subset of a compact set is compact.  
 (b) Suppose that  $\mathcal{T}$  is any collection of closed subsets of a metric space  $(A, \rho)$ , and some  $\widehat{T}$  in  $\mathcal{T}$  is compact. Show that  $\bigcap \{T \mid T \in \mathcal{T}\}$  is compact.  
 (c) Show that if  $\mathcal{T}$  is a collection of compact subsets of a metric space  $(A, \rho)$ , then  $\bigcap \{T \mid T \in \mathcal{T}\}$  is compact.
3. If  $S$  and  $T$  are nonempty subsets of a metric space  $(A, \rho)$ , we define the *distance from  $S$  to  $T$*  by

$$\text{dist}(S, T) = \inf \{ \rho(s, t) \mid s \in S, t \in T \}.$$

Show that if  $S$  and  $T$  are compact, then  $\text{dist}(S, T) = \rho(s, t)$  for some  $s$  in  $S$  and some  $t$  in  $T$ .

4. (a) Show that every totally bounded set is bounded.  
 (b) Let

$$\delta_{ir} = \begin{cases} 1 & \text{if } i = r, \\ 0 & \text{if } i \neq r, \end{cases}$$

and let  $T$  be the subset of  $\ell_\infty$  consisting of the sequences  $\mathbf{X}_r = \{\delta_{ir}\}_{i=1}^\infty$ ,  $r \geq 1$ . Show that  $T$  is bounded, but not totally bounded.

5. Let  $T$  be a compact subset of a metric space  $(A, \rho)$ . Show that there are members  $\bar{s}$  and  $\bar{t}$  of  $T$  such that  $d(\bar{s}, \bar{t}) = d(T)$ .
6. Let  $T$  be the subset of  $\ell_1$  such that  $|x_i| \leq \mu_i$ ,  $i \geq 1$ , where  $\sum_{i=1}^\infty \mu_i < \infty$ . Show that  $T$  is compact.
7. Let  $T$  be the subset of  $\ell_2$  such that  $|x_i| \leq \mu_i$ ,  $i \geq 1$ , where  $\sum_{i=1}^\infty \mu_i^2 < \infty$ . Show that  $T$  is compact.
8. Let  $S$  be a nonempty subset of a metric space  $(A, \rho)$  and let  $u_0$  be an arbitrary member of  $A$ . Show that  $S$  is bounded if and only if  $D = \{\rho(u, u_0) \mid u \in S\}$  is bounded.
9. Let  $(A, \rho)$  be a metric space.  
 (a) Prove: If  $S$  is a bounded subset of  $A$ , then  $\overline{S}$  (closure of  $S$ ) is bounded. Find  $d(\overline{S})$ .  
 (b) Prove: If every bounded closed subset of  $A$  is compact, then  $(A, \rho)$  is complete.
10. Let  $(A, \rho)$  be the metric space defined in Exercise 8.1.16. Let

$$T = T_1 \times T_2 \times \cdots \times T_k,$$

where  $T_i \subset A_i$  and  $T_i \neq \emptyset$ ,  $1 \leq i \leq k$ . Show that  $T$  is compact if and only if  $T_i$  is compact for  $1 \leq i \leq k$ .

11. Let  $(A, \rho)$  be the metric space defined in Exercise 8.1.17. Let

$$T = T_1 \times T_2 \times \cdots \times T_n \times \cdots,$$

where  $T_i \subset A_i$  and  $T_i \neq \emptyset$ ,  $i \geq 1$ . Show that if  $T$  is compact, then  $T_i$  is compact for all  $i \geq 1$ .

- 12.** Let  $\{T_n\}_{n=1}^{\infty}$  be a sequence of nonempty closed sets of a metric space such that (a)  $T_1$  is compact; (b)  $T_{n+1} \subset T_n$ ,  $n \geq 1$ ; and (c)  $\lim_{n \rightarrow \infty} d(T_n) = 0$ . Show that  $\bigcap_{n=1}^{\infty} T_n$  contains exactly one member.

### 8.3 CONTINUOUS FUNCTIONS ON METRIC SPACES

In Chapter 6 we studied real-valued functions defined on subsets of  $\mathbb{R}^n$ , and in Chapter 6.4 we studied functions defined on subsets of  $\mathbb{R}^n$  with values in  $\mathbb{R}^m$ . These are examples of functions defined on one metric space with values in another metric space. (Of course, the two spaces are the same if  $n = m$ .)

In this section we briefly consider functions defined on subsets of a metric space  $(A, \rho)$  with values in a metric space  $(B, \sigma)$ . We indicate that  $f$  is such a function by writing

$$f : (A, \rho) \rightarrow (B, \sigma).$$

The *domain* and *range* of  $f$  are the sets

$$D_f = \{u \in A \mid f(u) \text{ is defined}\}$$

and

$$R_f = \{v \in B \mid v = f(u) \text{ for some } u \text{ in } D_f\}.$$

**Definition 8.3.1** We say that

$$\lim_{u \rightarrow \hat{u}} f(u) = \hat{v}$$

if  $\hat{u} \in \overline{D_f}$  and for each  $\epsilon > 0$  there is a  $\delta > 0$  such that

$$\sigma(f(u), \hat{v}) < \epsilon \quad \text{if } u \in D_f \quad \text{and} \quad 0 < \rho(u, \hat{u}) < \delta. \quad (8.3.1)$$

**Definition 8.3.2** We say that  $f$  is *continuous* at  $\hat{u}$  if  $\hat{u} \in D_f$  and for each  $\epsilon > 0$  there is a  $\delta > 0$  such that

$$\sigma(f(u), f(\hat{u})) < \epsilon \quad \text{if } u \in D_f \cap N_{\delta}(\hat{u}). \quad (8.3.2)$$

If  $f$  is continuous at every point of a set  $S$ , then  $f$  is *continuous on*  $S$ . ■

Note that (8.3.2) can be written as

$$f(D_f \cap N_{\delta}(\hat{u})) \subset N_{\epsilon}(f(\hat{u})).$$

Also,  $f$  is automatically continuous at every isolated point of  $D_f$ . (Why?)

**Example 8.3.1** If  $(A, \|\cdot\|)$  is a normed vector space, then Theorem 8.3.5 implies that  $f(u) = \|u\|$  is a continuous function from  $(A, \rho)$  to  $\mathbb{R}$ , since

$$\left| \|u\| - \|\widehat{u}\| \right| \leq \|u - \widehat{u}\|.$$

Here we are applying Definition 8.3.2 with  $\rho(u, \widehat{u}) = \|u - \widehat{u}\|$  and  $\sigma(v, \widehat{v}) = |v - \widehat{v}|$ .

**Theorem 8.3.3** Suppose that  $\widehat{u} \in \overline{D_f}$ . Then

$$\lim_{u \rightarrow \widehat{u}} f(u) = \widehat{v} \quad (8.3.3)$$

if and only if

$$\lim_{n \rightarrow \infty} f(u_n) = \widehat{v} \quad (8.3.4)$$

for every sequence  $\{u_n\}$  in  $D_f$  such that

$$\lim_{n \rightarrow \infty} u_n = \widehat{u}. \quad (8.3.5)$$

**Proof** Suppose that (8.3.3) is true, and let  $\{u_n\}$  be a sequence in  $D_f$  that satisfies (8.3.5). Let  $\epsilon > 0$  and choose  $\delta > 0$  to satisfy (8.3.1). From (8.3.5), there is an integer  $N$  such that  $\rho(u_n, \widehat{u}) < \delta$  if  $n \geq N$ . Therefore,  $\sigma(f(u_n), \widehat{v}) < \epsilon$  if  $n \geq N$ , which implies (8.3.4).

For the converse, suppose that (8.3.3) is false. Then there is an  $\epsilon_0 > 0$  and a sequence  $\{u_n\}$  in  $D_f$  such that  $\rho(u_n, \widehat{u}) < 1/n$  and  $\sigma(f(u_n), \widehat{v}) \geq \epsilon_0$ , so (8.3.4) is false. ■

We leave the proof of the next two theorems to you.

**Theorem 8.3.4** A function  $f$  is continuous at  $\widehat{u}$  if and only if

$$\lim_{u \rightarrow \widehat{u}} f(u) = f(\widehat{u}).$$

**Theorem 8.3.5** A function  $f$  is continuous at  $\widehat{u}$  if and only if

$$\lim_{n \rightarrow \infty} f(u_n) = f(\widehat{u})$$

whenever  $\{u_n\}$  is a sequence in  $D_f$  that converges to  $\widehat{u}$ .

**Theorem 8.3.6** If  $f$  is continuous on a compact set  $T$ , then  $f(T)$  is compact.

**Proof** Let  $\{v_n\}$  be an infinite sequence in  $f(T)$ . For each  $n$ ,  $v_n = f(u_n)$  for some  $u_n \in T$ . Since  $T$  is compact,  $\{u_n\}$  has a subsequence  $\{u_{n_j}\}$  such that  $\lim_{j \rightarrow \infty} u_{n_j} = \widehat{u} \in T$  (Theorem 8.2.4). From Theorem 8.3.5,  $\lim_{j \rightarrow \infty} f(u_{n_j}) = f(\widehat{u})$ ; that is,  $\lim_{j \rightarrow \infty} v_{n_j} = f(\widehat{u})$ . Therefore,  $f(T)$  is compact, again by Theorem 8.2.4. ■

**Definition 8.3.7** A function  $f$  is *uniformly continuous* on a subset  $S$  of  $D_f$  if for each  $\epsilon > 0$  there is a  $\delta > 0$  such that

$$\sigma(f(u), f(v)) < \epsilon \quad \text{whenever} \quad \rho(u, v) < \delta \quad \text{and} \quad u, v \in S.$$

**Theorem 8.3.8** *If  $f$  is continuous on a compact set  $T$ , then  $f$  is uniformly continuous on  $T$ .*

**Proof** If  $f$  is not uniformly continuous on  $T$ , then for some  $\epsilon_0 > 0$  there are sequences  $\{u_n\}$  and  $\{v_n\}$  in  $T$  such that  $\rho(u_n, v_n) < 1/n$  and

$$\sigma(f(u_n), f(v_n)) \geq \epsilon_0. \quad (8.3.6)$$

Since  $T$  is compact,  $\{u_n\}$  has a subsequence  $\{u_{n_k}\}$  that converges to a limit  $\widehat{u}$  in  $T$  (Theorem 8.2.4). Since  $\rho(u_{n_k}, v_{n_k}) < 1/n_k$ ,  $\lim_{k \rightarrow \infty} v_{n_k} = \widehat{u}$  also. Then

$$\lim_{k \rightarrow \infty} f(u_{n_k}) = \lim_{k \rightarrow \infty} f(v_{n_k}) = f(\widehat{u})$$

(Theorem 8.3.5), which contradicts (8.3.6). ■

**Definition 8.3.9** If  $f : (A, \rho) \rightarrow (A, \rho)$  is defined on all of  $A$  and there is a constant  $\alpha$  in  $(0, 1)$  such that

$$\rho(f(u), f(v)) \leq \alpha \rho(u, v) \quad \text{for all } (u, v) \in A \times A, \quad (8.3.7)$$

then  $f$  is a *contraction* of  $(A, \rho)$ . ■

We note that a contraction of  $(A, \rho)$  is uniformly continuous on  $A$ .

**Theorem 8.3.10 (Contraction Mapping Theorem)** *If  $f$  is a contraction of a complete metric space  $(A, \rho)$ , then the equation*

$$f(u) = u \quad (8.3.8)$$

*has a unique solution.*

**Proof** To see that (8.3.8) cannot have more than one solution, suppose that  $u = f(u)$  and  $v = f(v)$ . Then

$$\rho(u, v) = \rho(f(u), f(v)). \quad (8.3.9)$$

However, (8.3.7) implies that

$$\rho(f(u), f(v)) \leq \alpha \rho(u, v). \quad (8.3.10)$$

Since (8.3.9) and (8.3.10) imply that

$$\rho(u, v) \leq \alpha \rho(u, v)$$

and  $\alpha < 1$ , it follows that  $\rho(u, v) = 0$ . Hence  $u = v$ .

We will now show that (8.3.8) has a solution. With  $u_0$  arbitrary, define

$$u_n = f(u_{n-1}), \quad n \geq 1. \quad (8.3.11)$$

We will show that  $\{u_n\}$  converges. From (8.3.7) and (8.3.11),

$$\rho(u_{n+1}, u_n) = \rho(f(u_n), f(u_{n-1})) \leq \alpha \rho(u_n, u_{n-1}). \quad (8.3.12)$$

The inequality

$$\rho(u_{n+1}, u_n) \leq \alpha^n \rho(u_1, u_0), \quad n \geq 0, \quad (8.3.13)$$

follows by induction from (8.3.12). If  $n > m$ , repeated application of the triangle inequality yields

$$\rho(u_n, u_m) \leq \rho(u_n, u_{n-1}) + \rho(u_{n-1}, u_{n-2}) + \cdots + \rho(u_{m+1}, u_m),$$

and (8.3.13) yields

$$\rho(u_n, u_m) \leq \rho(u_1, u_0) \alpha^m (1 + \alpha + \cdots + \alpha^{n-m-1}) < \frac{\alpha^m}{1 - \alpha}.$$

Now it follows that

$$\rho(u_n, u_m) < \frac{\rho(u_1, u_0)}{1 - \alpha} \alpha^N \quad \text{if } n, m > N,$$

and, since  $\lim_{N \rightarrow \infty} \alpha^N = 0$ ,  $\{u_n\}$  is a Cauchy sequence. Since  $A$  is complete,  $\{u_n\}$  has a limit  $\hat{u}$ . Since  $f$  is continuous at  $\hat{u}$ ,

$$f(\hat{u}) = \lim_{n \rightarrow \infty} f(u_{n-1}) = \lim_{n \rightarrow \infty} u_n = \hat{u},$$

where Theorem 8.3.5 implies the first equality and (8.3.11) implies the second. ■

**Example 8.3.2** Suppose that  $h = h(x)$  is continuous on  $[a, b]$ ,  $K = K(x, y)$  is continuous on  $[a, b] \times [a, b]$ , and  $|K(x, y)| \leq M$  if  $a \leq x, y \leq b$ . Show that if  $|\lambda| < 1/M(b - a)$  there is a unique  $u$  in  $C[a, b]$  such that

$$u(x) = h(x) + \lambda \int_a^b K(x, y)u(y) dy, \quad a \leq x \leq b. \quad (8.3.14)$$

(This is *Fredholm's integral equation*.)

**Solution** Let  $A$  be  $C[a, b]$ , which is complete. If  $u \in C[a, b]$ , let  $f(u) = v$ , where

$$v(x) = h(x) + \lambda \int_a^b K(x, y)u(y) dy, \quad a \leq x \leq b.$$

Since  $v \in C[a, b]$ ,  $f : C[a, b] \rightarrow C[a, b]$ . If  $u_1, u_2 \in C[a, b]$ , then

$$|v_1(x) - v_2(x)| \leq |\lambda| \int_a^b |K(x, y)| |u_1(y) - u_2(y)| dy,$$

so

$$\|v_1 - v_2\| \leq |\lambda| M(b - a) \|u_1 - u_2\|.$$

Since  $|\lambda| M(b - a) < 1$ ,  $f$  is a contraction. Hence, there is a unique  $u$  in  $C[a, b]$  such that  $f(u) = u$ . This  $u$  satisfies (8.3.14).

## 8.3 Exercises

1. Suppose that  $f : (A, \rho) \rightarrow (B, \sigma)$  and  $D_f = A$ . Show that the following statements are equivalent.
  - (a)  $f$  is continuous on  $A$ .
  - (b) If  $V$  is any open set in  $(B, \sigma)$ , then  $f^{-1}(V)$  is open in  $(A, \rho)$ .
  - (c) If  $V$  is any closed set in  $(B, \sigma)$ , then  $f^{-1}(V)$  is closed in  $(A, \rho)$ .
2. A metric space  $(A, \rho)$  is *connected* if  $A$  cannot be written as  $A = A_1 \cup A_2$ , where  $A_1$  and  $A_2$  are nonempty disjoint open sets. Suppose that  $(A, \rho)$  is connected and  $f : (A, \rho) \rightarrow (B, \sigma)$ , where  $D_f = A$ ,  $R_f = B$ , and  $f$  is continuous on  $A$ . Show that  $(B, \sigma)$  is connected.
3. Let  $f$  be a continuous real-valued function on a compact subset  $S$  of a metric space  $(A, \rho)$ . Let  $\sigma$  be the usual metric on  $\mathbb{R}$ ; that is,  $\sigma(x, y) = |x - y|$ .
  - (a) Show that  $f$  is bounded on  $S$ .
  - (b) Let  $\alpha = \inf_{u \in S} f(u)$  and  $\beta = \sup_{u \in S} f(u)$ . Show that there are points  $u_1$  and  $u_2$  in  $[a, b]$  such that  $f(u_1) = \alpha$  and  $f(u_2) = \beta$ .
4. Let  $f : (A, \rho) \rightarrow (B, \sigma)$  be continuous on a subset  $U$  of  $A$ . Let  $\bar{u}$  be in  $U$  and define the real-valued function  $g : (A, \rho) \rightarrow \mathbb{R}$  by

$$g(u) = \sigma(f(u), f(\bar{u})), \quad u \in U.$$

- (a) Show that  $g$  is continuous on  $U$ .
  - (b) Show that if  $U$  is compact, then  $g$  is uniformly continuous on  $U$ .
  - (c) Show that if  $U$  is compact, then there is a  $\hat{u} \in U$  such that  $g(u) \leq g(\hat{u})$ ,  $u \in U$ .
5. Suppose that  $(A, \rho)$ ,  $(B, \sigma)$ , and  $(C, \gamma)$  are metric spaces, and let

$$f : (A, \rho) \rightarrow (B, \sigma) \quad \text{and} \quad g : (B, \sigma) \rightarrow (C, \gamma),$$

where  $D_f = A$ ,  $R_f = D_g = B$ , and  $f$  and  $g$  are continuous. Define  $h : (A, \rho) \rightarrow (C, \gamma)$  by  $h(u) = g(f(u))$ . Show that  $h$  is continuous on  $A$ .

6. Let  $(A, \rho)$  be the set of all bounded real-valued functions on a nonempty set  $S$ , with  $\rho(u, v) = \sup_{s \in S} |u(s) - v(s)|$ . Let  $s_1, s_2, \dots, s_k$  be members of  $S$ , and  $f(u) = g(u(s_1), u(s_2), \dots, u(s_k))$ , where  $g$  is real-valued and continuous on  $\mathbb{R}^k$ . Show that  $f$  is a continuous function from  $(A, \rho)$  to  $\mathbb{R}$ .
7. Let  $(A, \rho)$  be the set of all bounded real-valued functions on a nonempty set  $S$ , with  $\rho(u, v) = \sup_{s \in S} |u(s) - v(s)|$ . Show that  $f(u) = \inf_{s \in S} u(s)$  and  $g(u) = \sup_{s \in S} u(s)$  are uniformly continuous functions from  $(A, \rho)$  to  $\mathbb{R}$ .
8. Let  $I[a, b]$  be the set of all real-valued functions that are Riemann integrable on  $[a, b]$ , with  $\rho(u, v) = \sup_{a \leq x \leq b} |u(x) - v(x)|$ . Show that  $f(u) = \int_a^b u(x) dx$  is a uniformly continuous function from  $I[a, b]$  to  $\mathbb{R}$ .

## Answers to Selected Exercises

### Section 1.1 pp. 9–10

1.1.1 (p. 9) (a)  $2 \max(a, b)$  (b)  $2 \min(a, b)$  (c)  $4 \max(a, b, c)$  (d)  $4 \min(a, b, c)$

1.1.5 (p. 9) (a)  $\infty$  (no);  $-1$  (yes) (b)  $3$  (no);  $-3$  (no) (c)  $\sqrt{7}$  (yes);  $-\sqrt{7}$  (yes)  
 (d)  $2$  (no);  $-3$  (no) (e)  $1$  (no);  $-1$  (no) (f)  $\sqrt{7}$  (no);  $-\sqrt{7}$  (no)

### Section 1.2 pp. 15–19

1.2.9 (p. 16) (a)  $2^n/(2n)!$  (b)  $2 \cdot 3^n/(2n+1)!$  (c)  $2^{-n}(2n)!/(n!)^2$  (d)  $n^n/n!$

1.2.10 (p. 16) (b) no 1.2.11 (p. 16) (b) no

1.2.20 (p. 18)  $A_n = \frac{x^n}{n!} \left( \ln x - \sum_{j=1}^n \frac{1}{j} \right)$

1.2.21 (p. 18)  $f_n(x_1, x_2, \dots, x_n) = 2^{n-1} \max(x_1, x_2, \dots, x_n)$ ,  $g_n(x_1, x_2, \dots, x_n) = 2^{n-1} \min(x_1, x_2, \dots, x_n)$

### Section 1.3 pp. 27–29

1.3.1 (p. 27) (a)  $[\frac{1}{2}, 1)$ ;  $(-\infty, \frac{1}{2}) \cup [1, \infty)$ ;  $(-\infty, 0] \cup (\frac{3}{2}, \infty)$ ;  $(0, \frac{3}{2}]$ ;  $(-\infty, 0] \cup (\frac{3}{2}, \infty)$ ;  
 $(-\infty, \frac{1}{2}] \cup [1, \infty)$  (b)  $(-3, -2) \cup (2, 3)$ ;  $(-\infty, -3] \cup [-2, 2] \cup [3, \infty)$ ;  $\emptyset$ ;  $(-\infty, \infty)$ ;  $\emptyset$ ;  
 $(-\infty, -3] \cup [-2, 2] \cup [3, \infty)$  (c)  $\emptyset$ ;  $(-\infty, \infty)$ ;  $\emptyset$ ;  $(-\infty, \infty)$ ;  $\emptyset$ ;  $(-\infty, \infty)$

(d)  $\emptyset$ ;  $(-\infty, \infty)$ ;  $[-1, 1]$ ;  $(-\infty, -1) \cup (1, \infty)$ ;  $[-1, 1]$ ;  $(-\infty, \infty)$

1.3.2 (p. 27) (a)  $(0, 3]$  (b)  $[0, 2]$  (c)  $(-\infty, 1) \cup (2, \infty)$  (d)  $(-\infty, 0] \cup (3, \infty)$

1.3.4 (p. 27) (a)  $\frac{1}{4}$  (b)  $\frac{1}{6}$  (c)  $6$  (d)  $1$

- 1.3.5 (p. 27)** (a) neither;  $(-1, 2) \cup (3, \infty)$ ;  $(-\infty, -1) \cup (2, 3)$ ;  $(-\infty, -1] \cup (2, 3)$ ;  $(-\infty, -1] \cup [2, 3]$  (b) open;  $S$ ;  $(1, 2)$ ;  $[1, 2]$  (c) closed;  $(-3, -2) \cup (7, 8)$ ;  $(-\infty, -3) \cup (-2, 7) \cup (8, \infty)$ ;  $(-\infty, -3] \cup [-2, 7] \cup [8, \infty)$  (d) closed;  $\emptyset$ ;  $\bigcup \{(n, n+1) \mid n = \text{integer}\}$ ;  $(-\infty, \infty)$
- 1.3.20 (p. 28)** (a)  $\{x \mid x = 1/n, n = 1, 2, \dots\}$ ; (b)  $\emptyset$  (c), (d)  $S_1 = \text{rationals}$ ,  $S_2 = \text{irrationals}$  (e) any set whose supremum is an isolated point of the set (f), (g) the rationals (h)  $S_1 = \text{rationals}$ ,  $S_2 = \text{irrationals}$

**Section 2.1 pp. 48–53**

- 2.1.2 (p. 48)**  $D_f = [-2, 1) \cup [3, \infty)$ ,  $D_g = (-\infty, -3] \cup [3, 7) \cup (7, \infty)$ ,  $D_{f \pm g} = D_{fg} = [3, 7) \cup (7, \infty)$ ,  $D_{f/g} = (3, 4) \cup (4, 7) \cup (7, \infty)$
- 2.1.3 (p. 48)** (a), (b)  $\{x \mid x \neq (2k+1)\pi/2 \text{ where } k = \text{integer}\}$  (c)  $\{x \mid x \neq 0, 1\}$  (d)  $\{x \mid x \neq 0\}$  (e)  $[1, \infty)$
- 2.1.4 (p. 49)** (a) 4 (b) 12 (c)  $-1$  (d) 2 (e)  $-2$
- 2.1.6 (p. 49)** (a)  $\frac{11}{17}$  (b)  $-\frac{2}{3}$  (c)  $\frac{1}{3}$  (d) 2
- 2.1.7 (p. 49)** (a) 0, 2 (b) 0, none (c)  $-\frac{1}{3}, \frac{1}{3}$  (d) none, 0
- 2.1.15 (p. 50)** (a) 0 (b) 0 (c) none (d) 0 (e) none (f) 0
- 2.1.18 (p. 50)** (a) 0 (b) 0 (c) none (d) none (e) none (f) 0
- 2.1.20 (p. 50)** (a)  $\infty$  (b)  $-\infty$  (c)  $\infty$  (d)  $\infty$  (e)  $\infty$  (f)  $-\infty$
- 2.1.22 (p. 51)** (a) none (b)  $\infty$  (c)  $\infty$  (d) none
- 2.1.24 (p. 51)** (a)  $\infty$  (b)  $\infty$  (c)  $\infty$  (d)  $-\infty$  (e) none (f)  $\infty$
- 2.1.31 (p. 52)** (a)  $\frac{3}{2}$  (b)  $\frac{3}{2}$  (c)  $\infty$  (d)  $-\infty$  (e)  $\infty$  (f)  $\frac{1}{2}$
- 2.1.32 (p. 52)**  $\lim_{x \rightarrow \infty} r(x) = \infty$  if  $n > m$  and  $a_n/b_m > 0$ ;  $= -\infty$  if  $n > m$  and  $a_n/b_m < 0$ ;  $= a_n/b_m$  if  $n = m$ ;  $= 0$  if  $n < m$ .  $\lim_{x \rightarrow -\infty} r(x) = (-1)^{n-m} \lim_{x \rightarrow \infty} r(x)$
- 2.1.33 (p. 52)**  $\lim_{x \rightarrow x_0} f(x) = \lim_{x \rightarrow x_0} g(x)$
- 2.1.37 (p. 52)** (c)  $\overline{\lim}_{x \rightarrow x_0-} (f-g)(x) \leq \overline{\lim}_{x \rightarrow x_0-} f(x) - \underline{\lim}_{x \rightarrow x_0-} g(x)$ ;  $\underline{\lim}_{x \rightarrow x_0-} (f-g)(x) \geq \underline{\lim}_{x \rightarrow x_0-} f(x) - \overline{\lim}_{x \rightarrow x_0-} g(x)$

**Section 2.2 pp. 69–73**

- 2.2.3 (p. 69)** (a) from the right (b) continuous (c) none (d) continuous (e) none (f) continuous (g) from the left
- 2.2.4 (p. 69)**  $[0, 1)$ ,  $(0, 1)$ ,  $[1, 2)$ ,  $(1, 2)$ ,  $(1, 2]$ ,  $[1, 2]$  **2.2.5 (p. 69)**  $[0, 1)$ ,  $(0, 1)$ ,  $(1, \infty)$  **2.2.13 (p. 70)** (b)  $\tanh x$  is continuous for all  $x$ ,  $\coth x$  for all  $x \neq 0$



2.2.16 (p. 70) No 2.2.21 (p. 71) (a)  $[-1, 1], [0, \infty)$  (b)  $\bigcup_{n=-\infty}^{\infty} (2n\pi, (2n+1)\pi)$ ,  $(0, \infty)$  (c)  $\bigcup_{n=-\infty}^{\infty} (n\pi, (n+1)\pi)$ ,  $(-\infty, -1) \cup (-1, 1) \cup (1, \infty)$  (d)  $\bigcup_{n=-\infty}^{\infty} [n\pi, (n + \frac{1}{2})\pi]$ ,  $[0, \infty)$

2.2.23 (p. 71) (a)  $(-1, 1)$  (b)  $(-\infty, \infty)$  (c)  $x_0 \neq (2k + \frac{3}{2})\pi$ ,  $k = \text{integer}$  (d)  $x \neq \frac{1}{2}$  (e)  $x \neq 1$  (f)  $x \neq (k + \frac{1}{2})\pi$ ,  $k = \text{integer}$  (g)  $x \neq (k + \frac{1}{2})\pi$ ,  $k = \text{integer}$  (h)  $x \neq 0$  (i)  $x \neq 0$

### Section 2.3 pp. 84–88

2.3.4 (p. 85) (b)  $p(c) = q(c)$  and  $p'_-(c) = q'_+(c)$

2.3.5 (p. 85)  $f^{(k)}(x) = n(n-1)\cdots(n-k-1)x^{n-k-1}|x|$  if  $1 \leq k \leq n-1$ ;  $f^{(n)}(x) = n!$  if  $x > 0$ ;  $f^{(n)}(x) = -n!$  if  $x < 0$ ;  $f^{(k)}(x) = 0$  if  $k > n$  and  $x \neq 0$ ;  $f^{(k)}(0)$  does not exist if  $k \geq n$ .

2.3.7 (p. 85) (a)  $c' = ac - bs$ ,  $s' = bc + as$  (b)  $c(x) = e^{ax} \cos bx$ ,  $s(x) = e^{ax} \sin bx$

2.3.15 (p. 86) (b)  $f(x) = -1$  if  $x \leq 0$ ,  $f(x) = 1$  if  $x > 0$ ; then  $f'(0+) = 0$ , but  $f'_+(0)$  does not exist. (c) continuous from the right

2.3.22 (p. 87) There is no such function (Theorem 2.3.9).

2.3.24 (p. 87) Counterexample: Let  $x_0 = 0$ ,  $f(x) = |x|^{3/2} \sin(1/x)$  if  $x \neq 0$ , and  $f(0) = 0$ .

2.3.27 (p. 88) Counterexample: Let  $x_0 = 0$ ,  $f(x) = x/|x|$  if  $x \neq 0$ ,  $f(0) = 0$ .

### Section 2.4 pp. 96–98

2.4.2 (p. 96) 1 2.4.3 (p. 96)  $\frac{1}{2}$  2.4.4 (p. 96)  $\infty$  2.4.5 (p. 96)  $(-1)^{n-1}n$

2.4.6 (p. 96) 1 2.4.7 (p. 96) 0 2.4.8 (p. 96) 1 2.4.9 (p. 96) 0

2.4.10 (p. 96) 0 2.4.11 (p. 96) 0 2.4.12 (p. 96)  $-\infty$  2.4.13 (p. 96) 0

2.4.14 (p. 96)  $-\frac{1}{2}$  2.4.15 (p. 96) 0 2.4.16 (p. 96) 0 2.4.17 (p. 96) 1

2.4.18 (p. 96) 1 2.4.19 (p. 96) 1 2.4.20 (p. 96)  $e$  2.4.21 (p. 96) 1

2.4.24 (p. 96)  $1/e$  2.4.22 (p. 96) 0

2.4.23 (p. 96)  $-\infty$  if  $\alpha \leq 0$ , 0 if  $\alpha > 0$

2.4.25 (p. 96)  $e^2$  2.4.26 (p. 96) 1 2.4.27 (p. 96) 0 2.4.28 (p. 96) 0

2.4.29 (p. 96)  $\infty$  if  $\alpha > 0$ ,  $-\infty$  if  $\alpha \leq 0$

2.4.30 (p. 96)  $\infty$  2.4.31 (p. 97) 1 2.4.32 (p. 97)  $1/120$  2.4.33 (p. 97)  $\infty$

2.4.34 (p. 97)  $-\infty$  2.4.35 (p. 97)  $-\infty$  if  $\alpha \leq 0$ , 0 if  $\alpha > 0$

2.4.36 (p. 97)  $\infty$  2.4.37 (p. 97) 1 2.4.38 (p. 97) 0 2.4.39 (p. 97) 0

2.4.40 (p. 97) 0 2.4.41 (p. 97) (b) Suppose that  $g'$  is continuous at  $x_0$  and  $f(x) = g(x)$  if  $x \leq x_0$ ,  $f(x) = 1 + g(x)$  if  $x > x_0$ .

2.4.44 (p. 97) (a) 1 (b)  $e$  (c) 1 2.4.45 (p. 98)  $e^L$

Section 2.5 pp. 107–112

2.5.2 (p. 107)  $f^{(n+1)}(x_0)/(n+1)!$ . 2.5.4 (p. 107) (b) Counterexample: Let  $x_0 = 0$  and  $f(x) = x|x|$ .

2.5.5 (p. 108) (b) Let  $g(x) = 1 + |x - x_0|$ , so  $f(x) = (x - x_0)(1 + |x - x_0|)$ .

2.5.6 (p. 108) (b) Let  $g(x) = 1 + |x - x_0|$ , so  $f(x) = (x - x_0)^2(1 + |x - x_0|)$ .

2.5.10 (p. 109) (b) (i) 1, 2, 2, 0 (ii) 0,  $-\pi$ ,  $3\pi/2$ ,  $-4\pi + \pi^3/2$   
(iii)  $-\pi^2/4$ ,  $-2\pi$ ,  $-6 + \pi^2/4$ ,  $4\pi$  (iv)  $-2$ , 5,  $-16$ , 65

2.5.11 (p. 109) (b) 0,  $-1$ , 0, 5

2.5.12 (p. 110) (b) (i) 0, 1, 0, 5 (ii)  $-1$ , 0, 6,  $-24$  (iii)  $\sqrt{2}$ ,  $3\sqrt{2}$ ,  $11\sqrt{2}$ ,  $57\sqrt{2}$  (iv)  $-1$ , 3,  $-14$ , 88 (a) min (b) neither (c) min (d) max (e) min (f) neither (g) min (h) min

2.5.14 (p. 110)  $f(x) = e^{-1/x^2}$  if  $x \neq 0$ ,  $f(0) = 0$  (Exercise 2.5.1 (p. 107))

2.5.15 (p. 111) None if  $b^2 - 4c < 0$ ; local min at  $x_1 = (-b + \sqrt{b^2 - 4c})/2$  and local max at  $x_1 = (-b - \sqrt{b^2 - 4c})/2$  if  $b^2 - 4c > 0$ ; if  $b^2 = 4c$  then  $x = -b/2$  is a critical point, but not a local extreme point.

2.5.16 (p. 111) (a)  $\frac{1}{6} \left(\frac{\pi}{20}\right)^3$  (b)  $\frac{1}{8^3}$  (c)  $\frac{\pi^2}{512\sqrt{2}}$  (d)  $\frac{1}{4(63)^4}$

2.5.20 (p. 112) (a)  $M_3h/3$ , where  $M_3 = \sup_{|x-c|\leq h} |f^{(3)}(c)|$   
(b)  $M_4h^2/12$  where  $M_4 = \sup_{|x-c|\leq h} |f^{(4)}(c)|$

2.5.21 (p. 112)  $k = -h/2$

Section 3.1 pp. 125–128

3.1.8 (p. 126) (b) monotonic functions (c) Let  $[a, b] = [0, 1]$  and  $P = \{0, 1\}$ . Let  $f(0) = f(1) = \frac{1}{2}$  and  $f(x) = x$  if  $0 < x < 1$ . Then  $s(P) = 0$  and  $S(P) = 1$ , but neither is a Riemann sum of  $f$  over  $P$ .

3.1.9 (p. 127) (a)  $\frac{1}{2}$ ,  $-\frac{1}{2}$  (b)  $\frac{1}{2}$ , 1 3.1.10 (p. 127)  $e^b - e^a$  3.1.11 (p. 127)  $1 - \cos b$  3.1.12 (p. 127)  $\sin b$

3.1.14 (p. 127)  $f(a)[g_1 - g(a)] + f(d)(g_2 - g_1) + f(b)[g(b) - g_2]$

3.1.15 (p. 127)  $f(a)[g_1 - g(a)] + f(b)[g(b) - g_p] + \sum_{m=1}^{p-1} f(a_m)(g_{m+1} - g_m)$

3.1.16 (p. 127) (a) If  $g \equiv 1$  and  $f$  is arbitrary, then  $\int_a^b f(x) dg(x) = 0$ .

Section 3.3 pp. 149–151

3.3.7 (p. 150) (a)  $\bar{u} = c = \frac{2}{3}$  (b)  $\bar{u} = c = 0$  (c)  $\bar{u} = (e - 2)/(e - 1)$ ,  $c = \sqrt{\bar{u}}$

## Section 3.4 pp. 165–171

## 3.4.4 (p. 166)

- (a) (i)  $p \geq 2$  (ii)  $p > 0$  (iii) 0  
 (b) (i)  $p \geq 2$  (ii)  $p > 0$  (iii) 0  
 (c) (i) none (ii)  $p > 0$  (iii)  $1/p$   
 (d) (i)  $p \leq 0$  (ii)  $0 < p < 1$  (iii)  $1/(1-p)$   
 (e) (i) none (ii) none

3.4.5 (p. 166) (a)  $n!$  (b)  $\frac{1}{2}$  (c) divergent (d) 1 (e)  $-1$  (f) 0

3.4.8 (p. 166) (a) divergent (b) convergent (c) divergent (d) convergent (e) convergent (f) divergent

3.4.9 (p. 166) (a)  $p < 2$  (b)  $p < 1$  (c)  $p > -1$  (d)  $-1 < p < 2$  (e) none (f) none (g)  $p < 1$ 3.4.11 (p. 167) (a)  $p - q < 1$  (b)  $p, q < 1$  (c)  $-1 < p < 2q - 1$  (d)  $q > -1$ ,  $p + q > 1$  (e)  $p + q > 1$  (f)  $q + 1 < p < 3q + 1$ 3.4.12 (p. 167)  $\deg g - \deg f \geq 2$ 

## 3.4.18 (p. 168)

- (a) (i)  $p > 1$  (ii)  $0 < p \leq 1$   
 (b) (i)  $p > 1$  (ii)  $p \leq 1$   
 (c) (i)  $p > 1$  (ii)  $0 \leq p \leq 1$   
 (d) (i)  $p > 0$  (ii) none  
 (e) (i)  $1 < p < 4$  (ii)  $0 < p \leq 1$   
 (f) (i)  $p > \frac{1}{2}$  (ii)  $0 < p \leq \frac{1}{2}$

## 3.4.25 (p. 169)

- (a) (i)  $p > -1$  (ii)  $-2 < p \leq -1$   
 (b) (i)  $p > -1$  (ii) none  
 (c) (i)  $p < -1$  (ii) none  
 (d) (i) none (ii) none  
 (e) (i)  $p < -1$  (ii)  $p > 1$

## Section 4.1 pp. 192–195

4.1.3 (p. 192) (a) 2 (b) 1 (c) 0 4.1.4 (p. 192) (a)  $1/2$  (b)  $1/2$  (c)  $1/2$  (d)  $1/2$ 4.1.11 (p. 192) (d)  $\sqrt{A}$  4.1.14 (p. 193) (a) 1 (b) 1 (c) 1 (d)  $-\infty$  (e) 04.1.22 (p. 193) If  $s_n = 1$  and  $t_n = -1/n$ , then  $(\lim_{n \rightarrow \infty} s_n)/(\lim_{n \rightarrow \infty} t_n) = 1/0 = \infty$ , but  $\lim_{n \rightarrow \infty} s_n/t_n = -\infty$ .4.1.24 (p. 193) (a)  $\infty, 0$  (b)  $\infty, -\infty$  if  $|r| > 1$ ; 2,  $-2$  if  $r = -1$ ; 0, 0 if  $r = 1$ ; 1,  $-1$  if  $|r| < 1$  (c)  $\infty, -\infty$  if  $r < -1$ ; 0, 0 if  $|r| < 1$ ;  $\frac{1}{2}, \frac{1}{2}$  if  $r = 1$ ;  $\infty, \infty$  if  $r > 1$  (d)  $\infty, \infty$  (e)  $|t|, -|t|$

4.1.25 (p. 194) (a) 1, -1 (b) 2, -2 (c) 3, -1 (d)  $\sqrt{3}/2, -\sqrt{3}/2$

4.1.34 (p. 194) (b) If  $\{s_n\} = \{1, 0, 1, 0, \dots\}$ , then  $\lim_{n \rightarrow \infty} t_n = \frac{1}{2}$

### Section 4.2 pp. 199–200

4.2.2 (p. 199) (a)  $\lim_{m \rightarrow \infty} s_{2m} = \infty, \lim_{m \rightarrow \infty} s_{2m+1} = -\infty$

(b)  $\lim_{m \rightarrow \infty} s_{4m} = 1, \lim_{m \rightarrow \infty} s_{4m+2} = -1, \lim_{m \rightarrow \infty} s_{2m+1} = 0$

(c)  $\lim_{m \rightarrow \infty} s_{2m} = 0, \lim_{m \rightarrow \infty} s_{4m+1} = 1, \lim_{m \rightarrow \infty} s_{4m+3} = -1$

(d)  $\lim_{n \rightarrow \infty} s_n = 0$  (e)  $\lim_{m \rightarrow \infty} s_{2m} = \infty, \lim_{m \rightarrow \infty} s_{2m+1} = 0$

(f)  $\lim_{m \rightarrow \infty} s_{8m} = \lim_{m \rightarrow \infty} s_{8m+2} = 1, \lim_{m \rightarrow \infty} s_{8m+1} = \sqrt{2},$

$\lim_{m \rightarrow \infty} s_{8m+3} = \lim_{m \rightarrow \infty} s_{8m+7} = 0, \lim_{m \rightarrow \infty} s_{8m+5} = -\sqrt{2},$

$\lim_{m \rightarrow \infty} s_{8m+4} = \lim_{m \rightarrow \infty} s_{8m+6} = -1$

4.2.3 (p. 199)  $\{1, 2, 1, 2, 3, 1, 2, 3, 4, 1, 2, 3, 4, 5, \dots\}$

4.2.8 (p. 200) Let  $\{t_n\}$  be any convergent sequence and  $\{s_n\} = \{t_1, 1, t_2, 2, \dots, t_n, n, \dots\}$ .

### Section 4.3 pp. 228–234

4.3.4 (p. 229) (b) No; consider  $\sum 1/n$

4.3.8 (p. 229) (a) convergent (b) convergent (c) divergent (d) divergent

(e) convergent (f) convergent (g) divergent (h) convergent

4.3.10 (p. 229) (a)  $p > 1$  (b)  $p > 1$  (c)  $p > 1$

4.3.15 (p. 230) (a) convergent (b) convergent if  $0 < r < 1$ , divergent if  $r \geq 1$

(c) divergent (d) convergent (e) divergent (f) convergent

4.3.17 (p. 231) (a) convergent (b) convergent (c) convergent (d) convergent

4.3.18 (p. 231) (a) divergent (b) convergent if and only if  $0 < r < 1$  or  $r = 1$  and  $p < -1$  (c) convergent (d) convergent (e) convergent

4.3.19 (p. 231) (a) divergent (b) convergent (c) convergent (d) convergent if  $\alpha < \beta - 1$ , divergent if  $\alpha \geq \beta - 1$

4.3.20 (p. 231) (a) divergent (b) convergent (c) convergent (d) convergent

4.3.21 (p. 231) (a)  $\sum (-1)^n$  (b)  $\sum (-1)^n/n, \sum \left[ \frac{(-1)^n}{n} + \frac{1}{n \log n} \right]$

(c)  $\sum (-1)^n 2^n$  (d)  $\sum (-1)^n$

4.3.27 (p. 232) (a) conditionally convergent (b) conditionally convergent (c) absolutely convergent (d) absolutely convergent

4.3.28 (p. 232) Let  $k$  and  $s$  be the degrees of the numerator and denominator, respectively. If  $|r| = 1$ , the series converges absolutely if and only if  $s \geq k + 2$ . The series converges conditionally if  $s = k + 1$  and  $r = -1$ , and diverges in all other cases, where  $s \geq k + 1$  and  $|r| = 1$ .

4.3.30 (p. 232) (b)  $\sum (-1)^n/\sqrt{n}$  4.3.41 (p. 233) (a) 0 (b)  $2A - a_0$

## Section 4.4 pp. 253–256

4.4.1 (p. 253) (a)  $F(x) = 0, |x| \leq 1$  (b)  $F(x) = 0, |x| \leq 1$ (c)  $F(x) = 0, -1 < x \leq 1$  (d)  $F(x) = \sin x, -\infty < x < \infty$ (e)  $F(x) = 1, -1 < x \leq 1; F(x) = 0, |x| > 1$  (f)  $F(x) = x, -\infty < x < \infty$ (g)  $F(x) = x^2/2, -\infty < x < \infty$  (h)  $F(x) = 0, -\infty < x < \infty$ (i)  $F(x) = 1, -\infty < x < \infty$ 4.4.5 (p. 254) (a)  $F(x) = 0$  (b)  $F(x) = 1, |x| < 1; F(x) = 0, |x| > 1$ (c)  $F(x) = \sin x/x$ 4.4.6 (p. 254) (c)  $F_n(x) = x^n; S_k = [-k/(k+1), k/(k+1)]$ 4.4.7 (p. 254) (a)  $[-1, 1]$  (b)  $[-r, r] \cup \{1\} \cup \{-1\}, 0 < r < 1$  (c)  $[-r, r] \cup \{1\}, 0 < r < 1$ (d)  $[-r, r], r > 0$  (e)  $(-\infty, -1/r] \cup [-r, r] \cup [1/r, \infty) \cup \{1\}, 0 < r < 1$ (f)  $[-r, r], r > 0$  (g)  $[-r, r], r > 0$  (h)  $(-\infty, -r] \cup [r, \infty) \cup \{0\}, r > 0$ (i)  $[-r, r], r > 0$ 4.4.12 (p. 254) (b) Let  $S = (0, 1]$ ,  $F_n(x) = \sin(x/n)$ ,  $G_n(x) = 1/x^2$ ; then  $F = 0$ ,  $G = 1/x^2$ , and the convergence is uniform, but  $\|F_n G_n\|_S = \infty$ .4.4.14 (p. 255) (a) 3 (b) 1 (c)  $\frac{1}{2}$  (d)  $e - 1$ 4.4.17 (p. 255) (a) compact subsets of  $(-\frac{1}{2}, \infty)$  (b)  $[-\frac{1}{2}, \infty)$  (c) closed subsetsof  $(-\infty, 0) \cup (0, \infty)$   
sets of  $(\frac{1-\sqrt{5}}{2}, \frac{1+\sqrt{5}}{2})$  (d)  $(-\infty, \infty)$  (e)  $[r, \infty), r > 1$  (f) compact subsets4.4.19 (p. 255) (a) Let  $S = (-\infty, \infty)$ ,  $f_n = a_n$  (constant), where  $\sum a_n$  converges conditionally, and  $g_n = |a_n|$ . (b) “absolutely”4.4.20 (p. 255) (a) (i) means that  $\sum |f_n(x)|$  converges pointwise and  $\sum f_n(x)$  converges uniformly on  $S$ , while (ii) means that  $\sum |f_n(x)|$  converges uniformly on  $S$ .4.4.27 (p. 256) (a)  $\sum_{n=0}^{\infty} (-1)^n \frac{x^{2n+1}}{n!(2n+1)}$  (b)  $\sum_{n=0}^{\infty} (-1)^n \frac{x^{2n+1}}{(2n+1)(2n+1)!}$ 

## Section 4.5 pp. 275–280

4.5.2 (p. 276) (a)  $1/3e$  (b) 1 (c)  $\frac{1}{3}$  (d) 1 (e)  $\infty$ 4.5.8 (p. 276) (a) 1 (b)  $\frac{1}{2}$  (c)  $\frac{1}{4}$  (d) 4 (e)  $1/e$  (f) 14.5.10 (p. 277)  $x(1+x)/(1-x)^3$  4.5.12 (p. 277)  $e^{-x^2}$ 4.5.16 (p. 277)  $\sum_{n=1}^{\infty} \frac{(-1)^{n-1}}{n^2} (x-1)^n; R = 1$ 4.5.17 (p. 277)  $\tan^{-1} x = \sum_{n=0}^{\infty} (-1)^n \frac{x^{2n+1}}{(2n+1)}$ ;  $f^{(2n)}(0) = 0$ ;  $f^{(2n+1)}(0) = (-1)^2(2n)!$ ;

$$\frac{\pi}{6} = \tan^{-1} \frac{1}{\sqrt{3}} = \sum_{n=0}^{\infty} \frac{(-1)^n}{(2n+1)3^{n+1/2}}$$

$$4.5.22 \text{ (p. 278) } \cosh x = \sum_{n=0}^{\infty} \frac{x^{2n}}{(2n)!}, \sinh x = \sum_{n=0}^{\infty} \frac{x^{2n+1}}{(2n+1)!}$$

4.5.23 (p. 278)  $(1-x) \sum_{n=0}^{\infty} x^n = 1$  converges for all  $x$

$$4.5.24 \text{ (p. 278) (a) } x + x^2 + \frac{x^3}{3} - \frac{3x^5}{40} + \dots \text{ (b) } 1 - x - \frac{x^2}{2} + \frac{5x^3}{6} + \dots \text{ (c)}$$

$$1 - \frac{x^2}{2} + \frac{x^4}{24} - \frac{721x^6}{720} + \dots \text{ (d) } x^2 - \frac{x^3}{2} + \frac{x^4}{6} - \frac{x^5}{6} + \dots$$

$$4.5.27 \text{ (p. 279) (a) } 1 + x + \frac{2x^2}{3} + \frac{x^3}{3} + \dots \text{ (b) } 1 - x - \frac{x^2}{2} + \frac{3x^3}{2} + \dots \text{ (c) } 1 + \frac{x^2}{2} + \frac{5x^4}{24} + \frac{61x^6}{720} + \dots$$

$$\text{(d) } 1 + \frac{x^2}{6} + \frac{7x^4}{360} + \frac{31x^6}{15120} + \dots \text{ (e) } 2 - x^2 + \frac{x^4}{12} - \frac{x^6}{360} + \dots$$

$$4.5.28 \text{ (p. 279) } F(x) = \frac{5}{(1-3x)(1+2x)} = \frac{3}{1-3x} + \frac{2}{1+2x} = \sum_{n=0}^{\infty} [3^{n+1} - (-2)^{n+1}]x^n$$

4.5.29 (p. 279) 1

## Section 5.1 pp. 299–302

$$5.1.1 \text{ (p. 299) (a) } (3, 0, 3, 3) \text{ (b) } (-1, -1, 4) \text{ (c) } (\frac{1}{6}, \frac{11}{12}, \frac{23}{24}, \frac{5}{36})$$

$$5.1.3 \text{ (p. 299) (a) } \sqrt{15} \text{ (b) } \sqrt{65}/12 \text{ (c) } \sqrt{31} \text{ (d) } \sqrt{3}$$

$$5.1.4 \text{ (p. 299) (a) } \sqrt{89} \text{ (b) } \sqrt{166}/12 \text{ (c) } 3 \text{ (d) } \sqrt{31}$$

$$5.1.5 \text{ (p. 299) (a) } 12 \text{ (b) } \frac{1}{32} \text{ (c) } 27$$

5.1.7 (p. 299)  $\mathbf{X} = \mathbf{X}_0 + t\mathbf{U}$  ( $-\infty < t < \infty$ ) in all cases.

5.1.8 (p. 299)  $\dots \mathbf{U}$  and  $\mathbf{X}_1 - \mathbf{X}_0$  are scalar multiples of  $\mathbf{V}$ .

$$5.1.9 \text{ (p. 299) (a) } \mathbf{X} = (1, -3, 4, 2) + t(1, 3, -5, 3)$$

$$\text{(b) } \mathbf{X} = (3, 1, -2, 1, 4) + t(-1, -1, 1, 3, -7)$$

$$\text{(c) } \mathbf{X} = (1, 2, -1) + t(-1, -3, 0)$$

$$5.1.10 \text{ (p. 300) (a) } 5 \text{ (b) } 2 \text{ (c) } 1/2\sqrt{5}$$

$$5.1.11 \text{ (p. 300) (a) (i) } \{(x_1, x_2, x_3, x_4) \mid |x_i| \leq 3 \text{ (} i = 1, 2, 3) \text{ with at least one equality}\}$$

$$\text{(ii) } \{(x_1, x_2, x_3, x_4) \mid |x_i| \leq 3 \text{ (} i = 1, 2, 3)\} \text{ (iii) } S$$

$$\text{(iv) } \{(x_1, x_2, x_3, x_4) \mid |x_i| > 3 \text{ for at least one of } i = 1, 2, 3\}$$

$$\text{(b) (i) } S \text{ (ii) } S \text{ (iii) } \emptyset \text{ (iv) } \{(x, y, z) \mid z \neq 1 \text{ or } x^2 + y^2 > 1\}$$

5.1.12 (p. 300) (a) open (b) neither (c) closed

$$5.1.18 \text{ (p. 300) (a) } (\pi, 1, 0) \text{ (b) } (1, 0, e)$$

$$5.1.19 \text{ (p. 300) (a) } 6 \text{ (b) } 6 \text{ (c) } 2\sqrt{5} \text{ (d) } 2L\sqrt{n} \text{ (e) } \infty$$

$$5.1.29 \text{ (p. 302) } \{(x, y) \mid x^2 + y^2 = 1\}$$

5.1.33 (p. 302) ... if for  $A$  there is an integer  $R$  such that  $|\mathbf{X}_r| > A$  if  $r \geq R$ .

Section 5.2 pp. 314–316

5.2.1 (p. 314) (a) 10 (b) 3 (c) 1 (d) 0 (e) 0 (f) 0

5.2.3 (p. 315) (b)  $a/(1+a^2)$

5.2.4 (p. 315) (a)  $\infty$  (b)  $\infty$  (c) no (d)  $-\infty$  (e) no

5.2.5 (p. 315) (a) 0 (b) 0 (c) none (d) 0 (e) none

5.2.6 (p. 316) (a) ... if  $D_f$  is unbounded and for each  $M$  there is an  $R$  such that  $f(\mathbf{X}) > M$  if  $\mathbf{X} \in D_f$  and  $|\mathbf{X}| > R$ . (b) Replace “ $> M$ ” by “ $< M$ ” in (a).

5.2.7 (p. 316)  $\lim_{\mathbf{X} \rightarrow 0} f(\mathbf{X}) = 0$  if  $a_1 + a_2 + \cdots + a_n > b$ ; no limit if  $a_1 + a_2 + \cdots + a_n \leq b$  and  $a_1^2 + a_2^2 + \cdots + a_n^2 \neq 0$ ;  $\lim_{\mathbf{X} \rightarrow 0} f(\mathbf{X}) = \infty$  if  $a_1 = a_2 = \cdots = a_n = 0$  and  $b > 0$ .

5.2.8 (p. 316) No; for example,  $\lim_{x \rightarrow \infty} g(x, \sqrt{x}) = 0$ .

5.2.9 (p. 316) (a)  $\mathbb{R}^3$  (b)  $\mathbb{R}^2$  (c)  $\mathbb{R}^3$  (d)  $\mathbb{R}^2$  (e)  $\{(x, y) \mid x \geq y\}$  (f)  $\mathbb{R}^n$

5.2.10 (p. 316) (a)  $\mathbb{R}^3 - \{(0, 0, 0)\}$  (b)  $\mathbb{R}^2$  (c)  $\mathbb{R}^2$  (d)  $\mathbb{R}^2$  (e)  $\mathbb{R}^2$

5.2.11 (p. 316)  $f(x, y) = xy/(x^2 + y^2)$  if  $(x, y) \neq (0, 0)$  and  $f(0, 0) = 0$

Section 5.3 pp. 335–339

5.3.1 (p. 335) (a)  $\frac{2}{\sqrt{3}}(x + y \cos x - xy \sin x) - 2\sqrt{\frac{2}{3}}(x \cos x)$  (b)  $\frac{1-2y}{\sqrt{3}}e^{-x+y^2+2z}$   
 (c)  $\frac{2}{\sqrt{n}}(x_1 + x_2 + \cdots + x_n)$  (d)  $1/(1+x+y+z)$

5.3.2 (p. 335)  $\phi_1^2 \phi_2$  5.3.3 (p. 335) (a)  $-5\pi/\sqrt{6}$  (b)  $-2e$  (c) 0 (d) 0

5.3.5 (p. 335) (a)  $f_x = f_y = 1/(x + y + 2z)$ ,  $f_z = 2/(x + y + 2z)$

(b)  $f_x = 2x + 3yz + 2y$ ,  $f_y = 3xz + 2x$ ,  $f_z = 3xy$  (c)  $f_x = e^{yz}$ ,  $f_y = xze^{yz}$ ,  $f_z = xye^{yz}$  (d)  $f_x = 2xy \cos x^2 y$ ,  $f_y = x^2 \cos x^2 y$ ,  $f_z = 1$

5.3.6 (p. 335) (a)  $f_{xx} = f_{yy} = f_{xy} = f_{yx} = -1/(x + y + 2z)^2$ ,  $f_{xz} = f_{zx} = f_{yz} = f_{zy} = -2/(x + y + 2z)^2$ ,  $f_{zz} = -4/(x + y + 2z)^2$

(b)  $f_{xx} = 2$ ,  $f_{yy} = f_{zz} = 0$ ,  $f_{xy} = f_{yx} = 3z + 2$ ,  $f_{xz} = f_{zx} = 3y$ ,  $f_{yz} = f_{zy} = 3x$

(c)  $f_{xx} = 0$ ,  $f_{yy} = xz^2 e^{yz}$ ,  $f_{zz} = xy^2 e^{yz}$ ,  $f_{xy} = f_{yx} = ze^{yz}$ ,  $f_{xz} = f_{zx} = ye^{yz}$ ,  $f_{yz} = f_{zy} = xe^{yz}$

(d)  $f_{xx} = 2y \cos x^2 y - 4x^2 y^2 \sin x^2 y$ ,  $f_{yy} = -x^4 \sin x^2 y$ ,  $f_{zz} = 0$ ,  $f_{xy} = f_{yx} = 2x \cos x^2 y - 2x^3 y \sin x^2 y$ ,  $f_{xz} = f_{zx} = f_{yz} = f_{zy} = 0$

5.3.7 (p. 336) (a)  $f_{xx}(0, 0) = f_{yy}(0, 0) = 0$ ,  $f_{xy}(0, 0) = -1$ ,  $f_{yx}(0, 0) = 1$

(b)  $f_{xx}(0, 0) = f_{yy}(0, 0) = 0$ ,  $f_{xy}(0, 0) = -1$ ,  $f_{yx}(0, 0) = 1$

5.3.8 (p. 336)  $f(x, y) = g(x, y) + h(y)$ , where  $g_{xy}$  exists everywhere and  $h$  is nowhere differentiable.

**5.3.18 (p. 337)** (a)  $df = (3x^2 + 4y^2 + 2y \sin x + 2xy \cos x) dx + (8xy + 2x \sin x) dy$ ,  
 $d_{\mathbf{X}_0} f = 16 dx$ ,  $(d_{\mathbf{X}_0} f)(\mathbf{X} - \mathbf{X}_0) = 16x$

(b)  $df = -e^{-x-y-z} (dx + dy + dz)$ ,  $d_{\mathbf{X}_0} f = -dx - dy - dz$ ,  
 $(d_{\mathbf{X}_0} f)(\mathbf{X} - \mathbf{X}_0) = -x - y - z$

(c)  $df = (1 + x_1 + 2x_2 + \cdots + nx_n)^{-1} \sum_{j=1}^n j dx_j$ ,  $d_{\mathbf{X}_0} f = \sum_{j=1}^n j dx_j$ ,  
 $(d_{\mathbf{X}_0} f)(\mathbf{X} - \mathbf{X}_0) = \sum_{j=1}^n j x_j$ ,

(d)  $df = 2r|\mathbf{X}|^{2r-2} \sum_{j=1}^n x_j dx_j$ ,  $d_{\mathbf{X}_0} f = 2rn^{r-1} \sum_{j=1}^n dx_j$ ,  
 $(d_{\mathbf{X}_0} f)(\mathbf{X} - \mathbf{X}_0) = 2rn^{r-1} \sum_{j=1}^n (x_j - 1)$ ,

**5.3.19 (p. 337)** (b) The unit vector in the direction of  $(f_{x_1}(\mathbf{X}_0), f_{x_2}(\mathbf{X}_0), \dots, f_{x_n}(\mathbf{X}_0))$  provided that this is not  $\mathbf{0}$ ; if it is  $\mathbf{0}$ , then  $\partial f(\mathbf{X}_0)/\partial \Phi = 0$  for every  $\Phi$ .

**5.3.24 (p. 338)** (a)  $z = 2x + 4y - 6$  (b)  $z = 2x + 3y + 1$  (c)  $z = (\pi x)/2 + y - \pi/2$   
 (d)  $z = x + 10y + 4$

**Section 5.4 pp. 356–360**

**5.4.2 (p. 357)** (a)  $5 du + 34 dv$  (b)  $0$  (c)  $6 du - 18 dv$  (d)  $8 du$

**5.4.3 (p. 357)**  $h_r = f_x \cos \theta + f_y \sin \theta$ ,  $h_\theta = r(-f_x \sin \theta + f_y \cos \theta)$ ,  $h_z = f_z$

**5.4.4 (p. 357)**  $h_r = f_x \sin \phi \cos \theta + f_y \sin \phi \sin \theta + f_z \cos \phi$ ,  $h_\theta = r \sin \phi (-f_x \sin \theta + f_y \cos \theta)$ ,  
 $h_\phi = r(f_x \cos \phi \cos \theta + f_y \cos \phi \sin \theta - f_z \sin \phi)$

**5.4.6 (p. 357)**  $h_y = g_x x_y + g_y + g_w w_y$ ,  $h_z = g_x x_z + g_z + g_w w_z$

**5.4.13 (p. 358)**  $h_{rr} = f_{xx} \sin^2 \phi \cos^2 \theta + f_{yy} \sin^2 \phi \sin^2 \theta + f_{zz} \cos^2 \phi + f_{xy} \sin^2 \phi \sin 2\theta + f_{yz} \sin 2\phi \sin \theta + f_{xz} \sin 2\phi \cos \theta$ ,

$h_{r\theta} = (-f_x \sin \theta + f_y \cos \theta) \sin \phi + \frac{r}{2}(f_{yy} - f_{xx}) \sin^2 \phi \sin 2\theta + r f_{xy} \sin^2 \phi \cos 2\theta + \frac{r}{2}(f_{zy} \cos \theta - f_{zx} \sin \theta) \sin 2\phi$

**5.4.16 (p. 358)** (a)  $1 + x + \frac{x^2}{2} - \frac{y^2}{2} + \frac{x^3}{6} - \frac{xy^2}{2}$

(b)  $1 - x - y + \frac{x^2}{2} + xy + \frac{y^2}{2} - \frac{x^3}{6} - \frac{x^2 y}{2} - \frac{xy^2}{2} - \frac{y^3}{6}$

(c)  $0$  (d)  $xyz$

**5.4.21 (p. 359)** (a)  $(d_{(0,0)}^2 p)(x, y) = (d_{(0,0)}^2 q)(x, y) = 2(x - y)^2$

**Section 6.1 pp. 376–378**

**6.1.3 (p. 376)** (a)  $\begin{bmatrix} 3 & 4 & 6 \\ 2 & -4 & 2 \\ 7 & 2 & 3 \end{bmatrix}$  (b)  $\begin{bmatrix} 2 & 4 \\ 3 & -2 \\ 7 & -4 \\ 6 & 1 \end{bmatrix}$

**6.1.4 (p. 376)** (a)  $\begin{bmatrix} 8 & 8 & 16 & 24 \\ 0 & 0 & 4 & 12 \\ 12 & 16 & 28 & 44 \end{bmatrix}$  (b)  $\begin{bmatrix} -2 & -6 & 0 \\ 0 & -2 & -4 \\ -2 & 2 & -6 \end{bmatrix}$



$$6.1.5 \text{ (p. 376) (a) } \begin{bmatrix} -2 & 2 & 6 \\ 6 & 7 & -3 \\ 0 & -2 & 6 \end{bmatrix} \quad \text{(b) } \begin{bmatrix} -1 & 7 \\ 3 & 5 \\ 5 & 14 \end{bmatrix}$$

$$6.1.6 \text{ (p. 376) (a) } \begin{bmatrix} 13 & 25 \\ 16 & 31 \\ 16 & 25 \end{bmatrix} \quad \text{(b) } \begin{bmatrix} 29 \\ 50 \end{bmatrix}$$

6.1.10 (p. 377) **A** and **B** are square of the same order.

$$6.1.12 \text{ (p. 377) (a) } \begin{bmatrix} 7 & 3 & 3 \\ 4 & 7 & 7 \\ 6 & -9 & 1 \end{bmatrix} \quad \text{(b) } \begin{bmatrix} 14 & 10 \\ 6 & -2 \\ 14 & 2 \end{bmatrix}$$

$$6.1.13 \text{ (p. 377) } \begin{bmatrix} -7 & 6 & 4 \\ -9 & 7 & 13 \\ 5 & 0 & -14 \end{bmatrix}, \quad \begin{bmatrix} -5 & 6 & 0 \\ 4 & -12 & 3 \\ 4 & 0 & 3 \end{bmatrix}$$

$$6.1.15 \text{ (p. 377) (a) } [6xyz \quad 3xz^2 \quad 3x^2y]; [-6 \quad 3 \quad -3]$$

$$\text{(b) } \cos(x+y) \begin{bmatrix} 1 & 1 \\ 0 & 0 \end{bmatrix}$$

$$\text{(c) } [(1-xz)ye^{-xz} \quad xe^{-xz} \quad -x^2ye^{-xz}]; [2 \quad 1 \quad -2]$$

$$\text{(d) } \sec^2(x+2y+z) \begin{bmatrix} 1 & 2 & 1 \\ 2 & 4 & 2 \end{bmatrix}$$

$$\text{(e) } |\mathbf{X}|^{-1} [x_1 \quad x_2 \quad \cdots \quad x_n]; \frac{1}{\sqrt{n}} [1 \quad 1 \quad \cdots \quad 1]$$

$$6.1.20 \text{ (p. 377) (a) } (2, 3, -2) \quad \text{(b) } (2, 3, 0) \quad \text{(c) } (-2, 0, -1) \quad \text{(d) } (3, 1, 3, 2)$$

$$6.1.21 \text{ (p. 378) (a) } \frac{1}{10} \begin{bmatrix} 4 & 2 \\ -3 & 1 \end{bmatrix} \quad \text{(b) } \frac{1}{2} \begin{bmatrix} -1 & 1 & 2 \\ 3 & 1 & -4 \\ -1 & -1 & 2 \end{bmatrix}$$

$$\text{(c) } \frac{1}{25} \begin{bmatrix} 4 & 3 & -5 \\ 6 & -8 & 5 \\ -3 & 4 & 10 \end{bmatrix} \quad \text{(d) } \frac{1}{2} \begin{bmatrix} 1 & -1 & 1 \\ -1 & 1 & 1 \\ 1 & 1 & -1 \end{bmatrix}$$

$$\text{(e) } \frac{1}{7} \begin{bmatrix} 3 & -2 & 0 & 0 \\ 2 & 1 & 0 & 0 \\ 0 & 0 & 2 & -3 \\ 0 & 0 & 1 & 2 \end{bmatrix} \quad \text{(f) } \frac{1}{10} \begin{bmatrix} -1 & -2 & 0 & 5 \\ -14 & -18 & 10 & 20 \\ 21 & 22 & -10 & -25 \\ 17 & 24 & -10 & -25 \end{bmatrix}$$

## Section 6.2 pp. 390–394

$$6.2.12 \text{ (p. 392) (a) } \mathbf{F}'(\mathbf{X}) = \begin{bmatrix} 2x & 1 & 2 \\ -\sin(x+y+z) & -\sin(x+y+z) & -\sin(x+y+z) \\ yze^{xyz} & xze^{xyz} & xye^{xyz} \end{bmatrix};$$

$$J\mathbf{F}(\mathbf{X}) = e^{xyz} \sin(x+y+z)[x(1-2x)(y-z) - z(x-y)];$$

$$\mathbf{G}(\mathbf{X}) = \begin{bmatrix} 0 \\ 1 \\ 1 \end{bmatrix} + \begin{bmatrix} 2 & 1 & 2 \\ 0 & 0 & 0 \\ 0 & 0 & -1 \end{bmatrix} \begin{bmatrix} x-1 \\ y+1 \\ z \end{bmatrix}$$

$$\text{(b) } \mathbf{F}'(\mathbf{X}) = \begin{bmatrix} e^x \cos y & -e^x \sin y \\ e^x \sin y & e^x \cos y \end{bmatrix}; \quad J\mathbf{F}(\mathbf{X}) = e^{2x};$$

$$\mathbf{G}(\mathbf{X}) = \begin{bmatrix} 0 \\ 1 \end{bmatrix} + \begin{bmatrix} 0 & -1 \\ 1 & 0 \end{bmatrix} \begin{bmatrix} x \\ y - \pi/2 \end{bmatrix}$$

$$\text{(c) } \mathbf{F}'(\mathbf{X}) = \begin{bmatrix} 2x & -2y & 0 \\ 0 & 2y & -2z \\ -2x & 0 & 2z \end{bmatrix}; \quad J\mathbf{F} = 0;$$

$$\mathbf{G}(\mathbf{X}) = \begin{bmatrix} 2 & -2 & 0 \\ 0 & 2 & -2 \\ -2 & 0 & 2 \end{bmatrix} \begin{bmatrix} x-1 \\ y-1 \\ z-1 \end{bmatrix}$$

$$\text{6.2.13 (p. 392) (a) } \mathbf{F}'(\mathbf{X}) = \begin{bmatrix} (x+y+z+1)e^x & e^x & e^x \\ (2x-x^2-y^2)e^{-x} & 2ye^{-x} & 0 \end{bmatrix}$$

$$\text{(b) } \mathbf{F}'(\mathbf{X}) = \begin{bmatrix} g'_1(x) \\ g'_2(x) \\ \vdots \\ g'_n(x) \end{bmatrix}$$

$$\text{(c) } \mathbf{F}'(r, \theta) = \begin{bmatrix} e^x \sin yz & ze^x \cos yz & ye^x \cos yz \\ ze^y \cos xz & e^y \sin xz & xe^y \cos xz \\ ye^z \cos xy & xe^z \cos xy & e^z \sin xy \end{bmatrix}$$

$$\text{6.2.14 (p. 392) (a) } \mathbf{F}'(r, \theta) = \begin{bmatrix} \cos \theta & -r \sin \theta \\ \sin \theta & r \cos \theta \end{bmatrix}; \quad J\mathbf{F}(r, \theta) = r$$

$$\text{(b) } \mathbf{F}'(r, \theta, \phi) = \begin{bmatrix} \cos \theta \cos \phi & -r \sin \theta \cos \phi & -r \cos \theta \sin \phi \\ \sin \theta \cos \phi & r \cos \theta \cos \phi & -r \sin \theta \sin \phi \\ \sin \phi & 0 & r \cos \phi \end{bmatrix};$$

$$J\mathbf{F}(r, \theta, \phi) = r^2 \cos \phi$$

$$\text{(c) } \mathbf{F}'(r, \theta, z) = \begin{bmatrix} \cos \theta & -r \sin \theta & 0 \\ \sin \theta & r \cos \theta & 0 \\ 0 & 0 & 1 \end{bmatrix}; \quad J\mathbf{F}(r, \theta, z) = r$$

$$\text{6.2.20 (p. 393) (a) } \begin{bmatrix} 0 & 0 & 4 \\ 0 & -\frac{1}{2} & 0 \end{bmatrix} \quad \text{(b) } \begin{bmatrix} -18 & 0 \\ 2 & 0 \end{bmatrix} \quad \text{(c) } \begin{bmatrix} 9 & -3 \\ 3 & -8 \\ 1 & 0 \end{bmatrix}$$

$$\text{(d) } \begin{bmatrix} 4 & -3 & 1 \\ 0 & 1 & 1 \end{bmatrix} \quad \text{(e) } \begin{bmatrix} 2 & 0 \\ 2 & 0 \end{bmatrix} \quad \text{(f) } \begin{bmatrix} 5 & 10 \\ 9 & 18 \\ -4 & -8 \end{bmatrix}$$

## Section 6.3 pp. 414–417

6.3.4 (p. 414) (a)  $[1, \pi/2]$  (b)  $[1, 2\pi]$  (c)  $[1, \pi]$  (d)  $[2\sqrt{2}, 9\pi/4]$  (e)  $[\sqrt{2}, 3\pi/4]$

6.3.5 (p. 414) (a)  $[1, -3\pi/2]$  (b)  $[1, -2\pi]$  (c)  $[1, -\pi]$  (d)  $[2\sqrt{2}, -7\pi/4]$  (e)  $[\sqrt{2}, -5\pi/4]$

6.3.6 (p. 414) (b) Let  $f(x) = x$  ( $0 \leq x \leq \frac{1}{2}$ ),  $f(x) = x - \frac{1}{2}$  ( $\frac{1}{2} < x \leq 1$ ); then  $f$  is locally invertible but not invertible on  $[0, 1]$ .

6.3.7 (p. 414)  $\mathbf{F}(S) = \{(u, v) \mid -\pi + 2\phi < \arg(u, v) < \pi + 2\phi\}$ , where  $\phi$  is an argument of  $(a, b)$ ;

$$\mathbf{F}_S^{-1}(u, v) = (u^2 + v^2)^{1/4} \begin{bmatrix} \cos(\arg(u, v)/2) \\ \sin(\arg(u, v)/2) \end{bmatrix}, \quad 2\phi - \pi < \arg(u, v) < 2\phi + \pi$$

6.3.10 (p. 415) (a)  $\begin{bmatrix} x \\ y \end{bmatrix} = \frac{1}{10} \begin{bmatrix} u - 2v \\ 3u + 4v \end{bmatrix}; \quad (\mathbf{F}^{-1})' = \frac{1}{10} \begin{bmatrix} 1 & -2 \\ 3 & 4 \end{bmatrix}$

(b)  $\begin{bmatrix} x \\ y \\ z \end{bmatrix} = \frac{1}{2} \begin{bmatrix} u + 2v + 3w \\ u - w \\ u + v + 2w \end{bmatrix}; \quad (\mathbf{F}^{-1})' = \frac{1}{2} \begin{bmatrix} 1 & 2 & 3 \\ 1 & 0 & -1 \\ 1 & 1 & 2 \end{bmatrix}$

6.3.12 (p. 415)  $\mathbf{G}_1(u, v) = \frac{1}{\sqrt{2}} \begin{bmatrix} \sqrt{u+v} \\ \sqrt{u-v} \end{bmatrix}, \quad \mathbf{G}'_1(u, v) = \frac{1}{2\sqrt{2}} \begin{bmatrix} 1/\sqrt{u+v} & 1/\sqrt{u+v} \\ 1/\sqrt{u-v} & -1/\sqrt{u-v} \end{bmatrix}$

$\mathbf{G}_2(u, v) = \frac{1}{\sqrt{2}} \begin{bmatrix} -\sqrt{u+v} \\ \sqrt{u-v} \end{bmatrix}, \quad \mathbf{G}'_2(u, v) = \frac{1}{2\sqrt{2}} \begin{bmatrix} -1/\sqrt{u+v} & -1/\sqrt{u+v} \\ 1/\sqrt{u-v} & -1/\sqrt{u-v} \end{bmatrix}$

$\mathbf{G}_3(u, v) = \frac{1}{\sqrt{2}} \begin{bmatrix} \sqrt{u+v} \\ -\sqrt{u-v} \end{bmatrix}, \quad \mathbf{G}'_3(u, v) = \frac{1}{2\sqrt{2}} \begin{bmatrix} 1/\sqrt{u+v} & 1/\sqrt{u+v} \\ -1/\sqrt{u-v} & 1/\sqrt{u-v} \end{bmatrix}$

$\mathbf{G}_4(u, v) = \frac{1}{\sqrt{2}} \begin{bmatrix} -\sqrt{u+v} \\ -\sqrt{u-v} \end{bmatrix}, \quad \mathbf{G}'_4(u, v) = \frac{1}{2\sqrt{2}} \begin{bmatrix} -1/\sqrt{u+v} & -1/\sqrt{u+v} \\ -1/\sqrt{u-v} & 1/\sqrt{u-v} \end{bmatrix}$

6.3.15 (p. 416) From solving  $x = r \cos \theta$ ,  $y = r \sin \theta$  for  $\theta = \arg(x, y)$ . Each equation is satisfied by angles that are not arguments of  $(x, y)$ , since none of the formulas identifies the quadrant of  $(x, y)$  uniquely. Moreover, (c) does not hold if  $x = 0$ .

6.3.16 (p. 416)  $\begin{bmatrix} x \\ y \end{bmatrix} = \mathbf{G}(u, v) = (u^2 + v^2)^{1/4} \begin{bmatrix} \cos[\frac{1}{2} \arg(u, v)] \\ \sin(\arg(u, v)/2) \end{bmatrix},$

where  $\beta - \pi/2 < \arg(u, v) < \beta + \pi/2$  and  $\beta$  is an argument of  $(a, b)$ ;

$$\mathbf{G}'(u, v) = \frac{1}{2(x^2 + y^2)} \begin{bmatrix} x & y \\ -y & x \end{bmatrix}$$

6.3.19 (p. 416) If  $\mathbf{F}(x_1, x_2, \dots, x_n) = (x_1^3, x_2^3, \dots, x_n^3)$ , then  $\mathbf{F}$  is invertible, but  $J\mathbf{F}(\mathbf{0}) = 0$ .

6.3.20 (p. 416) (a)  $\mathbf{A}(\mathbf{U}) = \begin{bmatrix} 1 \\ -1 \end{bmatrix} - \frac{1}{25} \begin{bmatrix} 5 & 5 \\ 3 & 8 \end{bmatrix} \begin{bmatrix} u + 5 \\ v - 4 \end{bmatrix}$

$$(b) \mathbf{A}(\mathbf{U}) = \begin{bmatrix} 1 \\ 1 \end{bmatrix} + \frac{1}{6} \begin{bmatrix} 4 & -2 \\ -3 & 3 \end{bmatrix} \begin{bmatrix} u-2 \\ v-3 \end{bmatrix}$$

$$(c) \mathbf{A}(\mathbf{U}) = \begin{bmatrix} 0 \\ 1 \\ 1 \end{bmatrix} + \begin{bmatrix} 0 & -1 & 1 \\ -1 & 1 & 0 \\ 1 & 0 & 0 \end{bmatrix} \begin{bmatrix} u-1 \\ v-1 \\ w-2 \end{bmatrix}$$

$$(d) \mathbf{A}(\mathbf{U}) = \begin{bmatrix} 1 \\ \pi/2 \\ \pi \end{bmatrix} + \begin{bmatrix} 0 & -1 & 0 \\ 1 & 0 & 0 \\ 0 & 0 & -1 \end{bmatrix} \begin{bmatrix} u \\ v+1 \\ w \end{bmatrix}$$

$$6.3.21 \text{ (p. 417)} \mathbf{G}'(x, y, z) = \begin{bmatrix} \cos \theta \cos \phi & \sin \theta \cos \phi & \sin \phi \\ -\frac{\sin \theta}{r \cos \phi} & \frac{\cos \theta}{r \cos \phi} & 0 \\ -\frac{1}{r} \cos \theta \sin \phi & -\frac{1}{r} \sin \theta \sin \phi & \frac{1}{r} \cos \phi \end{bmatrix}$$

$$6.3.22 \text{ (p. 417)} \mathbf{G}'(x, y, z) = \begin{bmatrix} \cos \theta & \sin \theta & 0 \\ -\frac{1}{r} \sin \theta & \frac{1}{r} \cos \theta & 0 \\ 0 & 0 & 1 \end{bmatrix}$$

**Section 6.4 pp. 431–434**

$$6.4.1 \text{ (p. 431)} (a) \begin{bmatrix} u \\ v \end{bmatrix} = \frac{1}{2} \begin{bmatrix} -3 & 4 \\ 1 & -2 \end{bmatrix} \begin{bmatrix} x \\ y \end{bmatrix}$$

$$(b) \begin{bmatrix} u \\ v \\ w \end{bmatrix} = -\frac{1}{2} \begin{bmatrix} 3 & 3 \\ -1 & 2 \\ 2 & 3 \end{bmatrix} \begin{bmatrix} x \\ y \end{bmatrix} \quad (c) \begin{bmatrix} u \\ v \end{bmatrix} = \frac{1}{5} \begin{bmatrix} 2 & -1 \\ -1 & 3 \end{bmatrix} \begin{bmatrix} -y + \sin x \\ -x + \sin y \end{bmatrix}$$

$$(d) u = -x, v = -y, z = -w$$

$$6.4.3 \text{ (p. 431)} f_i(\mathbf{X}, \mathbf{U}) = \left( \sum_{j=1}^n a_{ij}(x_j - x_{j0}) \right)^r - (u_i - u_{i0})^s, \quad 1 \leq i \leq m, \text{ where } r$$

and  $s$  are positive integers and not all  $a_{ij} = 0$ . (a)  $r = s = 3$ ; (b)  $r = 1, s = 3$ ; (c)  $r = s = 2$

$$6.4.4 \text{ (p. 431)} u_x(1, 1) = -\frac{5}{8}, u_y(1, 1) = -\frac{1}{2}$$

$$6.4.5 \text{ (p. 431)} u_x(1, 1, 1) = \frac{5}{8}, u_y(1, 1, 1) = -\frac{9}{8}, u_z(1, 1, 1) = \frac{1}{2}$$

$$6.4.6 \text{ (p. 431)} (a) u(1, 2) = 0, u_x(1, 2) = u_y(1, 2) = -4$$

$$(b) u(-1, -2) = 2, u_x(-1, -2) = 1, u_y(-1, -2) = -\frac{1}{2}$$

$$(c) u(\pi/2, \pi/2) = u_x(\pi/2, \pi/2) = u_y(\pi/2, \pi/2) = 0$$

$$(d) u(1, 1) = 1, u_x(1, 1) = u_y(1, 1) = -1$$

$$6.4.7 \text{ (p. 431)} (a) u_1(1, 1) = 1, \quad \frac{\partial u_1(1, 1)}{\partial x} = 5, \quad \frac{\partial u_1(1, 1)}{\partial y} = 2$$

$$u_2(1, 1) = 2, \frac{\partial u_2(1, 1)}{\partial x} = -14; \frac{\partial u_2(1, 1)}{\partial y} = -2$$

$$(b) u_k(0, \pi) = (2k + 1)\pi/2, \frac{\partial u_k(0, \pi)}{\partial x} = 0, \frac{\partial u_k(0, \pi)}{\partial y} = -1, \quad k = \text{integer}$$

$$6.4.8 \text{ (p. 432)} \frac{1}{5} \begin{bmatrix} -1 & -2 & 1 \\ -1 & -2 & 1 \end{bmatrix} \quad 6.4.9 \text{ (p. 432)} u'(0) = 3, v'(0) = -1$$

$$6.4.10 \text{ (p. 432)} \frac{1}{6} \begin{bmatrix} 5 & 5 \\ -5 & -5 \\ 6 & 6 \end{bmatrix}$$

$$6.4.11 \text{ (p. 432)} \mathbf{U}_1(1, 1) = \begin{bmatrix} 3 \\ 1 \end{bmatrix}, \mathbf{U}'_1(1, 1) = \begin{bmatrix} 1 & 3 \\ -1 & 2 \end{bmatrix};$$

$$\mathbf{U}_2(1, 1) = -\begin{bmatrix} 3 \\ 1 \end{bmatrix}, \mathbf{U}'_2(1, 1) = -\begin{bmatrix} 1 & 3 \\ -1 & 2 \end{bmatrix}$$

$$6.4.12 \text{ (p. 432)} u_x(0, 0, 0) = 2, v_x(0, 0, 0) = w_x(0, 0, 0) = -2$$

$$6.4.13 \text{ (p. 433)} y_x = -\frac{\frac{\partial(f, g, h)}{\partial(x, z, u)}}{\frac{\partial(f, g, h)}{\partial(y, z, u)}}, y_v = -\frac{\frac{\partial(f, g, h)}{\partial(v, z, u)}}{\frac{\partial(f, g, h)}{\partial(y, z, u)}}, z_x = -\frac{\frac{\partial(f, g, h)}{\partial(y, x, u)}}{\frac{\partial(f, g, h)}{\partial(y, z, u)}},$$

$$z_v = -\frac{\frac{\partial(f, g, h)}{\partial(y, v, u)}}{\frac{\partial(f, g, h)}{\partial(y, z, u)}}, u_x = -\frac{\frac{\partial(f, g, h)}{\partial(y, z, x)}}{\frac{\partial(f, g, h)}{\partial(y, z, u)}}, u_v = -\frac{\frac{\partial(f, g, h)}{\partial(y, z, v)}}{\frac{\partial(f, g, h)}{\partial(y, z, u)}}$$

$$6.4.14 \text{ (p. 433)} x = -2y - u, z = -2v; x = -2y - u, v = -\frac{z}{2}; y = -\frac{x}{2} - \frac{u}{2},$$

$$z = -2v; y = -\frac{x}{2} - \frac{u}{2}, v = -\frac{z}{2}; z = -2v, u = -x - 2y; u = -x - 2y, v = -\frac{z}{2}$$

$$6.4.15 \text{ (p. 433)} y_x(1, -1, -2) = -\frac{1}{2}, v_u(1, -1, -2) = 1$$

$$6.4.16 \text{ (p. 433)} u_w(0, -1) = \frac{5}{6}, u_y(0, -1) = 0, v_w(0, -1) = -\frac{5}{6}, v_y(0, -1) = 0,$$

$$x_w(0, -1) = 1, x_y(0, -1) = -1$$

$$6.4.18 \text{ (p. 434)} u_x(1, 1) = 0, u_y(1, 1) = 0, v_x(1, 1) = -1, v_y(1, 1) = -1, u_{xx}(1, 1) = 2,$$

$$u_{xy}(1, 1) = 1, u_{yy}(1, 1) = 2, v_{xx}(1, 1) = -2, v_{xy}(1, 1) = -1, v_{yy}(1, 1) = -2$$

$$6.4.19 \text{ (p. 434)} u_x(1, -1) = 0, u_y(1, -1) = \frac{1}{2}, v_x(1, -1) = -\frac{1}{2}, v_y(1, -1) = 0,$$

$$u_{xx}(1, -1) = -\frac{1}{8}, u_{xy}(1, -1) = \frac{1}{8}, u_{yy}(1, -1) = \frac{1}{8}, v_{xx}(1, -1) = -\frac{1}{8},$$

$$v_{xy}(1, -1) = -\frac{1}{8}, v_{yy}(1, -1) = \frac{1}{8}$$

## Section 7.1 pp. 459–462

7.1.2 (p. 459) (a) 28 (b)  $\frac{1}{4}$  7.1.6 (p. 460)  $3(b-a)(d-c), 0$  7.1.13 (p. 460)  $\{(m, n) \mid m, n = \text{integers}\}$

## Section 7.2 pp. 480–484

7.2.1 (p. 480) (a) 12 (b)  $\frac{79}{20}$  (c)  $-1$  (d)  $(1 - \log 2)/2$

7.2.5 (p. 481) (a)  $\frac{7}{4}$  (b) 17 (c)  $\frac{2}{3}(\sqrt{2} - 1)$  (d)  $1/4\pi$

7.2.7 (p. 481) (a)  $\frac{3}{8}, \frac{5}{8}$  (b)  $\frac{3}{8}, \frac{5}{8}$  7.2.8 (p. 482) (a)  $\frac{3}{4}, \frac{5}{4}$  (b)  $\frac{3}{4}(z + \frac{1}{2}), \frac{5}{4}(z + \frac{1}{2})$  (c)  $z + \frac{1}{2}, 1$

7.2.11 (p. 482) (a)  $-285$  (b) 0 (c) 0 (d)  $\frac{1}{4}(e - \frac{5}{2})$

7.2.12 (p. 483) (a) 324 (b)  $\frac{1}{6}$  (c) 1 7.2.13 (p. 483)  $\frac{52}{15}$

7.2.14 (p. 483) (a) 36 (b) 1 (c)  $\frac{64}{3}$  (d)  $(e^6 + 17)/2$

7.2.17 (p. 483) (a)  $\frac{2}{27}$  (b)  $\frac{1}{2}(e - \frac{5}{2})$  (c)  $\frac{1}{24}$  (d)  $\frac{1}{36}$

7.2.18 (p. 483) (a)  $16\pi$  (b)  $\frac{1}{6}$  (c)  $\frac{128}{21}$  (d)  $\frac{\pi}{2}$

7.2.19 (p. 484) (a)  $\frac{1}{2}(b_1 - a_1) \cdots (b_n - a_n) \sum_{j=1}^n (a_j + b_j)$

(b)  $\frac{1}{3}(b_1 - a_1) \cdots (b_n - a_n) \sum_{j=1}^n (a_j^2 + a_j b_j + b_j^2)$

(c)  $2^{-n}(b_1^2 - a_1^2) \cdots (b_n^2 - a_n^2)$

7.2.20 (p. 484)  $\int_{-\sqrt{3}/2}^{\sqrt{3}/2} dx \int_{1/2}^{\sqrt{1-x^2}} f(x, y) dy$  7.2.22 (p. 484)  $\frac{1}{2}$

## Section 7.3 pp. 514–517

7.3.1 (p. 514) Let  $S_1$  and  $S_2$  be dense subsets of  $\mathbb{R}$  such that  $S_1 \cup S_2 = \mathbb{R}$ .

7.3.7 (p. 514) (a)  $-1; c$  (constant); 1 7.3.9 (p. 515)  $(u_2 - u_1)(v_2 - v_1)/|ad - bc|$

7.3.10 (p. 515)  $\frac{5}{6}$  7.3.14 (p. 515) (a)  $\frac{4}{9}$  (b)  $\log \frac{5}{2}$  7.3.15 (p. 516) 3

7.3.16 (p. 516)  $\frac{1}{2}$  7.3.17 (p. 516)  $\frac{5}{4}e(e - 1)$

7.3.18 (p. 516)  $\frac{4}{3}\pi abc$  7.3.19 (p. 516)  $2\pi(e^{25} - e^9)$  7.3.20 (p. 516)  $16\pi/3$

7.3.21 (p. 516)  $21/64$

7.3.22 (p. 516) (a)  $(\pi/8)\log 5$  (b)  $(\pi/4)(e^4 - 1)$  (c)  $2\pi/15$

7.3.23 (p. 517)  $\pi^2 a^4/2$

7.3.24 (p. 517) (a)  $(\beta_1 - \alpha_1) \cdots (\beta_n - \alpha_n)/|\det(\mathbf{A})|$  7.3.25 (p. 517)  $|a_1 a_2 \cdots a_n| V_n$

## Index

### A

Abel's test, 219  
Abel's theorem, 273, 279  
Absolute convergence, 215  
    of an improper integral, 160  
    of a series of constants, 215  
    of a series of functions, 247  
Absolute integrability, 160  
Absolute uniform convergence, 247, 255  
    (Exercises 4.4.17 and 4.4.20),  
    256 (Exercise 4.4.21)  
    of a power series, 257  
Absolute value, 2  
Addition of power series, 267  
Adjoint matrix, 370  
Affine transformation, 380  
Alternating series, 203  
    test, 203, 219  
Analytic transformation, 416 (Exercise 6.3.17)  
Angle between two vectors, 286  
Antiderivative, 143, 150 (Exercise 3.3.16)  
Archimedean property, 5  
Area under a curve, 116  
Argument, 398  
    branch of, 409, 410, 415 (Exercise 6.3.14)  
Ascoli–Arzela theorem, 543  
Associative laws  
    for the real numbers, 2 (see p. 1)  
    for vector addition, 283

### B

Bessel function, 277 (Exercise 4.5.11)

Binomial coefficient, 17 (Exercise 1.2.19),  
    102, 194 (Exercise 4.1.35)  
Binomial series, 266  
Binomial theorem, 17 (Exercise 1.2.19)  
Bolzano–Weierstrass theorem, 27, 294,  
    301 (Exercise 5.1.22)  
Bound  
    lower, 7  
    upper, 3  
Boundary, 526  
    point, 289, 526  
    of a set, 23, 289  
Bounded convergence theorem, 243  
Bounded function, 47, 60, 313  
Boundedness of a continuous function  
    on a closed interval, 62, 199  
    on a compact set, 313  
Boundedness of an integrable function,  
    119  
    on a metric space, 537  
Bounded sequence, 181, 197, 292  
Bounded set  
    above, 3, 313  
    below, 7, 313  
Bounded variation, 134–135 (Exercises 3.2.7,  
    3.2.9, 3.2.10)  
Branch  
    of an argument, 409, 415  
    of an inverse, 409

### C

$C[a,b]$ , 521  
    equicontinuous subset of, 541

- uniformly bounded subset of, 541
- Cartesian product, 31, 435
- Cauchy product of series, 226, 233 (Exercise 4.3.40), 280 (Exercise 4.5.32)
- Cauchy sequence, 527
- Cauchy's convergence criterion
  - for sequences of real numbers, 190
  - for sequences of vectors, 292
  - for series of real numbers, 204
- Cauchy's root test, 215
- Cauchy's uniform convergence criterion
  - for sequences, 239
  - for series, 246
- Chain rule, 77, 340, 388
- Change of variable, 145, 147
  - in an improper integral, 164
  - in a multiple integral, 496
    - formulation of the rule for, 494
  - in an ordinary integral, 145, 147
- Changing the order of integration, 478
- Characteristic function, 70 (Exercise 2.2.9), 485
- Closed
  - under scalar multiplication, 519
  - under vector addition, 519
- Closed interval, 23
- Closed  $n$ -ball, 291
- Closed set, 21, 289, 525
- Closure of a set, 23, 289
- Cofactor, 370
  - expanding a determinant in, 371–372
- Commutative laws
  - for the reals, 2 (See p. 1)
  - for vector addition, 283
- Compact set, 20, 293, 537
- Comparison test
  - for improper integrals, 156
  - for series, 206
- Complement of a set, 20
- Complete metric space, 527
- Completeness axiom, 4
- Complete ordered field, 4
- Component function, 311
- Components, 284 (see p. 281)
  - of a vector-valued function, 311, 362
- Composite function, 58, 311
  - continuity of, 59, 311
  - differentiability of, 77, 340
  - higher derivatives of, 345
  - Taylor polynomial of, 109–110 (Exercise 2.5.11)
- Composition of functions, 58
- Conditional convergence
  - of an improper integral, 162
  - of a series, 217
- Conditionally integrable, 162
- Connected metric space, 549 (Exercise 8.3.2)
- Connected set, 295
  - polygonally, 296
- Containment of a set, 19
- Content, 453
  - of a coordinate rectangle, 437
  - of a set, 485
  - zero, 448, 514 (Exercise refexer:7.3.2)
- Continuity, 54, 302
  - of a composite function, 59, 311
  - of a differentiable function, 76, 325
  - of a function of  $n$  variables, 309
  - of a function of one variable, 54
  - on an interval, 55
    - from the left, 54
  - of a monotonic function, 67
  - piecewise, 56
    - from the right, 54
  - on a set, 56, 311
  - of a sum, difference, product, and quotient, 57, 311
  - in terms of sequences, 198
  - of a transformation, 379
  - uniform, 64, 66, 314, 392 (Exercise 6.2.10)
  - of a uniform limit, 242
  - of a uniformly convergent series, 250
- Continuous function 54, 309
  - boundedness of, 62, 313
  - extreme values of on a closed interval, 62
  - integrability of, 133
  - intermediate values of, 63, 313
  - on a metric space, 545
- Continuous transformation, 379



- Continuously differentiable, 73, 80, 329, 385, 409
- Contraction mapping theorem, 547
- Convergence
- absolute
    - of an improper integral, 160
    - of a series of constants, 215
  - absolute uniform, 247
  - conditional
    - of a series, 217
    - of an improper integral, 162
  - of an improper integral, 152
  - of an infinite series, 201
  - interval of, 258
  - pointwise
    - of a sequence of functions, 234, 238
    - of a series of functions, 244
  - of a power series, 257
  - radius of, 258
  - of a sequence in a metric space, 526
  - of a sequence in  $\mathbb{R}^n$ , 292
  - of a sequence of real numbers, 179
  - of a series of constants, 200
  - of a sum, difference, or product of sequences, 184
  - of a Taylor series, 264
  - uniform, 246
    - of a sequence, 237
    - of a series, 246
- Coordinate cube, 437
- degenerate, 437
  - nondegenerate, 437
- Coordinate rectangle, 437
- Coordinates,
  - polar, 397, 502, 505
  - spherical, 507
- Covering, open, 25, 293, 536
- Cramer's rule, 373
- Critical point, 81, 335
- Curve, differentiable, 453
- D**
- Decreasing sequence, 182
- Dedekind cut, 9 (Exercise 1.1.8)
- Dedekind's theorem, 9 (Exercise 1.1.8)
- Defined inductively, 12
- Degree
  - of a homogeneous polynomial, 352
  - of a polynomial, 98
- Deleted  $\epsilon$ -neighborhood, 22
- Deleted neighborhood, 525
- Dense set, 6, 29 (Exercise 1.3.22), 70 (Exercise 2.2.10)
- Density of the rationals, 6, 392 (Exercise 6.2.11)
- Density of the irrationals, 6
- Denumerable set, 176
- Derivative, 73
  - of a composite function, 77
  - directional, 317
  - infinite, 88 (Exercise 2.3.26)
  - of an inverse function, 86 (Exercise 2.3.14)
  - left-hand, 79
  - $n$ th, 73
  - one-sided, 79
  - ordinary, 317
  - partial, 317
  - of a power series, 261–262
  - right-hand, 79
  - $r$ th order, 319
  - second, 73
  - of a sum, difference, product, and quotient, 77
  - zeroth, 73
- Determinant, 368 (see p. 369)
  - expanding in cofactors, 371–372
  - of a product of square matrices, 370
- Diameter of a set, 292, 586
- Difference quotient, 73
- Differentiability
  - of a composite function, 340
  - continuous, 329
  - of a function of one variable, 73
  - of a function of several variables, 323
  - of the limit of a sequence, 243
  - of a power series, 260–262
  - of a series, 252
- Differentiable 73, 323
  - continuously, 73, 80, 409
  - curve, 453

- function, continuity of, 76, 325, 385
  - on an interval, 80
  - on a set, 73
  - surface, 453
  - transformation, 380
  - vector-valued function, 339
  - Differential, 326
    - higher, 348
    - of a linear transformation, 367
    - matrix, 367, 381
    - of a real-valued function, 326
    - of a sum, difference, product, and quotient, 328
    - of a transformation, 381
  - Differential equation, 170–171
    - (Exercises 3.4.27–3.4.29)
  - Directional derivative, 317
  - Dirichlet's test
    - for improper integrals, 163
    - for series of constants, 217
    - for uniform convergence of series, 248
  - Disconnected set, 295
  - Discontinuity
    - jump, 56
    - removable, 58
  - Discrete metric, 519
  - Disjoint sets, 20
  - Distance
    - in a metric space, 518
    - from a point to a set, 301
      - (Exercise 5.1.24)
    - between subsets of a metric space, 549
      - (Exercise 8.3.3)
    - between two sets, 301
      - (Exercise 5.1.25)
    - between two vectors, 283
  - Distributive law, 2 (see p. 1)
  - Divergence, unconditional, 233
    - (Exercise 4.3.38)
  - Divergent improper integral, 152
  - Divergent sequence, 179
  - Divergent series, 201
  - Domain of a function, 31 (see p. 30), 545
  - Double integral, 438
- E**
- Edge lengths of a coordinate rectangle, 437
  - Elementary matrix, 488
  - Empty set, 4
  - Entries of a matrix, 364
  - $\epsilon$ -neighborhood, 21, 289, 525
  - $\epsilon$ -net, 539
  - Equicontinuous subset of  $C[a, b]$ , 541
  - Equivalent metrics, 530
  - Error in approximating derivatives, 112
    - (Exercises 112–112)
  - Euclidean  $n$ -space, 282 (see p. 281)
  - Euler's constant, 230 (Exercise 4.3.14)
  - Euler's theorem, 357–358 (Exercise 2.4.8)
  - Existence of an improper integral, 152
  - Existence theorem, 420
  - Expanding a determinant, 362–372
  - Exponential function, 70 (Exercise 2.2.12), 72 (Exercise 2.2.33), 228, 273
  - Extended mean value theorem, 106
  - Extended reals, 7,
  - Exterior point, 289, 526
  - Exterior of a set, 23, 289, 526
- F**
- Faa di Bruno's formula, 109
    - (Exercise 2.5.11)
  - Fibonacci numbers, 17 (Exercise 1.2.17)
  - Field
    - complete ordered, 4
    - ordered, 2
    - properties, 2 (see p. 1)
  - Finite real, 7
  - First mean value theorem for integrals, 139
  - Forward differences, 104, 71 (Example 2.2.18), 112 (Exercises 2.5.19–2.5.22)
  - Fredholm's integral equation, 548
  - Function 31, 32
    - absolutely integrable, 160
    - Bessel, 277 (Exercise 277)
    - bounded, 47, 60, 313
      - above, 60, 313
      - below, 60, 313

- of bounded variation, 134 (Exercise 3.2.7)
  - characteristic, 70 (Exercise 2.2.9), 485
  - composite, 58, 311
  - decreasing, 44
  - differentiable at a point, 73, 323
  - domain of, 31, 32
  - exponential, 70 (Exercise 2.2.12), 72  
(Exercise 2.2.33), 227, 273
  - generating, 278 (Exercise 4.5.26)
  - homogeneous, 357 (Exercise 5.4.8)
  - increasing, 44
  - infimum of, 55, 313
  - inverse of, 68
  - linear, 325
  - locally integrable, 152
  - maximum of, 60
  - monotonic, 44, 67
  - nondecreasing, 44
  - nonincreasing, 44
  - nonoscillatory at a point, 162
  - $n$ th power of, 33
  - oscillation of, 171
  - piecewise continuous, 56
  - range of, 31, 32
  - rational, 33, 232, (Exercise 4.3.28),  
276 (Exercise 4.5.4)
  - real-valued, 302
  - restriction of, 399
  - Riemann integrable, 114, 438
  - Riemann–Stieltjes integrable, 125
  - strictly monotonic, 44
  - supremum of, 313
  - value of, 31, 32
  - vector-valued, 311
- Functions,
- composition of, 58, 311
  - difference of, 32
  - product of, 32
  - quotient of, 32
  - sum of, 32
- Fundamental theorem of calculus, 143
- G**
- Generalized mean value theorem, 83
- Generating function, 278 (Exercise 4.5.26)
- Geometric series, 202
- Grouping terms of series, 220
- H**
- Heine–Borel property,
- Heine–Borel theorem, 172, 66, 172, 293
- Higher derivatives of a composite function, 345
- Higher differential, 348
- Homogeneous function, 357 (Exercise 5.4.8),  
359 (Exercise 5.4.23)
- Homogeneous polynomial, 359 (Exercise 5.4.22),
- Homogeneous system, 375
- Hypercube, 295 (see p. 294)
- Hölder’s inequality, 521
- I**
- Identity matrix, 370
- Image, 394
- Implicit function theorem, 420, 423
- Improper integrability, 146
- Improper integral, 152
- absolutely convergent, 160
  - change of variable in, 164
  - conditionally convergent, 162
  - convergence of, 152
  - divergence of, 152
  - existence of, 152
  - of a nonnegative function, 156
- Incompleteness of the rationals, 6
- Increasing sequence, 182
- Indeterminate forms, 91, 93–95
- Induction assumption, 12
- Induction proof, 12
- Inequality,
- Hölder, 521
  - Minkowski, 522
  - Schwarz, 284
  - triangle, 2, 285
- Infimum
- of a function, 60, 313
  - of a set, 7
  - existence and uniqueness of, 7, 9  
(Exercise 1.1.6)

- Infinite derivative, 88 (Exercise 2.3.26)  
 Infinite limits, 42, 306, 317, 316 (Exercise 5.2.6)  
 Infinite sequence, 179  
   in a metric space, 526  
 Infinite series, 210, 244  
   convergence of, 201  
   integrability of, 251  
   oscillatory, 201  
 Infinity norm, 496, 523, 524  
 Inner product, 284  
 Instantaneous  
   rate of change, 74  
   velocity, 74  
 Integrability  
   conditional, 162  
   of a continuous function, 133  
   of a function of bounded variation,  
     134 (Exercise 3.2.7)  
   improper, 152  
   of an infinite series, 251  
   local, 152  
   of a monotonic function, 133  
   of a power series, 264  
 Integrable  
   Riemann, 114, 438  
   Riemann–Stieltjes, 125  
 Integral  
   over an arbitrary set in  $\mathbb{R}^n$ , 452  
   of a constant times a function, 136,  
     456  
   double, 439  
   improper, 151  
   iterated, 462  
   lower  
     for Riemann integral, 120, 442  
     for Riemann–Stieltjes integral 128  
       (Exercise 3.1.17)  
   multiple, 439  
   ordinary, 439  
   of a product, 138, 456  
   proper, 153  
   over a rectangle in  $\mathbb{R}^n$ , 436 (See p. 435)  
   Riemann, 114, 438  
   Riemann–Stieltjes, 125, 127 (Exercise  
     3.1.16), 135 (Exercises 3.2.8–  
     3.2.10), 151 (Exercise 3.3.23)  
   over subsets of  $\mathbb{R}^n$ , 436 (See p. 435),  
     450, 452, 471–472  
   of a sum, 136, 456  
   test, 207  
   triple, 439  
 Integration by parts, 144  
   for Riemann–Stieltjes integrals, 135  
     (Exercise 3.2.8)  
 Interior of a set, 21, 289  
 Interior point, 21, 289, 525  
 Intermediate value theorem  
   for continuous functions, 63, 313  
   for derivatives 82  
 Intersection of sets, 20  
 Interval  
   closed, 23  
   half closed, 23  
   half open, 23  
   open, 21  
   semi-infinite, 21, 23  
 Interval of convergence, 258  
   for derivatives, 82  
 Inverse function, 68  
   branch of, 409  
   derivative of, 86 (Exercise 2.3.14)  
   of a function restricted to a set, 399  
   of a matrix, 370  
   of a transformation, 396  
 Inverse function theorem, 412  
 Invertible, locally, 400  
 Invertible transformation, 396  
 Irrational number, 6  
 Isolated point, 23, 289, 526  
 Iterated integral, 462  
 Iterated logarithm, 97 (Example 2.4.42),  
   167 (Exercise 3.4.10), 208 230  
   (Exercise 4.3.11), 230 (Exercise 4.3.16)
- J**  
 Jacobian, 384, 426  
 Jordan content, 485  
   changed by linear transformation, 488

Jordan measurable set, 485, 488

Jump discontinuity, 56

## L

Lebesgue measure zero, 175, 177 (Exercises 3.5.7, 3.5.8)

Lebesgue's existence criterion, 176

Left limit inferior, 47

Left limit superior, 47

Left-hand derivative, 79

Left-hand limit, 38

Legendre polynomial, 278 (Exercise 4.5.27)

Leibniz's rule, 86, (Exercise 2.3.12)

Length of a vector, 283

l'Hospital's rule, 88

Limit of a real-valued function, 302

Limit

along a curve, 315 (Exercise 5.2.3)

in the extended reals, 43

inferior of a sequence, 188

left, 47

infinite, 42, 306, 316 (Exercise 5.2.6)

at infinity, 307, 316 (Exercise 5.2.6)

left-hand, 38

one-sided, 37, 40

point, 23, 289, 526

pointwise, 234, 238, 244

at  $\pm\infty$ , 40

of a real-valued function

as  $x$  approaches  $x_0$ , 34

as  $x$  approaches  $\infty$ , 40

as  $x$  approaches  $-\infty$ , 50 (Exercise 2.1.14)

right-hand, 39

of a sequence, 179, 292

uniqueness of, 35, 305

of a sum, product, or quotient, 35, 305

superior, left, 47

superior of a sequence, 188

uniform, 237

uniqueness of, 35, 305

Line segments in  $\mathbb{R}^n$ , 288

Line, parametric representation of, 288–289

Linear function, 325

Linear transformation, 362

change of content under, 490

differential of, 367

matrix of, 363

Lipschitz condition, 84, 87 (Exercise 2.3.24), 140

Local extreme point, 80, 334

Local extreme value, 80

Local integrability, 152

Local maximum point, 80, 334

Local minimum point, 80, 334

Locally invertible, 400

Lower bound, 7

Lower integral, 120, 442

Lower sum, 120, 442

## M

Maclaurin's series, 264

Magnitude, 2

Main diagonal of a matrix, 370

Mathematical induction, 10, 13

Matrices

product of, 364

sum of, 364

Matrix

adjoint, 370

of a composition of linear transformations, 366

differential, 367, 381

elementary, 488

identity, 370

inverse, 370

of a linear transformation, 363

main diagonal of, 370

nonsingular, 370

norm of, 368

scalar multiple of, 364

singular, 370

square, 368 (See p. 369)

transpose of, 370

Maximum value, local, 80

Maximum of a function, 60

Mean value theorem, 83, 347  
extended, 106

- generalized, 83
  - for integrals, 138, 144
  - Metric, 518
    - discrete, 519
    - induced by a norm, 520
  - Metrics, equivalent, 530
  - Metric space, 518
    - complete, 527
    - connected, 549 (Exercise 8.3.2)
  - Minimum of a function, 60
  - Minimum value, local, 80
  - Minkowski's inequality, 522
  - Monotonic function, 44, 67, 84
    - integrability of, 133
  - Monotonic sequence, 182
  - Multinomial coefficient, 322, 336 (Exercise 5.3.12)
  - Multiple integral, 439
  - Multiplication
    - of matrices, 364
    - of series, 223
    - scalar, 519
  - Multiplicity of a zero, 87 (Exercise 2.3.21), 108 (Exercises 2.5.5–2.5.7)
- N**
- Natural numbers, 10
  - $n$ -ball, 290–291
  - Negative definite polynomial, 353
  - Negative semidefinite polynomial, 353
  - Neighborhood, 21, 289, 525
    - deleted, 22, 525
    - deleted  $\epsilon$ , 22
    - $\epsilon$ , 21
  - Nested sets, 292, 530
    - principle of, 292, 530
  - Nondecreasing sequence, 182
  - Nondegenerate coordinate cube, 437
  - Nondenumerable set, 176
  - Nonempty set, 4
  - Nonincreasing sequence, 182
  - Nonoscillatory at a point, 162
  - Nonsingular matrix, 370
  - Nontrivial solution, 375
  - Norm
    - infinity, 496, 523, 524
    - of a matrix, 368
    - metric induced by, 520
    - of a partition, 114, 437
    - on a vector space, 519
  - Normed vector space, 519
  - $n$ th derivative, 73
  - $n$ th partial sum of a series, 201
  - $n$ th term of a series, 201
  - Number, natural, 10
  - Number, prime, 15
- O**
- One-sided derivative, 79
  - One-sided limit, 37
  - One-to-one transformation, 396
  - Open ball, 525
  - Open covering, 25, 293, 536
  - Open interval, 21
  - Open  $n$ -ball, 290
  - Open set, 21, 289, 525
  - Ordered field, 2
    - complete, 4
  - Order relation, 2
  - Ordinary derivative, 317
  - Ordinary integral, 439
  - Origin of  $\mathbb{R}^n$ , 283
  - Oscillation of a function, 171
    - at a point, 172
  - Oscillatory infinite series, 201
- P**
- Parametric representation of a line, 288, 289
  - Partial derivative, 317
    - $r$ th order, 319
  - Partial sums, 244
  - Partition, 114, 437
    - norm of, 114, 437
    - points, 114
    - refinement of, 114, 438
  - Path, polygonal, 296
  - Peano's postulates, 10–11
  - Piecewise continuous function, 56
  - Point, 19

- boundary, 23, 289, 526
- critical, 81, 335
- exterior, 23, 289, 526
  - at infinity, 7
  - interior, 21, 289
  - isolated, 23, 289, 526
  - limit, 23, 289, 526
  - local extreme, 80, 334
  - local maximum, 80, 334
  - local minimum, 80, 334
  - in terms of sequences, 197
- Pointwise convergence
  - of a sequence of functions, 234, 238
  - of a series, 244
- Pointwise limit, 234, 238, 244
- Polar coordinates, 397, 502, 505
- Polygonal path, 296
- Polygonally connected, 296
- Polynomial, 33, 98
  - homogeneous, 352
  - negative definite, 353
  - negative semidefinite, 353
  - positive definite, 353
  - positive semidefinite, 353
  - semidefinite, 353
  - Taylor, 99, 351
- Power series, 257
  - arithmetic operations with, 267
  - continuity of, 260–261
  - convergence of, 257
  - differentiability of, 260–261
  - integration of, 264
  - of a product, 268
  - of a reciprocal, 271
  - of a quotient, 269
  - uniqueness of, 263
- Prime, 15
- Principal value, 155
- Principle of mathematical induction, 11, 14
- Principle of nested sets, 530
- Product
  - Cartesian, 31, 436 (see p. 435)
  - Cauchy, 226, 233 (Example 4.3.40)
  - inner, 284
  - of matrices, 364
  - of power series, 268
  - of series, 223
- Proper integral, 153
- R**
- $\mathbb{R}^n$ , 282 (see p. 281)
- $r$ th order partial derivative, 319
- Raabe's test, 212
- Radius of convergence, 258
- Range of a function, 31, 32, 545
- Ratio of a geometric series, 202
- Ratio test, 210
- Rational function, 33, 232 (Exercise 4.3.28), 276 (Exercise 4.5.4)
- Rational numbers, 2
  - density of, 6
  - incompleteness of, 6
- Real line, 19
- Real number system, 19
- Real-valued function,
  - of  $n$  variables, 302
  - of a real variable, 31
- Reals, extended, 7
- Rearrangement of series, 221
- Rectangle, coordinate, 437
- Refinement of a partition, 114, 438
- Region, 295, 297
- Region of integration, 476
- Regular transformation, 405
- Remainder in Taylor's formula, 405
- Removable discontinuity, 58
- Restriction of a function, 399
- Riemann integrable, 114, 438
- Riemann integral 114 (see p. 113), 438
  - uniqueness of, 125 (Exercise 3.1.1)
- Riemann sum, 114, 438
- Riemann–Stieltjes integral, 125
  - integration by parts for, 135 (Exercise 3.2.8)
- Riemann–Stieltjes sum, 125
- Right limit inferior, 53 (Exercise 2.1.39)
- Right limit superior, 53 (Exercise 2.1.39)
- Right-hand derivative, 79
- Right-hand limit, 39

Rolle's theorem, 82

## S

Scalar multiple, 282

Scalar multiplication, 519

Schwarz's inequality, 284

Secant plane, 332–333

Second derivative, 73

Second derivative test, 103

Second mean value theorem for integrals, 144

Sequence, 179, 526

bounded, 181, 292

bounded above, 181

bounded below, 181

Cauchy, 527

convergence of, 179, 292, 526

decreasing, 182

divergent, 179

to  $\pm\infty$ , 181

of functional values, 183

of functions,

pointwise, 234

increasing, 182

limit of, 179, 292

uniform, 237

limit inferior of, 188

limit superior of, 188

monotonic, 182

nondecreasing, 182

nonincreasing, 182

$n$ th term of, 179

terms of, 179

unbounded, 292

uniformly convergent, 237

## Series

alternating, 203

binomial, 266

Cauchy product of, 226, 233 (Exercise 4.3.40), 280 (Exercise 4.5.32)

differentiability of, 252

divergent, 201

geometric, 202

grouping terms in, 220

Maclaurin, 264

multiplication of, 223

of nonnegative terms, 205

partial sums of, 244

power, 257

product of, 218

rearrangement of, 221

Taylor, 223

term by term differentiation of, 252

term by term integration of, 251

uniformly convergent, 246

## Set

boundary of, 23, 289, 526

bounded, 7, 537

above, 3

below, 7

closed, 21, 289, 525

closure of, 23, 289, 526

compact, 26, 293, 537

complement of, 20

connected, 295

containment of, 19

content of, 485

dense, 6, 29 (Example 1.3.22), 70 (Exercise 2.2.10)

denumerable, 176

diameter of, 292, 537

disconnected, 295

empty, 4

exterior of, 23, 289, 526

interior of, 21, 289, 525

nondenumerable, 176

nonempty, 4

open, 21, 289, 525

singleton, 20

strict containment of, 20

subset of, 19

totally bounded, 539

unbounded below, 7

uniformly bounded, 541

universal, 19

## Sets

disjoint, 20

equality of, 19

intersection of, 20

nested, 530



- union of, 20
  - Simple zero, 108 (Exercise 2.5.5)
  - Singleton set, 20
  - Singular matrix, 370
  - Solution of a system of linear equations
    - nontrivial, 375
    - trivial, 375
  - Space
    - metric, 518
    - vector, 519
  - Spherical coordinates, 507
  - Square matrix, 368 (see p. 369)
  - Subsequence, 195
    - of a convergent sequence, 196, 527
  - Subset, 19
  - Subspace of a vector space, 519
  - Successor, 11
  - Sum
    - of matrices, 364
    - Riemann, 114, 438
      - lower, 120, 442
      - upper, 120, 442
    - Riemann–Stieltjes, 125
    - of vectors, 282
  - Summation by parts, 218
  - Supremum
    - of a function, 60, 313
    - of a set, 3
      - existence and uniqueness of, 4
  - Surface, 331
    - differentiable, 453
- T**
- Tangent
    - to a curve, 75
    - line, 75
    - plane, 332
  - Taylor polynomial, 99, 351
    - of a composite function, 109 (Exercise 2.5.11)
    - of a product, 109 (Exercise 2.5.10)
    - of a reciprocal, 110 (Exercise 2.5.12)
  - Taylor series, 264
    - convergence of, 264
  - Taylor’s theorem
    - for functions of  $n$  variables, 350
    - for a function of one variable, 104
  - Terms of a sequence, 179
  - Term by term differentiation, 252
  - Term by term integration, 251
  - Test
    - Cauchy’s root, 215
    - comparison
      - for improper integrals, 156
      - for series, 206
    - integral, 207
    - Raabe, 212
    - ratio, 210
    - second derivative, 103
  - Topological properties of  $\mathbb{R}^n$ , 282 (See p. 281)
  - Topological space, 26
  - Total variation, 134 (Exercise 3.2.7)
  - Totally bounded, 539
  - Transformation, 362
    - affine, 380
    - analytic, 416 (Exercise 6.3.17)
    - continuous, 379
    - differentiable, 339, 379–380
    - differential of, 381
    - inverse of, 396
    - invertible, 396, 396
    - linear, 362
    - one-to-one, 396
    - regular, 405
  - Transitivity of  $<$ , 31
  - Transpose of a matrix, 370
  - Triangle inequality, 2, 285
    - in a metric space, 518
  - Triple integral, 439
  - Trivial solution, 375
- U**
- Unbounded
    - above, 7
    - below, 7
    - sequence, 292
  - Unconditional divergence, 233 (Exercise 4.3.38)
  - Uniform continuity, 64, 72 (Exercises 2.2.30–2.2.32), 546

- for functions of  $n$  variables, 314, 392  
(Exercise 6.2.10)
  - Uniform convergence
    - properties preserved by
      - continuity, 242
      - differentiability, 243
      - integrability, 242
    - of a sequence, 236
    - of a series, 246
  - Uniformly bounded set in  $C[a, b]$ , 541
  - Union of sets, 20
  - Uniqueness
    - of infimum, 7
    - of limit, 35, 305, 527
    - of power series, 263
    - of prime factorization, 16 (Exercise 1.2.14)
    - of Riemann integral, 125 (Exercise 3.1.1)
    - of supremum, 4
  - Uniform continuity, 64, 66, 72 (Exercises 2.2.30–2.2.32)
  - Unit vector, 283
  - Universal set, 19
  - Upper bound, 3
  - Upper integral, 120, 442
  - Upper sum, 120, 442
- V**
- Value
    - of a function, 31, 32
    - local maximum, 80
    - local minimum, 80
    - principal, 155
  - Variation, total, 134 (Exercise 3.2.7)
  - Vector, 283, 519
  - Vector space, 283, 519
    - normed, 519
    - subspace of, 519
  - Vector sum, 282
  - Vector, unit, 283
  - Vector-valued function, 362 (see p. 361)
    - continuous, 379
    - differentiable, 379–380
- W**
- Weighted average, 139
- Weierstrass's test, 246
- Z**
- Zero content, 448, 460 (Exercises 7.1.14, 7.1.15), 461 (Exercises 7.1.16–7.1.19), 487, 514 (Exercise 7.3.2), 515 (Exercise 7.3.11)
  - Zero
    - multiplicity of, 108 (Exercises 2.5.5–2.5.7)
    - simple 108 (Exercise 2.5.5)
  - Zerth derivative, 73